

M160 Precision DC calibrator

user manual



ANALOG
DIGITAL



ADM Messtechnik GmbH & Co. KG · Zum Wartturm 9 · 63571 Gelnhausen
Tel. (06051) 916557-1 · sales@adm-messtechnik.de · www.adm-messtechnik.de

ADM Messtechnik GmbH & Co. KG

GERÄTE UND SYSTEME FÜR FORSCHUNG · ENTWICKLUNG · VERSUCH · SERVICE

Content

1. Introduction	6
1.1. Front panel overview	6
1.2. Rear panel overview	9
1.3. Options and accessories	9
1.4. Remote control	10
2. Getting started	12
2.1. Safety precautions	12
2.2. Power on and warm-up	13
2.3. Function setup	14
2.4. Signal output	14
2.5. What to do in case of failure	15
3. Menu reference	16
3.1. Information menu	16
3.2. Device menu	16
3.3. System menu	17
3.4. Interface menu	17
3.5. Calibration menu	17
3.6. Preset menu	18
4. Calibration examples	19
4.1. Voltage	19
4.2. Current	20
4.3. TC	21
4.4. Frequency	22
4.5. RTD	23
4.6. Resistance	24
4.7. Setting the step mode	24
4.8. Setting the value of output signal	26
4.9. Auxiliary parameter settings (Settings menu)	27
5. Performance verification	28
5.1. Required equipment	28
5.2. Verification procedure	28
6. Adjustment	31
6.1. Calibration menu structure	31
6.2. Calibration point adjustment	32
6.3. List of calibration points	33
6.4. Autocalibration	35
7. Maintenance	36
7.1. Fuse replacement	36
7.2. External surface cleaning	36
7.3. Firmware update	36
7.4. Error messages	37
8. Specifications	38
8.1. DC voltage	39

8.2.	DC current.....	39
8.3.	Frequency source.....	40
8.4.	Meter.....	40
8.5.	Thermocouples.....	41
8.6.	RTD.....	42
8.7.	Resistance.....	42

Certificate of conformity	44
--	-----------

List of tables

Table 1 Voltage range test 30 V.....	28
Table 2 Voltage ranges verification test.....	29
Table 3 Current range test 25 mA.....	29
Table 4 Current ranges verification test.....	29
Table 5 Frequency verification test.....	30
Table 6 4W Resistance verification test (option).....	30
Table 7 2W Resistance verification test (option).....	30
Table 8 Calibration points – Voltage.....	33
Table 9 Calibration points – Current.....	33
Table 10 Calibration points – Temperature (External RJ).....	33
Table 11 Calibration points – Frequency.....	34
Table 12 Calibration points – Resistance (options).....	34
Table 13 Error code overview	37

List of figures

Figure 1 Front panel.....	6
Figure 2 Input/output terminals.....	7
Figure 3 Display.....	8
Figure 4 Rear panel.....	9
Figure 5 RACK M adapter.....	10
Figure 6 Starting Screen.....	13
Figure 7 Factory default screen.....	13
Figure 8 Function setup.....	14
Figure 9 Main menu.....	16
Figure 10 Preset menu.....	18
Figure 11 Voltage screen.....	19
Figure 12 Current screen.....	20
Figure 13 TC screen.....	21
Figure 14 Frequency screen.....	22
Figure 15 Platinum screen.....	23
Figure 16 Resistance screen.....	24
Figure 17 Step mode.....	24
Figure 18 Step sequence list.....	25
Figure 19 New sequence.....	25
Figure 20 Timing sequence point editing.....	25
Figure 21 Step sequence edit.....	26
Figure 22 Numeric value entry.....	26
Figure 23 Settings menu.....	27
Figure 24 Password entry.....	31

Figure 25 Password entry	31
Figure 26 Calibration point	32
Figure 27 Autocalibration in progress	32
Figure 28 Source Autocalibration	35

1. Introduction

Precision DC calibrator M160 is an accurate source of DC voltage and DC current. It offers thermocouple and RTD simulation and some other features suitable for process calibrations. Calibrator is designed for use in production, but can be used also for development or in calibration laboratories.

Actual set values are displayed on high resolution TFT display. M160 is sophisticated instrument with its own re-calibration procedure. The procedure enables to correct any deviation without any mechanical adjusting.

Instrument is especially suitable for automatic testing procedures. RS232 line (optionally IEEE488, USB and Ethernet bus) is used for connecting calibrator to the computer.

1.1. Front panel overview

Main control segments of the calibrator are:

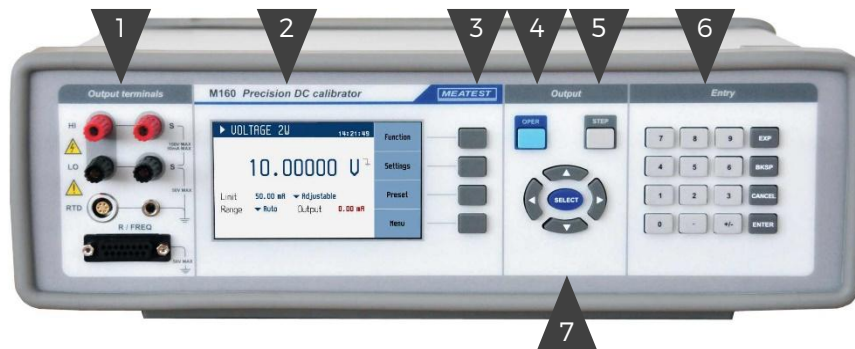

Figure 1 Front panel

1. Output terminals
2. Display
3. Softkeys - four keys next to the display with variable function
4. Oper key connects / disconnects selected value to the output terminals. Connected output terminals are indicated by the lit LED in the key.
5. Step key is used to change functions. Definition of 32 user programmable step sequences. Each sequence contains up to 100 steps (amplitude/duration).
6. Numeric keys
7. Cursor keys

1.1.1. Terminals in detail

All input and output terminals are located on left side of front panel.

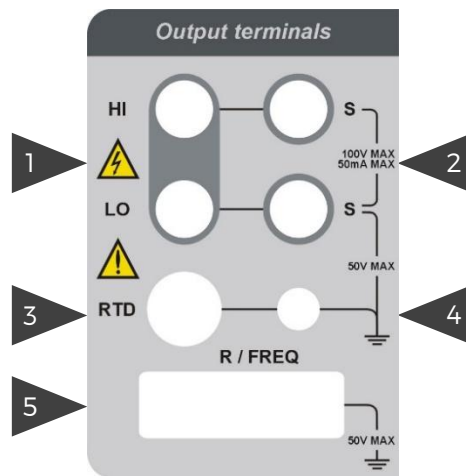

Figure 2 Input/output terminals

1. Voltage/Current terminals - HI / LO are two wire output terminals. LO terminal is floating up to 50Vpk against the case (PE).
2. Voltage sense terminals - S / S are sense terminals for four wire voltage configuration.
3. RTD meter terminal - RTD connector is an input for thermocouple remote sense temperature measurement.
4. GND terminal - Central ground terminal (protective earth) connected to the metal case of the instrument. It is recommended to connect it to the LO voltage terminal if connected meter is not grounded.
5. R/FREQ terminal - Auxiliary connector for RTD (resistance) simulation and frequency generation / measurement.

1.1.2. Display in detail

Display is divided into several sections with following meaning:

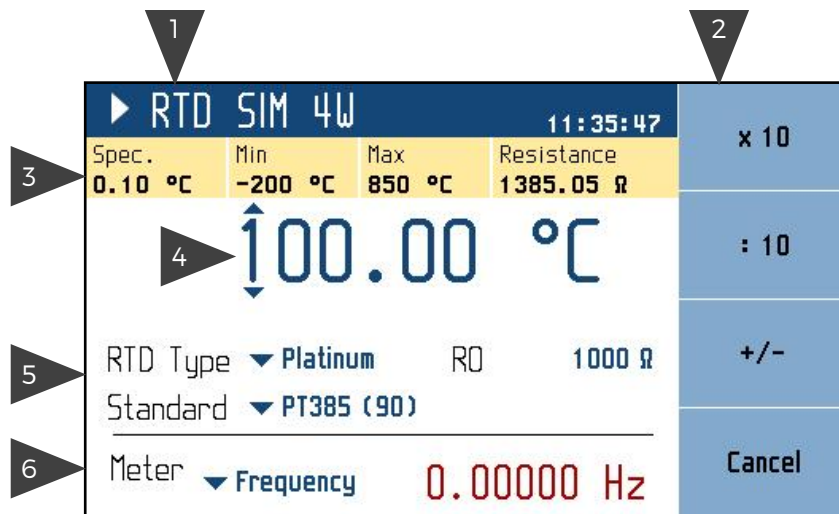

Figure 3 Display

1. Selected function. Symbol on the left indicates system status (■ standby, ◐ settling in, ► running).
2. Softkey labels. Softkeys below the display change their function dynamically based on current workspace, these labels describe Softkey functions at any given time.
3. Tooltip. Shows additional information about selected parameter or main value. Information may include uncertainty, range, description, limits (burden current, compliance voltage), etc. Tooltip is hidden when no parameter is selected.
4. Main value. Can be edited via numerical input, navigation keys.
5. Auxiliary parameters. Every function has different set of auxiliary parameters.
6. This section displays measured frequency or counter value. Meter can be displayed or hidden according to the switch (Meter show) in the Menu.

1.2. Rear panel overview

There is located power line entry module with power line fuse, power line voltage selector 115/230V and power line switch. Interface connectors RS-232 and optionally LAN, USB and IEEE488 on the rear panel.

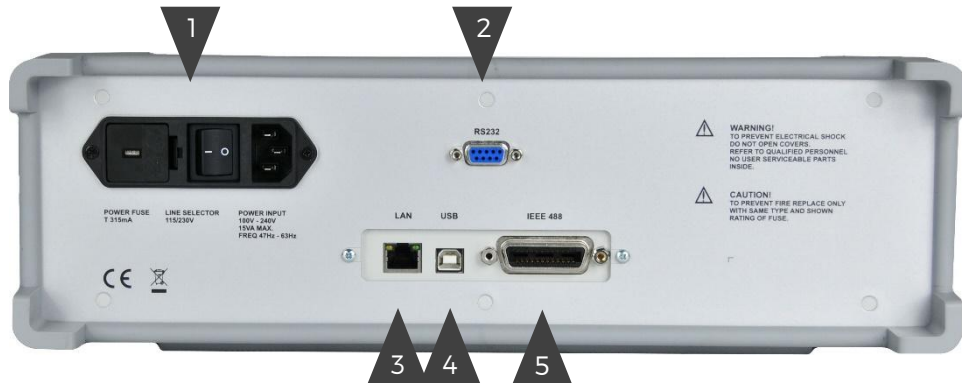

Figure 4 Rear panel

1. Power cord module with power switch, fuse holder and 115/230 V voltage selector
2. RS-232 connector
3. RJ-45 (Ethernet) connector for remote control
4. USB connector for remote control
5. GPIB IEEE-488 connector for remote control

1.3. Options and accessories

Every M160 Precision DC Calibrator delivery includes following items:

- | | |
|--|-------|
| - USB stick with user manual | 1 pc |
| - Factory calibration certificate | 1 pc |
| - Power cord (with European E-type plug, feel free to ask for other types when ordering) | 1 pc |
| - Spare fuse | 2 pcs |
| - Test lead black | 1 pc |
| - Test lead red | 1 pc |
| - Option 160-60 frequency adapter | 1 pc |
| - Option 160-70 resistance adapter (M160 only) | 1 pc |

Following accessory is not part of standard delivery and can be extra ordered:

- Option 91 Pt100 Cold junction compensator
- RACK M adapter (3HE rack adapter is detachable providing extra flexibility)

Calibrator can be ordered with RACK M adapter (3HE). Rack adapter is detachable providing extra flexibility. Module height is 3HE.



Figure 5 RACK M adapter

1.4. Remote control

The calibrator can be integrated into automated calibration systems (ATS) and generally controlled from remote computer via following remote control interfaces:

- RS232
- USB
- GPIB (IEEE488)
- LAN

When controlled remotely, maximum ratings of calibrator's output signals as well as all other specifications are the same as in manual mode.

Meatest software package WinQbase + Caliber is recommended for best automation results. This system is designed for automated and semi automated calibrations of digital and analogue meters including uncertainty calculation, result evaluation and certificate printing according to ISO 17025 standard.

1.4.1. Connection setup

Only one interface can be used for communication at any given time. Default active interface is RS232, other interfaces can be selected in MENU->Interface->Active bus. To establish connection between the calibrator and computer, set interface settings in your computer accordingly:

RS232 and USB connection settings

- COM port see available COM ports in Windows Device Manager
- Baudrate USB according to MENU > Interface > USB Baudrate (9600 by default)
- Baudrate RS232 according to MENU->Interface->RS232 Baudrate (9600 by default)
- Data bits 8
- Stop bits 1
- Parity None
- Handshake (XON/XOFF) Off

GPIB connection settings

- GPIB Address according to MENU->Interface->GPIB Address (2 by default)

LAN connection settings

DHCP service discovery is active by default and is recommended for easiest connection. If you prefer to use fixed IP address or change any other default settings, go to MENU->Interface->LAN Settings.

LAN communication uses Telnet/TCP/UDP protocol. Default log-in for client is “M160_SNxxxxxx 23”, where “xxxxxx” stands for serial number and 23 is default communication port (22 for TCP and UDP protocol).

1.4.2. SCPI commands and protocol

See M160 SCPI manual for complete SCPI reference, more details on communication setup and troubleshooting.

2. Getting started

Inspect package contents when unboxing the calibrator for the first time. See chapter 1.3 for complete list of accessories.

Place the instrument on a level surface before powering on and let it stabilize for at least one hour if the instrument has been stored outside of reference temperatures beforehand.

2.1. Safety precautions

The instrument has been designed according to IEC 61010-1:2011 + A1. Safety is ensured by design and by use of specific components. The manufacturer is not liable for the damage caused by modification of the construction or replacement of parts with non-original ones.

Safety symbols used on the equipment:



Warning, risk of danger.



Warning - risk of electric shock. Hazardous voltage above 50 V DC or AC might be present.



See User Manual.



Protective earth.



Fuse.

To prevent possible electrical shock or personal injury:

- Read carefully safety information before you use the Product.
- Do not alter the Product and use only as specified, or the protection supplied by the Product can be compromised.
- Do not use the Product if it is altered or damaged.
- Use this Product indoors only.
- Use power cord approved for local mains voltage and plug configuration and rated for the Product.
- Keep hands away from all Product terminals and exposed metal cable parts during operation. High voltage on those may be cause death or serious injury.

2.2. Power on and warm-up

The calibrator must be powered by 230/115 V – 50/60 Hz mains. Before connecting the instrument to the mains, check the position of the mains voltage selector located on the rear panel. Set appropriate voltage selector position either 115 V or 230 V.

Plug one end of the power cord into connector on the rear panel and connect the other end of the power cord into a wall outlet. Turn the calibrator on with mains switch right next to it. You should see following splash screen on display.

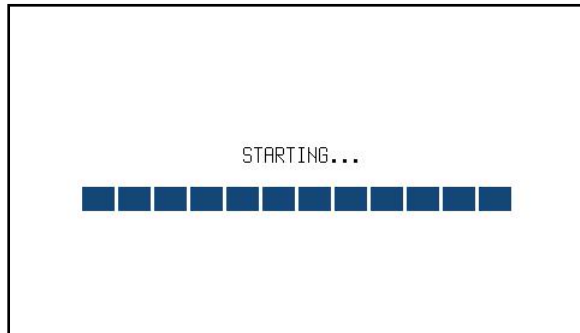

Figure 6 Starting Screen

Calibrator then performs internal hardware checks for app. 5 seconds and then starts in Startup state (called Preset). Startup preset can be customized and up to 99 other presets can be defined and recalled later at any time. By default the Startup preset is set to VDC function, 10 V with output switched off.

Warm-up

Specified parameters are guaranteed 30 minutes after switching the calibrator on and stabilizing it in reference conditions.



Figure 7 Factory default screen

2.3. Function setup

Function can be changed after pressing „Function“ softkey. New function is selected using cursor keys ▲, ▼ or display softkeys. Selection must be confirmed by pressing SELECT key, ENTER key or „OK“ softkey.

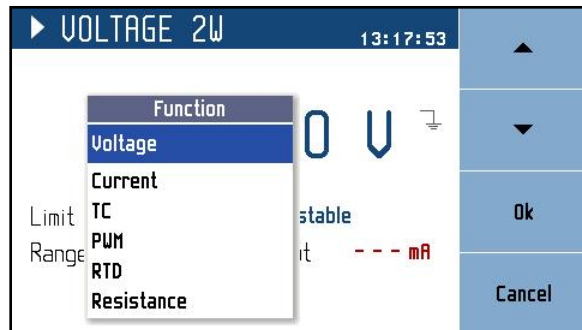

Figure 8 Function setup

2.4. Signal output

Calibrator output can be turned on by pushing OPER button. Pressing OPER button again turns output off. Output turns off automatically on calibrator startup and function switch. Output state is indicated by LED light in OPER button.

2.5. What to do in case of failure

If an obvious failure occurs during the operation (e.g. the display is not lit, the fan is not turning), the calibrator must be switched off immediately. First, check the fuse located in the power cord receptacle. Procedure is following:

- Remove the end of power cord from the mains connector at the rear panel.
- Insert the blade of a flat screwdriver into the opening cut in the mains voltage selector and pry out the fuse holder.
- Remove the fuse. Replace it with new fuse of the same rating if the fuse was broken.
- Replace the fuse holder, reconnect the power cord and switch on the calibrator. If the problem persists, contact the manufacturer.

If an obvious fault is evidenced, e.g. a measurement range or an operating mode is not functional, the user cannot correct the fault. Contact the manufacturer.

Hidden faults can cause different symptoms and be caused by different causes. Usually, they cause instability of some parameter. Hidden defects can be caused by unacceptable distortion, degraded insulation etc. In this case contact the manufacturer.

Sometimes it seems that the calibrator has hidden defect, when the rules for correct operation are not adhered to. In this case, the fault is caused by the operator. Most frequent cases of false “hidden defects”:

- mains voltage out of tolerance limits or unstable
- wrong grounding of the measurement circuit (bad connection of the ground terminal of the mains outlet, or several ground connections when grounding loops are formed)
- proximity to sources of intensive influence, whose products are spread through the mains or propagated by the electromagnetic field
- strong electrostatic or electromagnetic field which can cause major instability during calibration using higher impedance.

3. Menu reference

Main menu is displayed after pressing „Menu“ softkey. Main Menu allows configuration and calibration of the device. Four buttons on the front panel give access to main menu sections:

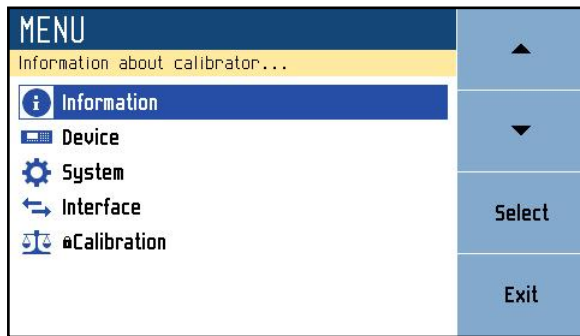

Figure 9 Main menu

Main menu is the most comprehensive setup tool of the calibrator, containing information like serial number, calibration date or display brightness as well as remote control interface setup or calibration constants.

Short tooltip in yellow box shows basic description of selected item. Main menu items are described in detail in chapters 3.1 – 3.5.

3.1. Information menu

Information menu contains general device data which cannot be modified by the user:

<ul style="list-style-type: none"> - Manufacturer - Model - Serial number 	Device identification
<ul style="list-style-type: none"> - Software version 	Device configuration
<ul style="list-style-type: none"> - Expiration of Calibration validity 	Device readiness info. Calibration expiration date is equal to last calibration date plus calibration interval, see menu item Calibration for more details.

3.2. Device menu

Device menu is divided according to calibrator functions that gives access to additional function related settings, master limits and unlock code function. Unlock code function will allow you to enable, disable or set some calibrator properties after entering a password.

Master limits is protected with calibration password and it serves as user limitation of maximum voltage and current values during normal operation of device in manual and remote control to limit user error. It helps protect Calibrator against user error. Values set here are subsequently taken as the maximum settable values for any calibrator function. User is informed that limitation is from this functionality when trying to exceed them.

3.3. System menu

System menu contains general, user-accessible device settings:

- Language Language version of user interface
- Display backlight [0 – 100 %]
- Button light intensity [0 – 100 %]
- Beeper volume [0 – 100 %]
- Show tooltips on display Turns yellow menu tooltip On/Off
- Date & Time Password protected submenu with following items
 - o Time System time in HH:MM:SS format
 - o Date System date in selected format
 - o Format Date format [M/D/Y, M-D-Y, D/M/Y, D.M.Y, D-M-Y, Y/M/D, Y.M.D]
 - o Show date & time on display [On/Off]

3.4. Interface menu

Interface menu contains remote control connection settings:

Menu item	Range / format	Default value
Active bus	RS232/GPIB/USB/LAN	RS232
RS232 Baudrate	1200 – 115200	9600
GPIB Address	0 – 31	2
USB Baudrate	1200 – 115200	9600
LAN Settings		
> DHCP	On/Off	On
> IP Address	IPv4 format; locked with DHCP On	192.168.001.100
> Subnet mask	IPv4 format; locked with DHCP On	255.255.255.000
> Default gateway	IPv4 format; locked with DHCP On	255.255.255.255
> Telnet port number	0 – 9999	23
> TCP port number	0 – 9999	22
> UDP port number	0 – 9999	22
> Host name	14 alphanumeric characters; locked with DHCP Off	M160_SN750011
> Assigned IP address	IPv4 format; current IP address of the device	

3.5. Calibration menu

Calibration menu contains internal calibration constants and other tools for device adjustment and is therefore password protected. See chapter 6 for more details on M160 adjustment. Calibration menu has following items:

1. Data. Contains current calibration data. Structure of this menu is described in chapter 6.1.
2. Backup. Calibration data backup. See below for more details.
3. Password. Changes calibration password. Calibration password gives access to Calibration menu and Date/Time settings in Information menu.
4. Calibration date. Calibration date is updated automatically upon calibration data adjustment or just by manual confirmation (if calibration doesn't require adjustment).
5. Calibration interval. Recommended interval is 12 months.

Backup function allows you to save and recall entire sets of calibration data. Calibration data are also saved automatically when any calibration value gets changed, creating a record with “Auto” storage (or overwriting an existing one if the last change occurred within last 90 days). Use softkeys to save and recall previously stored calibration data sets:

1. Back up. Saves currently used calibration data, overwriting existing record on selected Location. Only empty records and records with Calibration access and Manual storage can be overwritten.
2. Try. Loads selected record temporarily, original calibration data will be restored on next calibrator startup.
3. Load. Loads selected record permanently.
4. Delete. Deletes record. Only records with Calibration access and Manual storage can be deleted.

3.6. Preset menu

Preset menu is displayed after pressing „Preset“ softkey in the main function window. It won't appear in editing mode so when in editing mode you have to press “Cancel” first.

PRESETS			Save
Preset	Function	Date	
00 Startup	Resistance	01.01.2012	Load
01 ---	---	---	
02 ---	---	---	Clear
03 ---	---	---	
04 ---	---	---	Exit
05 ---	---	---	
06 ---	---	---	
07 ---	---	---	

Figure 10 Preset menu

Presets contain all settings that normally disappear on restart. This includes auxiliary and main parameters for all functions (see previous chapter), selected function, main value and step state. Presets doesn't contain system, interface or calibration data as well as output state and step tables. Up to 100 presets can be stored including a special “Startup” preset which is loaded on every device startup.

Startup (position 00) is reserved for the definition of device settings after power on. User can save any required Startup configuration.

Preset can be selected using cursor keys where ◀, ▶ skip through pages.

Save – Save current device settings to selected preset. Preset name can be edited before final saving.

Load – Load selected preset and return to function window defined by the preset.

Clear – Set selected preset to default factory setup.

Exit – Return to main function window.

4. Calibration examples

4.1. Voltage

Offers direct setting of DC voltage.



Figure 11 Voltage screen

Parameters:

Limit:	1.00 mA - 50.00 mA Maximum output current without limiting the output voltage. Parameter can be changed in the switch position “Adjustable”. In the switch position “Maximum” is set to maximum value. When this value is exceeded on device terminals, terminal overload indicator lights up:  .
Range:	Auto, 100V, 30V, 3V, 300mV Voltage range selection.
Output:	Output current measured value.

Auxiliary parameters (Settings):

Terminal sense:	Internal (2W), External (4W) Two or four wire output configuration.
Terminal ground:	On, Off Connects LO terminal with the protective earth (PE) terminal in On state. On state is indicated by the GND  symbol next to the main value.
Steps:	Definition of 32 user programmable step sequences. Each sequence contains up to 100 steps (amplitude/duration).

4.2. Current

Offers direct setting of DC current.



Figure 12 Current screen

Parameters:

- Limit:** 1.00 V - 100.00 V
Maximum output voltage without limiting the output current.
Parameter can be changed in the switch position “Adjustable”.
In the switch position “Maximum” is set to maximum value. When this value is exceeded on device terminals, terminal overload indicator lights up: .
- Range:** Auto, 50mA, 25mA
Current range selection.
- Output:** Output voltage measured value.

Auxiliary parameters (Settings):

- Terminal ground:** On, Off
Connects LO terminal with the protective earth (PE) terminal in On state.
On state is indicated by the GND  symbol next to the main value.
- Steps:** Definition of 32 user programmable step sequencies.
Each sequence contains up to 100 steps (amplitude/duration).

4.3. TC

Offers direct setting of TC temperature.



Figure 13 TC screen

Parameters:

TC type:	R, S, B, J, T, E, K, N, M, C, D, G2
RJ mode:	Manual, Extern Reference junction compensation.
RJ:	Reference junction temperature. Red measured value for Extern RJ mode. Blue editable value for Manual RJ mode.
Limit:	When 50mA or the Master limit value is exceeded on device terminals, terminal overload indicator lights up: ■ .

Auxiliary parameters (Settings):

Terminal ground:	On, Off Connects LO terminal with the protective earth (PE) terminal in on state. On state is indicated by the GND  symbol next to the main value.
Temperature unit:	°C, °F, K
External RJ:	Folder with all RJ settings.
RJ type:	Platinum, Nickel – type of external RTD.
RJ R0:	100 Ω - 200 Ω, R0 value of external RTD.
Platinum standard:	Pt385 (68), Pt385 (90), Pt3916, Pt3926, Pt user
Platinum user coeff. A:	
Platinum user coeff. B:	
Platinum user coeff. C:	User coefficients for Pt user platinum standard.
Steps:	Definition of 32 user programmable step sequences. Each sequence contains up to 100 steps (amplitude/duration).

4.4. Frequency

Offers direct setting of frequency (period) of generated pulses.



Figure 14 Frequency screen

Parameters:

Duty:	0.50% - 99.50%, duty cycle of generated signal
Count:	0 - 9999999, number of generated pulses Pulses generator must be set to On in Settings.
Pull-Up:	Off, On
Actual:	Actual number of generated pulses

Auxiliary parameters (Settings):

Expression:	Frequency, Period
Pulses generator:	Off, On Exact number of pulses generation.
Steps:	Definition of 32 user programmable step sequences. Each sequence contains up to 100 steps (amplitude/duration).

4.5. RTD

Offers direct setting of temperature of simulated resistance thermometer.



Figure 15 Platinum screen

Parameters:

RTD Type:	Platinum, Nickel
Standard:	PT385 (68), PT385 (90), PT3916, PT3926, PT User
R0:	100 Ω - 1000 Ω

Auxiliary parameters (Settings):

Wire connection:	2W, 4W Two or four wire output configuration.
Terminal ground:	On, Off Connects Li and Lu terminals with the protective earth (PE) terminal in On state. On state is indicated by the  GND symbol next to the main value.
Temperature unit:	$^{\circ}\text{C}$, $^{\circ}\text{F}$, K
Platinum user coeff. A:	
Platinum user coeff. B:	
Platinum user coeff. C:	User coefficients for Pt user platinum standard.
Steps:	Definition of 32 user programmable step sequences. Each sequence contains up to 100 steps (amplitude/duration).

4.6. Resistance

Offers direct setting of Resistance.



Figure 16 Resistance screen

Parameters:

Short: Off, On
Short circuit simulation. Also the short circuit must be connected to the output terminals by the OPER key.

Auxiliary parameters (Settings):

Wire connection: 2W, 4W
Two or four wire output configuration.

Terminal ground: On, Off
Connects Li and Lu terminals with the protective earth (PE) terminal in On state. On state is indicated by the GND symbol \perp next to the main value.

Steps: Definition of 32 user programmable step sequences.
Each sequence contains up to 100 steps (amplitude/duration).

4.7. Setting the step mode

Function can be changed after pressing „Step“ key.



Figure 17 Step mode

New parameters:

Step – table defined by the user

Count – number of repetitions (N/A for resistance and RTD); set 0 for infinite loop

Sequence is defined by table of time intervals and corresponding function values, all of which can be edited. Maximum number of tables is 64 with each table having up to 100 time intervals. Sequence is started by pressing OPER button or sending OUTP ON command via remote control. Manual table setup can be done in *Settings* → *Steps*:

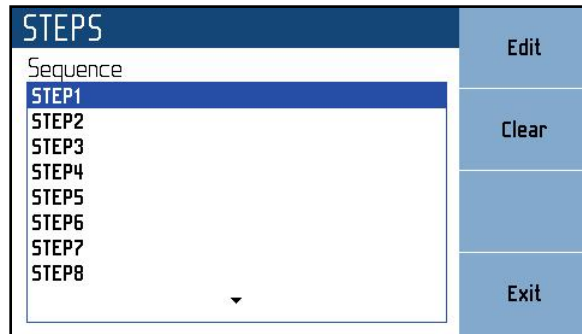

Figure 18 Step sequence list

Menu shows a list of all sequences. Softkeys on the right side of the panel have these functions:

Edit – edit selected sequence. Sequence can be selected using cursor keys where ◀, ▶ skip through pages.

Clear – clear all sequence data and set it to default (plain) state. Message prompt will appear before final clearance of the sequence.

Exit – close the sequence list and return previous menu.

Creating a new table - Pressing the *Edit* softkey upon plain sequence opens this submenu:

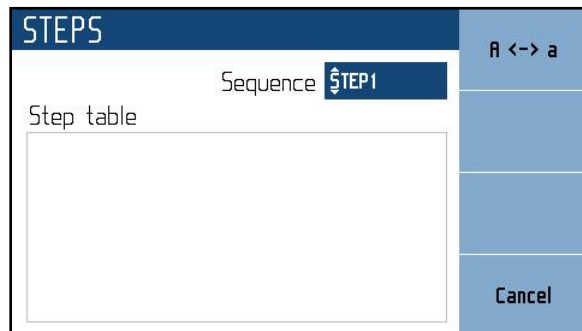

Figure 19 New sequence

Step table – table name is set using ▲, ▼ (character selection) and ◀, ▶ (position) cursor keys. Name may be 8 characters long at most. Softkey „A <-> a“ switches between uppercase and lowercase of selected character. Table name has to be set before proceeding to the next step using **SELECT** key.

Step table – a list of values and their durations in seconds. Browsing through the table is done by ▲, ▼ cursor keys. Editing is done using these softkeys:

Add – create a new point.



Figure 20 Timing sequence point editing

Duration – duration of selected resistance (from 10 ms to 600 s). Press the **SELECT** key to proceed.

Amplitude – corresponding function value. Range is selected automatically to fit all values in sequence.

Edit – show the “Timing edit” panel for selected point to allow editing.

Delete – delete selected point.

Cancel – deactivate the Lookup Table and allow for curve saving.

Save – closes the table and saves current settings.

Cancel – closes the table and does not save current settings.

Editing an existing table

Existing table can be edited in the same way as it can be created. Editable entries (Sequence name, Timing table points) are selected using the **SELECT** key.

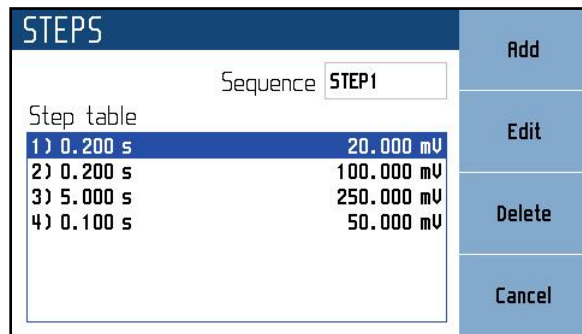

Figure 21 Step sequence edit

4.8. Setting the value of output signal

Edit mode

Parameters of output signal can be changed in Edit mode. Only parameters displayed in blue color can be changed. Display can be switched to edit mode in different ways:

- Pressing numeric button
- Pressing **SELECT** key
- Pressing cursor button

In edit mode is edited value highlighted by blue background. Exception is the main parameter, which is not highlighted. You can change among editable (blue) parameters pressing the **SELECT** key. Edit mode is finished by pressing CANCEL key.

Entry of the value using numeric keyboard

Use the numeric keyboard to set the desired value. After the first digit is entered, input box is displayed. In the upper row of the input box is the name of edited parameter. Using softkeys you can enter the new value in different units.



Figure 22 Numeric value entry

- Enter desired value.

- After the entry is complete press softkey with requested unit or press ENTER key. ENTER key inputs the value in basic units (V, Ω , °C ...).
- Instrument sets the new value.
- The value is copied to the appropriate field in the screen and the input box disappears.

Note: All parameters have limits (high and low). If the entered value is outside these limits warning message is displayed „Value too high (low)“ and new value is not accepted.

Entry of the value using cursor keys

- Press ◀, ▶, ▲ or ▼ key. The display now includes cursor marks which points to the active digit.
- ▲, ▼ keys can be used to change the value. ◀, ▶ keys can be used to change the position of active digit.
- To get to the default screen, press CANCEL key.

4.9. Auxiliary parameter settings (Settings menu)

Settings menu is displayed after pressing „Settings“ softkey in main function window. It won't appear in editing mode so when in editing mode you have to press “Cancel” first.

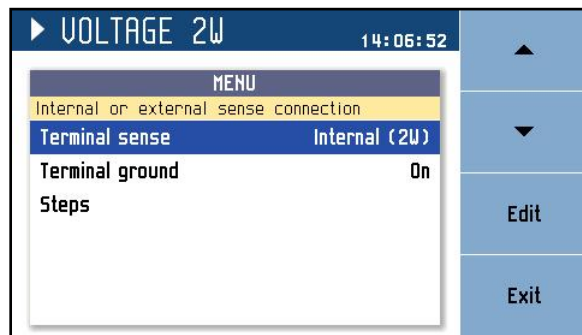

Figure 23 Settings menu

In settings menu you can edit all available auxiliary parameters of the current function. These settings are discarded on restart so if you'd like to save them for your next calibration session, use the “Preset” feature.

5. Performance verification

Specifications of this calibrator are defined for 1 year period so it should be periodically tested (and adjusted if necessary) within the same period of time. If you don't have the necessary equipment or can't do the calibration on your own, please ask local Meatest representative to help you calibrate this device.

5.1. Required equipment

Following instruments are required for performance verification test:

- Keysight 3458A, Fluke 8508A or similar 8½ DMM with 10 ppm accuracy in DC voltage or better
- Keysight 53181A, Keysight 53131A or similar counter with 10 ppm accuracy or better

5.2. Verification procedure

Make sure the calibrator has been turned on in reference temperature conditions at least 1 hour before performing verification test. Verification procedure has following parts:

- 30 V voltage range test with linearity check
- Voltage internal ranges 300 mV, 3 V, 100 V
- 25 mA current range test with linearity check
- Current internal range 50 mA
- Frequency test at 1 kHz
- 4W resistance test in points 10 Ω, 100 Ω, 1 kΩ, 10 kΩ, 100 kΩ, 300 kΩ (with RTD option)
- 2W resistance test in points 50 Ω, 100 Ω (with RTD option)

Recommended testing points are the same as the points in table of allowed limits (see tables below).

5.2.1. 30 V voltage range test with linearity test

Range	Value	Max deviation
30 V	6 V	190 μV
30 V	12 V	280 μV
30 V	18 V	370 μV
30 V	24 V	460 μV
30 V	30 V	550 μV
30 V	-6 V	190 μV
30 V	-12 V	280 μV
30 V	-18 V	370 μV
30 V	-24 V	460 μV
30 V	-30 V	550 μV

Table 1 Voltage range test 30 V

5.2.2. Voltage ranges verification test

Range	Value	Max deviation
300 mV	150 mV	4.75 μ V
300 mV	300 mV	7 μ V
300 mV	-150 mV	4.75 μ V
300 mV	-300 mV	7 μ V
3 V	1.5 V	32.5 μ V
3 V	3 V	55 μ V
3 V	-1.5 V	32.5 μ V
3 V	-3 V	55 μ V
100 V	50 V	1.25 mV
100 V	100 V	2 mV
100 V	-50 V	1.25 mV
100 V	-100 V	2 mV

Table 2 Voltage ranges verification test

5.2.3. 25 mA current range test with linearity test

Range	Value	Max deviation
25 mA	5 mA	1.18 μ A
25 mA	10 mA	1.35 μ A
25 mA	15 mA	1.53 μ A
25 mA	20 mA	1.70 μ A
25 mA	25 mA	1.88 μ A
25 mA	-5 mA	1.18 μ A
25 mA	-10 mA	1.35 μ A
25 mA	-15 mA	1.53 μ A
25 mA	-20 mA	1.70 μ A
25 mA	-25 mA	1.88 μ A

Table 3 Current range test 25 mA

5.2.4. Current ranges verification test

Range	Value	Max deviation
50 mA	30 mA	2.05 μ A
50 mA	50 mA	2.75 μ A
50 mA	-30 mA	2.05 μ A
50 mA	-50 mA	2.75 μ A

Table 4 Current ranges verification test

5.2.5. Frequency

Range	Value	Max deviation
15 kHz	1 kHz	0.05 Hz

Table 5 Frequency verification test

5.2.6. Resistance 4W (option)

Range	Value	Max deviation
200 Ω	50 Ω	40 m Ω
200 Ω	100 Ω	65 m Ω
200 Ω	150 Ω	90 m Ω
1000 Ω	300 Ω	60 m Ω
1000 Ω	1000 Ω	200 m Ω
3000 Ω	3000 Ω	600 m Ω
10000 Ω	10000 Ω	2 Ω
30 k Ω	30 k Ω	15 Ω
100 k Ω	100 k Ω	100 Ω
300 k Ω	300 k Ω	1.5 k Ω

Table 6 4W Resistance verification test (option)

5.2.7. Resistance 2W (option)

Range	Value	Max deviation
200 Ω	50 Ω	50 m Ω
200 Ω	100 Ω	75 m Ω

Table 7 2W Resistance verification test (option)

6. Adjustment

Access to the calibration mode is from the setup Menu.

Correct password must be entered before calibration. Without correct password the access to the calibration mode is refused. Default factory set calibration code is “2”. Return to standard mode is possible after pushing the CANCEL key.

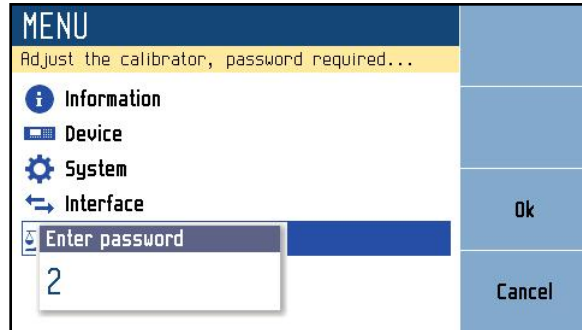

Figure 24 Password entry

Warning: Calibration data cannot be changed during warm-up period. You can still browse previously saved data but all changes will be discarded.

6.1. Calibration menu structure

Calibration menu appears after entering the correct password.

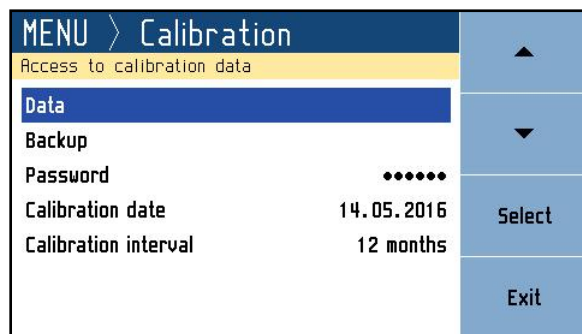

Figure 25 Password entry

Data - Direct access to all calibration data.

Backup - Backup is a tool for managing calibration backups. For example it allows recovery of older calibration data.

Password - Calibration Password editing.

Calibration date - Last calibration date.

Calibration interval - Recommended calibration interval for this unit.

6.2. Calibration point adjustment

Following instruments are required for full adjustment:

- Keysight 3458A, Fluke 8508A or similar 8½ DMM with 10 ppm accuracy in DC voltage or better
- Keysight 53181A, Keysight 53131A or similar counter with 10 ppm accuracy or better

Go to “Calibration->Data” and using softkeys, select function and then range to be adjusted. All data points shall be adjusted in shown order in one go, see chapter “Adjustment points” for more details. Having selected the required calibration range, the following page is shown:

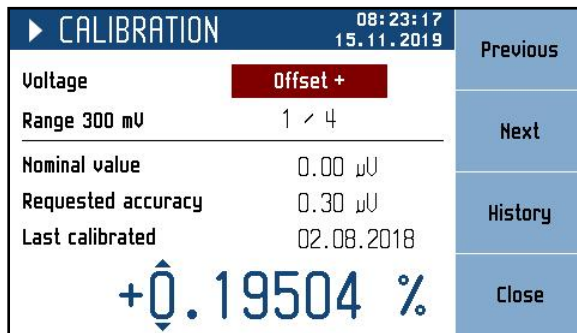

Figure 26 Calibration point

Here you can navigate through data points of selected range (300 mV in this case) using Previous and Next softkeys, check previous values of this data point with History softkey or change its value using cursor keys.

To adjust selected data point, connect standard device to output terminals and select its function accordingly (8½ digit DMM, Vdc function). Turn output on with OPER key. Adjust offset value with cursor keys so that nominal value and standard device readout are as close as possible.

Example: Let’s say you selected the data point 1 (offset+) in 300 mV range as shown above. You turned output on and your standard multimeter reads 0.83 μV. Now you have to gradually decrease the offset value until the standard meter reads voltage around 0.00 μV. The closer you get, the better.

Once done, confirm the new value with Save softkey (output has to be switched on) and continue with next data point or leave the calibration menu with Close softkey.

Important note: With autocalibration enabled, changing 300 mV Offset+ data point will trigger a short sequence of internal measurements, showing this message:

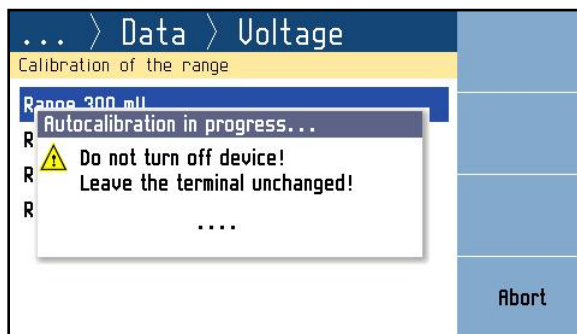

Figure 27 Autocalibration in progress

Do not interrupt this operation! All autocalibration offsets depend on this data point, aborting this measurement will invalidate all autocalibration offsets. The measurement can be re-initiated by adjusting the 300 mV Offset+ data point again.

6.3. List of calibration points

The following is a list of all functions and their adjustment points. The instrument can be partially adjusted as well but in order to achieve best overall accuracy you should adjust all points in one go and in the same order as listed below.

6.3.1. Voltage

Range	Point	Nominal value	Requested Accuracy
300 mV	Offset +	0.00 μ V	0.3 μ V
300 mV	Offset -	0.00 μ V	0.3 μ V
300 mV	Full range +	285 mV	1.2 μ V
300 mV	Full range -	-285 mV	1.2 μ V
3 V	Offset +	0.00 μ V	2 μ V
3 V	Offset -	0.00 μ V	2 μ V
3 V	Full range +	2.85 V	11 μ V
3 V	Full range -	-2.85 V	11 μ V
30 V	Offset +	0.00 μ V	20 μ V
30 V	Offset -	0.00 μ V	20 μ V
30 V	Full range +	28.5 V	110 μ V
30 V	Full range -	-28.5 V	110 μ V
100 V	Offset +	0.00 μ V	100 μ V
100 V	Offset -	0.00 μ V	100 μ V
100 V	Full range +	95 V	400 μ V
100 V	Full range -	-95 V	400 μ V

Table 8 Calibration points - Voltage

6.3.2. Current

Range	Point	Nominal value	Requested Accuracy
25 mA	Offset +	0.00 μ A	0.1 μ A
25 mA	Offset -	0.00 μ A	0.1 μ A
25 mA	Full range +	23.75 mA	0.22 μ A
25 mA	Full range -	-23.75 mA	0.22 μ A
50 mA	Offset +	0.00 μ A	0.1 μ A
50 mA	Offset -	0.00 μ A	0.1 μ A
50 mA	Full range +	47.5 mA	0.34 μ A
50 mA	Full range -	-47.5 mA	0.34 μ A

Table 9 Calibration points - Current

6.3.3. Temperature (External RJ)

Range	Point	Nominal value	Requested Accuracy
-	Offset	23 °C	0.01 °C

Table 10 Calibration points - Temperature (External RJ)

6.3.4. Frequency

Range	Point	Nominal value	Requested Accuracy
15 kHz	100 Hz	100 Hz	500 μ Hz

Table 11 Calibration points – Frequency

6.3.5. Resistance (option)

Range	Point	Nominal value	Requested Accuracy
-	1	30 m Ω	1 m Ω
-	2	19.4 Ω	1 m Ω
-	3	38.2 Ω	1 m Ω
-	4	76.8 Ω	2 m Ω
-	5	150 Ω	3 m Ω
-	6	299 Ω	6 m Ω
-	7	589 Ω	15 m Ω
-	8	1.15 k Ω	30 m Ω
-	9	2.19 k Ω	100 m Ω
-	10	4.37 k Ω	250 m Ω
-	11	8.59 k Ω	500 m Ω
-	12	16.7 k Ω	1 Ω
-	13	33.0 k Ω	5 Ω
-	14	65.0 k Ω	10 Ω
-	15	129 k Ω	20 Ω
-	16	253 k Ω	40 Ω
-	17	503 k Ω	80 Ω
-	18	1.00 M Ω	200 Ω
-	19	2.00 M Ω	400 Ω
-	20	3.92 M Ω	1 k Ω
-	21	7.82 M Ω	5 k Ω
-	22	15.5 M Ω	50 k Ω
-	23	29.8 M Ω	200 k Ω
-	24	58.8 M Ω	500 k Ω
-	25	117 M Ω	1 M Ω
-	2W short	382 m Ω	1 m Ω

Table 12 Calibration points – Resistance (options)

6.3.6. Cold junction compensator calibration

For calibration of cold junction compensator look up: [AN108 Option 91 Verification and Calibration manual](#).

6.4. Autocalibration

Autocalibration offsets are based on internal measurements of output terminals. This is to compensate for small daily drifts caused by material or temperature changes. Zero offsets can be measured in “Calibration->Data->Advanced->Source Autocalibration”, 4W connection offset against 2W can be set in “Calibration->Data->Advanced->Source voltage terminal sense”.

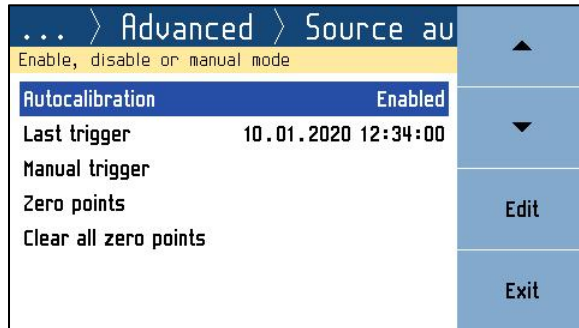



Figure 28 Source Autocalibration

For best results, all test leads shall be disconnected before triggering an autocalibration. If the calibrator cannot be disconnected (eg. as part of automated test system), make sure there is no active load at least. There are 3 autocalibration modes:

- Enabled. Autocalibration is triggered automatically every 24 hours. Measured offsets are added to output values.
- Manual. Autocalibration can be triggered on demand (via keyboard or interface). Measured offsets are added to output values.
- Disabled. Measured offsets are not used. 24-hour stability applies in this mode only.

Running autocalibration is indicated by  icon and can be interrupted by turning output on. Interrupted autocalibration will be resumed automatically when the calibrator is left idle again. Autocalibration will not start unless calibration conditions (minimum warm-up time, reference temperature,...) are met.

Last measured zero offsets can be found in “Zero points”.

7. Maintenance

This chapter explains how to perform the routine maintenance to keep your device in optimal operating conditions.

7.1. Fuse replacement

M160 calibrator has user-replaceable fuse, located on rear panel. Replace the fuse as follows:

1. Switch the calibrator off and disconnect power cord from it
2. Remove the end of power cord from the mains connector at the rear panel.
3. Insert the blade of a flat screwdriver into the opening cut in the mains voltage selector and pull out the fuse holder.
4. Remove the fuse, check if it's blown and replace it with new fuse of the same rating if needed.

7.2. External surface cleaning

To keep the device in mint condition, clean the case and front panel keys using a soft cloth slightly dampened with either water or a non-abrasive mild cleaning solution that is not harmful to plastics.

7.3. Firmware update

Internal firmware can be updated by user. It is recommended check for firmware updates every 6 months or so to get the latest UI improvements, new features and bug fixes. To do this:

1. Go to www.meatest.com/drivers-updates and find firmware update file (.upl) for your device. If your device is not listed, contact Meatest support and ask for firmware update file for your device.
2. Check if the update file version is greater than yours, installed FW version can be found in MENU > Information > Software version. If the installed version is the same, stop the update process.
3. Download Uploader program from the same website and install it if you haven't already.
4. Connect the instrument to your PC using RS232 cable and use Uploader to update your instrument's firmware. The calibrator will be restarted once the update is finished.
5. Check installed FW version.

7.4. Error messages

The following table lists an overview of error codes that you might come across.

Error	Message
-100	"Command error"
-101	"Invalid character"
-102	"Syntax error"
-103	"Invalid separator"
-104	"Data type error"
-105	"GET not allowed"
-108	"Parameter not allowed"
-109	"Missing parameter"
-112	"Program mnemonic too long"
-113	"Undefined header"
-114	"Header suffix out of range"
-120	"Numeric data error"
-121	"Invalid character in number"
-130	"Suffix error"
-141	"Invalid character data"
-144	"Character data too long"
-151	"Invalid string data"
-161	"Invalid block data"
-203	"Command protected"
-220	"Parameter error"
-222	"Data out of range"
-283	"Illegal variable name"
-350	"Queue overflow"
-400	"Query error"
-410	"Query INTERRUPTED"
-420	"Query UNTERMINATED"
-430	"Query DEADLOCKED"
-440	"Query UNTERMINATED after indefinite response"
514	"Command not allowed with GPIB"

Table 13 Error code overview

8. Specifications

Uncertainties include long-term stability, temperature coefficient, linearity, line regulation and the traceability of factory and National calibration standards. Specified accuracy is valid after 30-minute warm up in temperature range $23^{\circ}\text{C} \pm 10^{\circ}\text{C}$. Specified accuracy is one year accuracy.

Ambient conditions

Reference conditions:	+13 °C - +33 °C (Voltage, Current, TC, Frequency) +20 °C - +26 °C (RTD, Resistance)
Operating conditions:	+5 °C - +45 °C
Storage conditions:	-10 °C - +55 °C
Temperature coefficient:	<1ppm/°C (frequency in+out) <10ppm/°C (RTD in; for TC compensation) <25ppm/°C (resistance, RTD out) 10 % of specification /°C (voltage, current, TC out)

General

Warm-up time:	30 minutes
Power supply:	115/230 V (- 13 %, + 10 %), 47-63 Hz, 60 VA max.
Dimensions:	W 390 mm, H 128 mm, D 310 mm
Weight:	5.5 kg
Protection fuses:	T315mAL250 for 230 V T630mAL250 for 115 V

8.1. DC voltage

Summary range:	0 to 100 Vdc
Voltage resolution:	6½ digits
Typical linearity:	2 ppm
4W sense compensation limit	0.2 V

Ranges, resolution and uncertainty ±[ppm of value + absolute offset]

Range	Autocal. on	Autocalibration off			
	1 year	24h stability ¹⁾	90 days	180 days	1 year
300.0000 mV	15 + 2.5 µV	3 + 1.5 µV	15 + 2.5 µV	18 + 3 µV	20 + 3 µV
3.000000 V	15 + 10 µV	3 + 5 µV	15 + 10 µV	18 + 15 µV	20 + 20 µV
30.00000 V	15 + 100 µV	3 + 50 µV	15 + 100 µV	18 + 150 µV	20 + 200 µV
100.0000 V	15 + 500 µV	3 + 200 µV	15 + 500 µV	18 + 750 µV	20 + 1 mV

1. 24 hour stability applies at a constant temperature (± 1°C)

Distortion and Load Characteristics

Range	Max. current	Typical noise		Typ. output resist.		CMRR
		0.1 – 10 Hz	10 Hz – 100 kHz	2W	4W	50/60 Hz
300.0000 mV	50 mA	2 µV _{PP}	150 µV _{PP} / 25 µV _{RMS}	< 2 mΩ	< 0.1 mΩ	>120 dB
3.000000 V	50 mA	2 µV _{PP}	150 µV _{PP} / 25 µV _{RMS}	< 2 mΩ	< 0.1 mΩ	>120 dB
30.00000 V	50 mA	20 µV _{PP}	400 µV _{PP} / 50 µV _{RMS}	< 2 mΩ	< 0.3 mΩ	>130 dB
100.0000 V	25 mA	40 µV _{PP}	600 µV _{PP} / 80 µV _{RMS}	< 2 mΩ	< 0.5 mΩ	>130 dB

8.2. DC current

Summary range:	0 to 50 mAdc
Current resolution:	6 digits
Typical linearity:	15 ppm

Ranges, resolution and uncertainty ±[ppm of value + absolute offset]

Range	Autocal. on	Autocalibration off		
	1 year	90 days	180 days	1 year
25.0000 mA	35 + 1 µA	35 + 2 µA	40 + 2.5 µA	45 + 3 µA
50.0000 mA	35 + 1 µA	35 + 2 µA	40 + 2.5 µA	45 + 3 µA

Distortion and Load Characteristics

Range	Max. voltage	Typical noise		Typical 2W output resistance	CMRR
		0.1 – 10 Hz	10 Hz – 100 kHz		50/60 Hz
25.0000 mA	100 V	0.3 µA _{PP}	10 µA _{PP} / 2 µA _{RMS}	> 300 MΩ	>50 nA/V
50.0000 mA	30 V	0.3 µA _{PP}	10 µA _{PP} / 2 µA _{RMS}	> 300 MΩ	>50 nA/V

8.3. Frequency source

Summary range: 10 mHz to 15 kHz
Open collector: max. 30 V/50 mA
or internal pull up 100R to +5V ($\pm 10\%$)

Ranges, resolution, 1 year uncertainty \pm [ppm of value]

Range	Uncertainty
200.0000 mHz	50
2000.000 mHz	50
20.00000 Hz	50
200.0000 Hz	50
2000.00 Hz	50
4.0000 kHz	100
10.000 kHz	600
15.00 kHz	1500

8.4. Meter

Frequency meter

Summary range: 10 mHz to 100 kHz
Frequency resolution: $5\frac{1}{2}$ digits
Accuracy: ± 50 ppm

Current meter (in voltage function)

Ranges: 5 mA, 25 mA, 50 mA (based on current limit setting)
Resolution: 10 μ A
Accuracy: $\pm 0.1\%$ of range

Voltage meter (in current function)

Ranges: 100 V
Resolution: 10 mV
Accuracy: $\pm 0.1\%$ of range

Current limit setting (in voltage function)

Ranges: 50 mA
Resolution: 10 μ A
Accuracy: $\pm 0.2\%$ of range

Voltage limit setting (in current function)

Ranges: 100 V
Resolution: 10 mV
Accuracy: $\pm 0.2\%$ of range

8.5. Thermocouples

Resolution: 0.01 °C

Cold junction compensation: manual or automatic (with Adapter 91) in range 0.00 – 40.00 °C

Type	Range	± °C
R (EN60584-1/ITS90)	-50 - -10 °C	0.8 °C
	-10 - 100 °C	0.6 °C
	100 - 400 °C	0.4 °C
	400 - 1768 °C	0.3 °C
S (EN60584-1/ITS90)	-50 - -20 °C	0.7 °C
	-20 - 100 °C	0.6 °C
	100 - 1768 °C	0.4 °C
B (EN60584-1/ITS90)	400 - 500 °C	0.8 °C
	500 - 800 °C	0.6 °C
	800 - 1820 °C	0.4 °C
J (EN60584-1/ITS90)	-210 - -180 °C	0.15 °C
	-180 - 1200 °C	0.1 °C
T (EN60584-1/ITS90)	-200 - -100 °C	0.2 °C
	-100 - 400 °C	0.1 °C
E (EN60584-1/ITS90)	-250 - -200 °C	0.25 °C
	-200 - 1000 °C	0.1 °C
K (EN60584-1/ITS90)	-200 - -100 °C	0.2 °C
	-100 - 900 °C	0.1 °C
	900 - 1372 °C	0.15 °C
N (EN60584-1/ITS90)	-200 - -100 °C	0.3 °C
	-100 - 100 °C	0.15 °C
	100 - 900 °C	0.1 °C
	900 - 1300 °C	0.15 °C
M (General Electric IPTS 68)	-50 - 1410 °C	0.1 °C
C (Hoskins ITS 90)	0 - 100 °C	0.3 °C
	100 - 900 °C	0.2 °C
	900 - 2315 °C	0.3 °C
D (Hoskins ITS 90)	0 - 300 °C	0.3 °C
	300 - 1100 °C	0.2 °C
	1100 - 2315 °C	0.3 °C
G2 (Hoskins ITS 90)	0 - 300 °C	0.5 °C
	300 - 2100 °C	0.2 °C
	2100 - 2315 °C	0.3 °C

Adapter 91 - Pt100 cold junction compensator

Uncertainty: 0.3 °C; 0.1 °C with calibration constants saved in M160

Stability: < 0.05 °C/year (typical)

4W (full version only)

8.6. RTD

Pt summary range: -200 °C to +850 °C
 Ni summary range: -60 °C to +300 °C
 Resolution: 0.01 °C

Type	Range	± °C ²⁾
Pt100 ... Pt1000	-200 ... 0 °C	0.15 °C
	0 ... 850 °C	0.2 °C
Ni100 ... Ni1000	-60 ... 300 °C	0.1 °C

2. Reference temperature range 23 °C ± 2°C

2W (full version only)

Pt summary range: -200 °C to +850 °C
 Ni summary range: -60 °C to +300 °C
 Resolution: 0.01 °C

Type	Range	± °C ³⁾
Pt100 ... Pt1000	-200 ... 850 °C	0.2 °C
Ni100 ... Ni1000	-60 ... 300 °C	0.15 °C

3. Reference temperature range 23 °C ± 2°C

8.7. Resistance

4W (full version only)

Summary range: 10 Ω to 300 kΩ
 Short resistance: < 50 mΩ

Range	±(% of output + Ω) ⁴⁾	
20.0000 Ω	0.05	15 mΩ
200.000 Ω	0.05	15 mΩ
1000.00 Ω	0.02	0
3000.0 Ω	0.02	0
10000 Ω	0.02	0
30.00 kΩ	0.05	0
100.0 kΩ	0.1	0
300 kΩ	0.5	0

4. Reference temperature range 23 °C ± 2°C

2W (full version only)

Terminals:	Hi, Li (adapter)
Summary range:	10 Ω to 300 k Ω
Specification:	add 10 m Ω to the 4W specification
Short resistance:	< 200 m Ω

RTD, Resistance limits

Maximum dissipation power:	0.3 W
Maximum current:	0.2 A
Maximum voltage:	50 Vpk



According to EN ISO/IEC 17050-1:2010 standard as well as 2014/30/EU and 2014/35/EU directives of European Parliament and European Council, MEATEST, spol. s r. o., manufacturer of M160 Precision DC Calibrator, based in Železná 3, 619 00 Brno, Czech Republic, declares that its product conforms to following specifications:

Safety requirements

- EN 61010-1 ed. 2:2010 + A1:2016 + COR1:2019-03

Electromagnetic compatibility

- EN 61000 part 3-2 ed. 5:2019
- EN 61000 part 3-3 ed. 3:2014
- EN 61000 part 4-2 ed. 2:2009
- EN 61000 part 4-3 ed. 3:2006 +A1:2008+A2:2011+Z1:2010
- EN 61000 part 4-4 ed. 3:2013
- EN 61000 part 4-5 ed. 3:2015 + A1:2018
- EN 61000 part 4-6 ed. 4:2014
- EN 61000 part 4-11 ed. 2:2005
- EN 61326-1 ed. 3:2020
- EN 55011 ed. 4:2015 + A1:2016 + A11:2020

Brno

March 25th, 2024

Place

Date



Signature