

RA3100 Omniace

Instruction Manual

ANALOG
DIGITAL



MESSTECHNIK

ADM Messtechnik GmbH & Co. KG

GERÄTE UND SYSTEME FÜR FORSCHUNG • ENTWICKLUNG • VERSUCH • SERVICE

ADM Messtechnik GmbH & Co. KG · Zum Wartturm 9 · 63571 Gelnhäusen
Tel. (06051) 916557-1 · sales@adm-messtechnik.de · www.adm-messtechnik.de

AND
A&D Company, Ltd.

1WMPD4004444B

CAUTION

- (1) Turn off the power when the operation is abnormal.

If it is impossible to trace the causes of an abnormal operation, please contact our sales representative.

- (2) The contents of this manual are subject to change without notice.
- (3) This manual is copyrighted with all rights reserved. This manual may not be reproduced, modified, or translated without the written permission of A&D Company, Limited. No parts of this manual may be transcribed without permission.
- (4) Please let us know if there are any points that are unclear or missing in this manual.
- (5) A&D Company, Limited. will not be held responsible for any damages or loss of income caused by the operation of this device or any direct, indirect, special, or inevitable damages caused by defects in the product, even if there is notice that the corresponding damages may occur. We will also not be held responsible for any third party claims of rights. At the same time, we will not be held responsible for any loss of data. We will not be held responsible for any of such points as those indicated in item (4).

© 2020 A&D Company, Limited.

- Omnice is a registered trademark of A&D Company, Limited.
- Microsoft, Windows, and Windows 10 IoT are trademarks or registered trademarks of Microsoft Corporation in the United States and other countries.
- Product names and company names in this manual are trademarks or registered trademarks of their respective owners in Japan and other countries.
- Software owned by Adobe Corporation in the United States is used based on the SIL Open Font License.

Introduction

We thank you for your purchase of our data acquisition product OMNIACE RA3100 (hereinafter "the RA3100" or "this product").

This instruction manual explains cautions and methods for handling the RA3100 and its optional input modules. Please read this manual before operating this instrument. If you encounter any problems in the manual, please contact our company.



<Instruction manual on CD>

Manual	Contents
RA3100 Instruction Manual	This manual Explains how to handle and configure the RA3100.

Examining Contents in Package

When Opening Package

When opening the package in a warm room during the cold season, open the package after it has reached room temperature to avoid any operational failure due to condensation on the surface of the product.

Examining Contents in Package

This instrument is delivered after a thorough examination at the factory prior to shipment. However, please examine the product's condition and verify that no obvious shipping damage has occurred after opening the package. Also, examine the specifications of the input units and accessories. If there are any missing or damaged items, please contact our sales representative.

<Contents in Package>

Name	Model/document number	Quantity	Remarks
Omniace main unit	RA3100	1	AC 100 V to 240 V
Simple Operation Manual	1WMPD4004445B	1	Describes cautions on use and operation methods
Instruction Manual CD-ROM	1WMEK4010464	1	Includes the RA3100 Instruction Manual
AC power cable		1	The cable selected at ordering the product.
Thermal recording paper	YPS-106	1 roll	30 m roll recording paper (5 rolls per box)
Recording paper holder	5633-1794	2	Recording paper both edges x 1 each

<Contents in Module Package>



Name	Model/document number	Quantity	Remarks
Two channel voltage module	RA30-101	Any one module	
Four channel voltage module	RA30-102		
Two channel high-speed voltage module	RA30-103		
16 channel logic module	RA30-105		
Two channel temperature module	RA30-106		Two sensor connector sets included
Remote control module	RA30-112		
"Before Using This Product"	1WMPD4004140A		

To Safely Use Products



Safety Measures - Warnings and Cautions

- This product is designed and tested to conform to the EN61010 standard.
- The product is manufactured with safety in mind. However, accidents may occur due to misuse by the user. To avoid such accidents, read this manual carefully before use. Observe the following warning and cautions when using the product. The following statements are used in this manual to call the readers' attention.
- Be sure to observe the following instructions when using this product. The warranty does not cover damages resulting from the actions against instructions, cautions, or warnings mentioned in this manual. Besides, there are a lot of actions that are "cannot" and "do not". It is impossible to write all such descriptions in this manual. Accordingly, assume any actions to be "impossible" except the actions explicitly described as "possible".

Meaning of Warning Signs

 WARNING	This indicates a condition or practice that could result in personal injury or loss of life, or may result in light injury or physical damage if this equipment is misused due to neglect of a Warning.
 CAUTION	This indicates a condition or practice that could result in light injury or damage to the equipment or other property if this equipment is misused due to neglect of a Caution.

Meaning of Symbols

	△ symbols indicate cautions (including warnings). Specific precautions are indicated inside figures (in the example on the left, a warning about electrocution).
	⊘ symbols indicate prohibited actions. Specific prohibited actions are indicated inside ⊘ or with nearby text or pictures. The example on the left indicates that disassembly is prohibited.
	● symbols indicate actions that must be taken. Specific actions that must be taken are indicated inside ● or with nearby text or pictures. The example on the left indicates an action that must be taken.

WARNING

Power

- Make sure that the power supply is within the rating indicated on the rating plate attached to this product.

If any voltage exceeding the rated voltage was supplied, there would be risk of damage to this product, or even a fire. Also, in order to prevent electric shock and hazards such as a fire, be sure to use only the AC power cable supplied with this product.

WARNING

Protective Grounding

- Be sure to ground this product before supplying power. Grounding is necessary to use this product safely, as well as to protect the user and peripheral equipment from injury or damage. Be sure to observe the following instructions:
- The AC power cable included with this product contains a ground lead. Connect the power cable into only a 3-pin AC outlet with a ground pole.
- When grounding, do not connect the grounding lead to a water pipe, as water pipes are not necessarily conductive to the earth. Never connect the ground lead to a gas pipe either, as it is extremely dangerous.
- While the power is supplied to the product, do not cut or remove the protective grounding line. Otherwise, safety of the product is not guaranteed.

Overvoltage Category (Installation Category)

- This product's Overvoltage Category is Category II. Do not use the product with higher categories, as connecting it to the line of a distribution board, etc. (CAT III) or the lead-in wire of a main power line (CAT IV) may lead to device failure.

Measurement Category

- The measurement input terminal Measurement Category of this product differs according to the installed modules.
Use the product for measurement within the Measurement Category that meets the module specifications. Do not use it with a Measurement Category that exceeds the module specifications.

Connection of Input Signals

- Be sure to ground the grounding terminal of this product before connecting to the measurement target. Also, when connecting this product to another measurement instrument, be careful not to exceed the maximum allowable common mode input voltage range.
A voltage exceeding the range can cause damage to this product.

Use in Gaseous Atmosphere

- Never use this product in a flammable or explosive atmosphere, or an atmosphere containing steam. Use in such atmosphere will result in danger to users and the product.

Disassembling the Frame

- It is dangerous to remove the frame of this product due to the high-voltage parts inside. The frame must not be removed from the product other than by our service engineers.

Fuse at AC Power Supply Block

- The fuse for this product cannot be replaced by the customer because it is located inside the main unit. Please contact our sales representative if the fuse may be blown.

Handling of Back-up Battery (Cautions when Disposing)

- This product includes a coin-type lithium battery (primary cell).
When disposing of this product, remove the battery in advance.
Do not dispose of the battery in fire or disassemble. The battery may explode when it is heated and organic electrolyte that may exude from it is harmful to human skin. When disposing of the battery, isolate the terminals by covering with tape and dispose the battery as a dangerous article.

 **CAUTION****Caution in Handling**

When using this product, always follow the precautions below. Improper handling may lead to erroneous operations and damages.

- Users who are not familiar with the operation of this product should avoid using it.
- Use this product at locations that satisfy the overvoltage requirement, the Category II (CAT II) of the safety standard for electrical measurement instruments in EN61010-1.
- This product has a Pollution Degree of 2.
- This product is a Class A product for industrial environments.
Use in household environments may cause electromagnetic interference. In such cases, the user must implement appropriate countermeasures.
- Store this product in the following storage environments. Avoid storing in places where the temperature could rise over the storage temperature and where there is direct sunlight exposure such as inside an automobile.
Storage temperature range: -20 to 60°C Storage humidity range: 20 to 85% RH (without condensation)
- Use this product in the following operating environments.
Operating temperature range: 0 to 40°C Operating humidity range: 35 to 85% RH (without condensation)
- Do not use this product at the following locations. In addition, carefully check the environment when using this product.
 - Locations where the temperature and humidity rise due to direct sunlight or heaters
 - Wet locations
 - Locations where salt, oil, or corrosive gases exist
 - Dusty locations
 - Locations subject to strong vibrations
 - Locations with a strong electromagnetic field
 - This product is provided with ventilation openings in order to prevent overheating.
Ensure that the ventilation openings remain unobstructed by covers or materials. Otherwise, the internal temperature of the product rises, causing malfunctions.
 - Do not place highly combustible objects such as paper near the product.
- Be careful of power voltage fluctuations. Do not use the product when these are likely to exceed the rated voltage.
- If the power supply includes a lot of noise or high-voltage inductive noise, use noise filters to avoid operation errors.
- A solid-state drive is installed in this product.
Please don't power off during normal operation of the SSD (while data is being saved/read), due to the risk of data destruction.

 **CAUTION**

- This product uses an electrostatic capacitive touch panel.
Press the touch panel gently with your bare fingertip. The touch screen may not react if you are wearing gloves. Also do not use a sharp object or push with higher pressure than necessary. Pressing three or more locations at once may cause misoperations. Be sure to press only one location when making a selection or two locations with pinching in/pinching out.
- LCD display
This product has a TFT color LCD for display. There may be cases where the light of pixels does not come on or off in the LCD. In addition, the LCD includes unevenness slightly due to temperature changes. Please be aware that these cases are not disorders.
- Use the chart recording paper specified by A&D. Use of a chart that is not recommended may cause failure in printing or shorten the life of the thermal head.
- Recording straight line waveforms or waveforms in solid black in the same position for an extended period of time may shorten the life of the elements in that part of the thermal head. It is recommended that the waveform recording position is occasionally changed.
- Printing a waveform in solid black for an extended period of time causes printing waste of the recording paper to remain in the thermal head, and may prevent printing. Periodically clean the thermal head.
- When storing the product for an extended period of time, the recording paper feeding platen may become deformed if the printer cover is locked and cause printing irregularities, but this does not indicate product failure.
- When storing recording paper for an extended period of time before recording, remove the recording paper from the main unit and insert it in a plastic bag, or as-is if it is still in its original packaging, and then store it in a dark location with a temperature of 25°C or less and humidity of 70% RH or less.
- When storing recording paper for an extended period of time after recording, file it in a dark location with a temperature of 25°C or less and humidity of 70% RH or less. When using a file folder, make sure that it is made of a material that does not include plasticizer (such as polyethylene or polypropylene).
- If the recording paper touches the following materials or products, the printing surface may change color, lose color, or exhibit otherwise poor color performance.
Vinyl chloride products, organic compounds, adhesive tape, pencil eraser, rubber mats, magic markers, felt-tip pens, correction fluid, carbon, diazo photosensitive paper, hand cream, hairdressing products, cosmetic products, or leather products such as a wallet
- Do not insert a pointed or sharp object into the ventilation openings of this product.
- To clean this product, first turn off the power, place it in a well-ventilated location, and wipe the product using soft cloth moistened with ethanol. Do not use benzene, petroleum solvents, or chemically treated cloths, as they can cause deformation or discoloration.
- When transporting the product, use the package and packaging material supplied at factory shipment, or use a package and packaging material more shock-resistant than those supplied.
- We recommend a periodical calibration to maintain the accuracy of the input units. More reliable measurements are possible by calibrating the input units once a year (extra cost option).

! CAUTION

Windows 10 IoT

This product adopts Windows 10 IoT as its operating system. Please read and understand the following instructions carefully before use.

License

The Windows 10 IoT operating system used in this product is provided with a license for embedded use only.

This product cannot function as a general purpose PC, and it is limited exclusively for RA3100 use. The embedded system of this product is not allowed to be duplicated and used.

Power on/off

This product enters the standby state when the AC power cable is connected, where it consumes a tiny amount of standby power. When the **Power** switch on the panel is pressed, the main power starts and the product enters the monitoring state.

When turning off the power, confirm that the internal SSD of the product is not being accessed.

When the **Power** switch is pressed, the [Shutdown] screen is displayed. Tap **【Yes】** to shutdown the product. Directly removing the power cable to turn off the power may damage the data on the SSD and make the SSD unable to be used.

When the product will not be used for an extended period of time, remove the power cable after the shutdown process is complete.

Use on a Network

Please consult your network administrator to make sure that other tasks are not affected by connecting this product to the network.

Computer Viruses

This product does not include any virus search or removal software other than the standard Windows functions, in order to ensure it maintains adequate performance. Take care when connecting the product to a network or external media.

Other

We do not assume any responsibility or provide support for malfunctions if programs that are not provided by us are installed into the system, the operating system settings are changed, or programs are forcibly terminated via an input device such as a keyboard or mouse.

Disposing of the Used Product

In the European Union

EU-wide legislation as implemented in each Member State requires that used electrical and electronic products carrying the mark (right) must be disposed of separately from normal household waste. This includes electrical accessories, such as chargers or AC adapters.

The mark on the electrical and electronic products only applies to the current European Union Member States.











Outside the European Union

If you wish to dispose of used electrical and electronic products outside the European Union, please contact your local authority and ask for the correct method of disposal.

Symbols in This Manual

Terms and symbols used in this manual denote as follows.

 WARNING	This indicates a condition or practice that could result in personal injury or loss of life, or may result in light injury or physical damage if this equipment is misused due to neglect of a Warning.
 CAUTION	This indicates a condition or practice that could result in light injury or damage to the equipment or other property if this equipment is misused due to neglect of a Caution.
NOTE	This indicates a condition or practice that could result in incorrect operation or damage to data if this equipment is misused due to neglect of a Note, as well as measurement limitations and additional explanations.
	Reference page
	A tap is the act of lightly touching an item such as a key displayed on the screen with a finger. Example Used for selecting or setting screen keys.
	A swipe is the act of pressing the screen with a finger and moving it in a specific direction. Example Used on screens such as the [Thumbnail] screen and [Channel Setup] screen.
	A pinch in is the act of touching the screen with two fingers and moving those fingers closer to each other, and reduces the screen. Example Used to reduce the content displayed on the screen, waveform amplitude, or time axis, etc.
	A pinch out is the act of touching the screen with two fingers and moving those fingers apart from each other, and enlarges the screen. Example Used to enlarge the content displayed on the screen, waveform amplitude, or time axis, etc.
 key	Enclosed characters represent a key name on the operation panel. Example  key
[] key	Text enclosed in [] indicates touch panel keys displayed on the screen. Example [CH] key
[] screen	Text enclosed in [] indicates the text of items on the screen. Example [Module 1]
k (lower case) K (upper case)	Example 1 kg = 1000 g 1 KB = 1024 bytes

Warranty

Warranty - General

We ship our products after conducting quality control, which covers from design to manufacturing. It is, however, possible that failures may occur in the products. If the product does not operate correctly, please make a check of the power supply, cable connections, or other conditions before returning this product to us.

For repair or calibration, contact our sales agency. Before returning, be sure to inform us of the model (RA3100), serial number, and problematic points.

The following is our warranty.

Limited Warranty

1. Warranty period: One year from our shipment.
2. Warranty scope: The warranty only covers the main unit of the product.
We will repair the defects of our product free of charge within the warranty period; however, this warranty does not apply in the following cases.
 - Damage or faults caused by incorrect use
 - Damage or faults caused by fire, earthquake, traffic accident, or other natural disasters
 - Damage or faults caused by a repair or modification that is carried out by someone other than a service representative of A&D
 - Damage or faults caused by use or storage in environmental conditions that should be avoided
 - Periodical calibration
 - Damage or faults caused during transportation.
 - The thermal printing head may not be covered by the warranty even within the warranty period, depending on the usage conditions.
Usage conditions: 30 million printing pulses or more or recording length 30 km or longer
 - The internal SSD, fan, and backup coin-type battery are treated as consumables and not covered by the warranty.
 - Data recorded on the SSD and external media is not covered by the warranty, regardless of the cause and type of product failure. Make sure to back up your recorded data.
3. Liability: We do not assume any liability for equipment other than A&D equipment.

CONTENTS

INTRODUCTION	3
EXAMINING CONTENTS IN PACKAGE	4
TO SAFELY USE PRODUCTS.....	5
DISPOSING OF THE USED PRODUCT.....	9
SYMBOLS IN THIS MANUAL.....	10
WARRANTY	11
1. NAME AND FUNCTION OF EACH BLOCK.....	17
1.1. Name of Each Block.....	17
1.2. Display Block.....	19
1.3. Operation Panel	20
1.4. Interface Block.....	21
1.5. Input Module Block.....	21
1.6. Screen and Setup Menu.....	22
1.6.1. Side menu	22
1.6.2. Control Bar	23
2. PRE-MEASUREMENT PROCEDURES	25
2.1. Before Switching On the Power	25
2.1.1. Installation and Usage Environment.....	25
2.1.2. Installing Optional Modules	27
2.1.3. Paper Loading	28
2.2. Turning the Power On/Off.....	33
2.2.1. Connecting the AC Power Cable.....	33
2.2.2. Turning On the Power	33
2.2.3. Confirming Normal Startup.....	34
2.2.4. Setup Date and Time.....	34
2.2.5. Preparing for More Precise Measurements	34
2.2.6. Turning Off the Power	34
3. FLOW OF MEASUREMENT	35
3.1. Flow of Measurement.....	35
4. CONFIGURING MEASUREMENT	36
4.1. Reducing the Input Sensitivity and Connecting the Input Cable	36
4.2. Setting the Input Channel.....	38
4.2.1. Channel setup sub menu (for RA30-101)	38
4.2.2. Setup the input channels	39
4.3. Selecting the Recording Method	44
4.3.1. Recording to Recording Paper Only.....	44
4.4. Recording Setup.....	45
4.4.1. Setup the Sampling Speed.....	45
4.4.2. Sampling Speed of Recording Device	46
5. TRIGGER SETUP	47
5.1. Trigger Types.....	47
5.2. Memory trigger	47
5.2.1. Memory Trigger Setup	47

5.3.	Pre-Trigger	50
5.3.1.	Pre-Trigger Setup	50
5.4.	Start Trigger	51
5.4.1.	Start Trigger Setup	51
6.	MEASURING INPUT SIGNALS	52
6.1.	State Transition of Main Unit Operation	52
6.2.	Monitor Display and Pen Recording	53
6.2.1.	Monitor Display Function	53
6.2.2.	Pen Recording	56
6.2.3.	Setup and Printing Annotations	58
6.3.	Starting and Ending Recording	62
6.3.1.	Recording Setup	62
6.3.2.	Starting and Ending Recording	69
6.3.3.	Pausing Recording and Scrolling Back	70
7.	PLAYBACK RECORDED DATA	71
7.1.	Select Recorded Data	71
7.2.	Playback Recorded Data	72
7.2.1.	Playback Screen Operations	72
7.2.2.	Thumbnails	73
	Thumbnail display channel	74
7.2.3.	Cursor	75
7.2.4.	Printing Out	76
7.3.	X-Y Waveform	77
7.3.1.	X-Y Display Setup	77
7.3.2.	X-Y Control	78
7.4.	FFT Analysis	79
7.5.	Search Function	80
7.5.1.	Search Types and Operations	80
7.5.2.	Search Method Types and Settings	82
7.5.3.	Peak Value Search (Maximum/Minimum)	84
7.5.4.	Peak Value Search (Local Maximum/Local Minimum)	85
7.5.5.	Level Search (LEVEL UP/LEVEL DOWN)	87
7.5.6.	Window Search (INTO WIN/OUT WIN)	89
7.5.7.	Logic Search	92
7.5.8.	Trigger Search	93
7.5.9.	Mark Search	93
7.5.10.	Search Display Menu	94
7.6.	Jump Function	95
7.6.1.	Jump Types and Operations	96
7.6.2.	Jump Condition Types and Settings	97
7.6.3.	Data beginning, center, end	98
7.6.4.	Date Setup	98
7.6.5.	Time Setup	99
7.6.6.	POINT(samples)	99
7.6.7.	Cursor	100
8.	SETUP DETAILS	101
8.1.	Recording Setup	101

CONTENTS

8.1.1.	Recording	101
8.1.2.	Channel List.....	102
8.1.3.	Sheet Setup.....	105
8.1.4.	Printer	108
8.2.	Main Unit Setup.....	111
8.2.1.	Record management.....	111
8.2.2.	Export - Backing Up Recorded Data	113
8.2.3.	Import - Reading Backup Data	114
8.2.4.	Image Management.....	115
8.2.5.	Environment Setup.....	117
8.2.6.	Display Setup	121
8.3.	Other setup.....	122
8.3.1.	Maintenance	123
8.3.2.	Operation History.....	125
8.3.3.	Version Management	125
9.	USING OPTIONAL MODULES	126
9.1.	Two Channel Voltage Module (RA30-101).....	126
9.1.1.	Overview.....	126
9.1.2.	Setting the Input Channel.....	126
9.1.3.	Measurement Setup	127
9.1.4.	Reference Materials	129
9.2.	Four Channel Voltage Module (RA30-102).....	130
9.2.1.	Overview.....	130
9.2.2.	Setting the Input Channel.....	130
9.2.3.	Measurement Setup	131
9.2.4.	Reference Materials	133
9.3.	Two Channel High-Speed Voltage Module (RA30-103).....	134
9.3.1.	Overview.....	134
9.3.2.	Setting the Input Channel.....	134
9.3.3.	Measurement Setup	135
9.3.4.	Reference Materials	137
9.4.	16 Channel Logic Module (RA30-105).....	138
9.4.1.	Overview.....	138
9.4.2.	Setting the Input Channel.....	138
9.4.3.	Measurement Setup	140
9.4.4.	Reference Materials	141
9.4.5.	Options	142
9.5.	Two Channel Temperature Module (RA30-106).....	143
9.5.1.	Overview.....	143
9.5.2.	Setting the Input Channel.....	143
9.5.3.	Measurement Setup	144
9.5.4.	Reference Materials	145
9.5.5.	Spare Parts.....	149
9.6.	Remote Control Module (RA30-112).....	150
9.6.1.	Overview.....	150
9.6.2.	Installation	150
9.6.3.	Channel setting.....	151
9.6.4.	Output terminal for waveform confirmation	152

9.6.5.	Measurement Setup	152
9.6.6.	Reference Materials	153
9.6.7.	Options	157
10.	APPENDIX	160
10.1.	Sampling Data Format	160
10.1.1.	Normal Sampling	160
10.1.2.	P-P Sampling	160
10.2.	Sampling	161
10.2.1.	Internal Sampling	161
10.2.2.	External Sampling	161
10.2.3.	Relationship between Sampling Speed and Chart Speed	161
10.3.	Scale Conversion (Physical Quantity Conversion)	162
10.4.	FFT Analysis	163
10.4.1.	Analysis Function	163
10.4.2.	AVG process	166
10.4.3.	Units of Analysis Results	167
10.5.	Setup Information after Executing Initialization	168
11.	MAINTENANCE	170
11.1.	Managing/Handling Recording Paper and Printer Recorded Data	170
11.1.1.	Replacing Recording Paper and Monitoring Remaining Paper	170
11.1.2.	Storing Recording Paper	170
11.1.3.	Printer Block Errors	171
11.2.	Backing Up Recorded Data	171
11.2.1.	Internal SSD Errors	172
11.3.	Display Cleaning	172
11.4.	Thermal Head Cleaning/Life	172
11.4.1.	Cleaning	172
11.4.2.	Life	172
11.5.	Platen Roller Maintenance	172
11.6.	Power Outages	173
11.7.	Battery Replacement	173
11.8.	Fan Replacement	173
11.9.	Cautions for Disposing This Product	173
11.10.	Troubleshooting and Inspection	174
12.	SPECIFICATIONS	175
12.1.	General Specifications	175
12.1.1.	Main Unit Basic Specifications	175
12.1.2.	General Specifications	176
12.2.	Functional Specifications	178
12.2.1.	Measurement Function	178
12.2.2.	SSD Recording	178
12.2.3.	Memory Recording	179
12.2.4.	Printer Recording	179
12.2.5.	Trigger Function	180
12.2.6.	Waveform Monitor Function	181
12.2.7.	X-Y Waveform	182
12.2.8.	FFT Analysis	182

CONTENTS

12.2.9.	Setup/Record management	183
12.2.10.	Interface Specifications	184
12.2.11.	Communication Setup	185
12.2.12.	Other Setup (Maintenance/Operation History/Version Management).....	186
12.3.	Module Specifications	187
12.3.1.	Two Channel Voltage Module (RA30-101)	187
12.3.2.	Four Channel Voltage Module (RA30-102)	188
12.3.3.	Two Channel High-Speed Voltage Module (RA30-103).....	189
12.3.4.	16 Channel Logic Module (RA30-105).....	190
12.3.5.	Two Channel Temperature Module (RA30-106).....	191
12.3.6.	Remote Control Module (RA30-112)	193
12.4.	Exterior	194
12.4.1.	Main Unit Exterior	194
12.4.2.	Two Channel Voltage Module (RA30-101) Exterior	195
12.4.3.	Four Channel Voltage Module (RA30-102) Exterior.....	196
12.4.4.	Two Channel High-Speed Voltage Module (RA30-103) Exterior	197
12.4.5.	16 Channel Logic Module (RA30-105) Exterior	198
12.4.6.	Two Channel Temperature Module (RA30-106) Exterior	199
12.4.7.	Remote Control Module (RA30-112) Exterior.....	200
13.	OPTIONAL PARTS.....	201
13.1.	List of Cables.....	201
13.2.	List of Probes/Clamp Meters	202
13.3.	Accessory	203
13.4.	List of Spare Parts	204
SOFTWARE LICENSE INFORMATION		205

1. Name and Function of Each Block

This product consists of the following blocks.

1.1. Name of Each Block

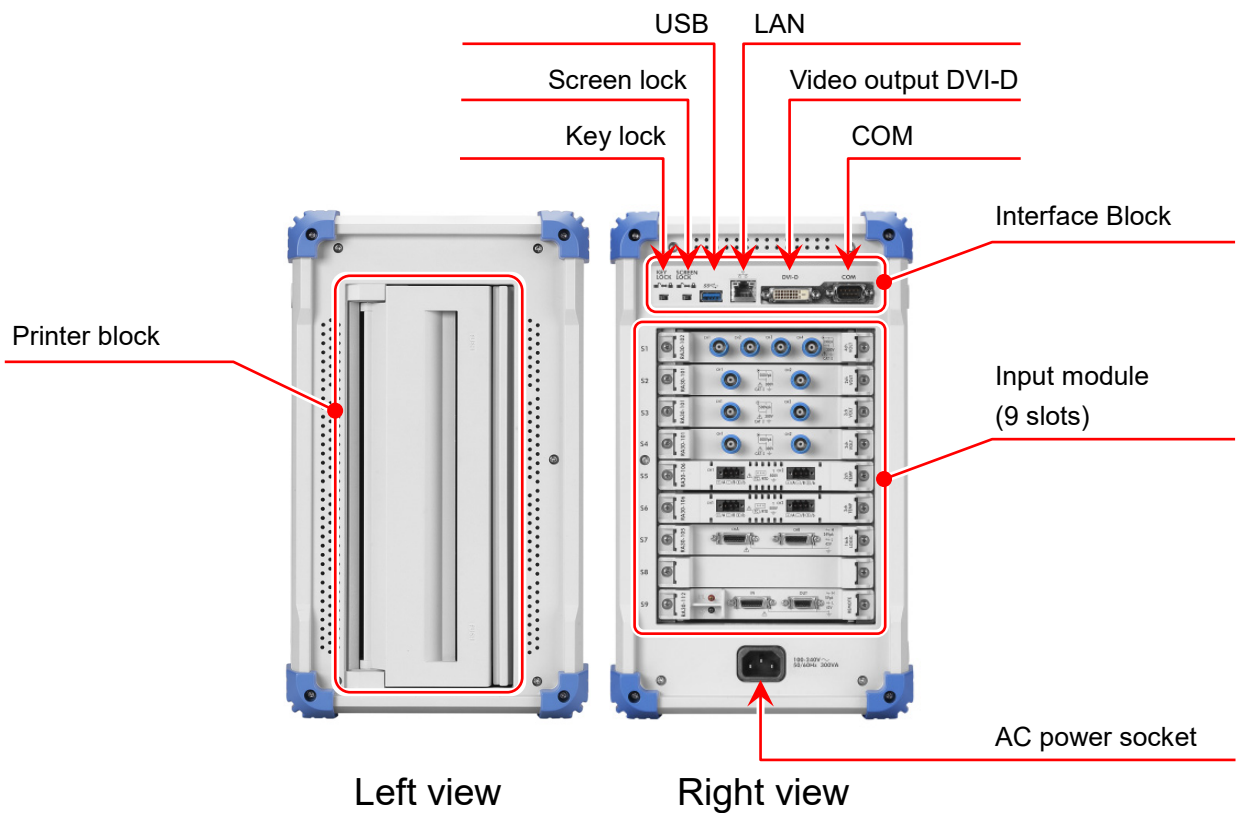
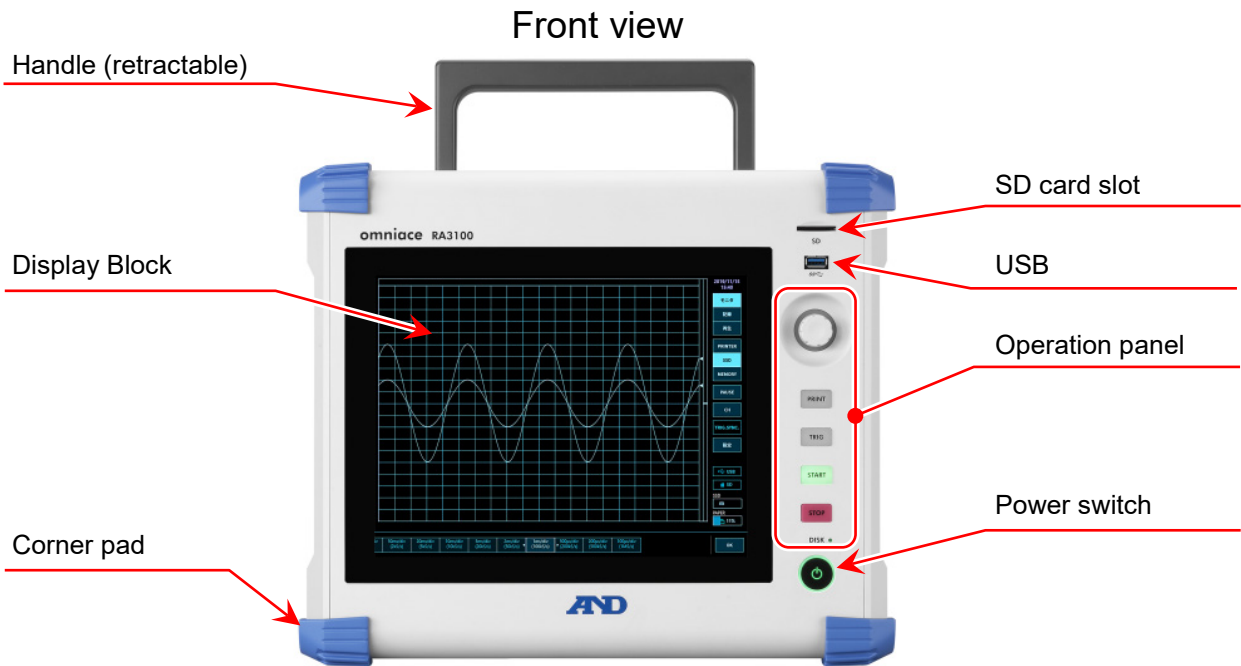

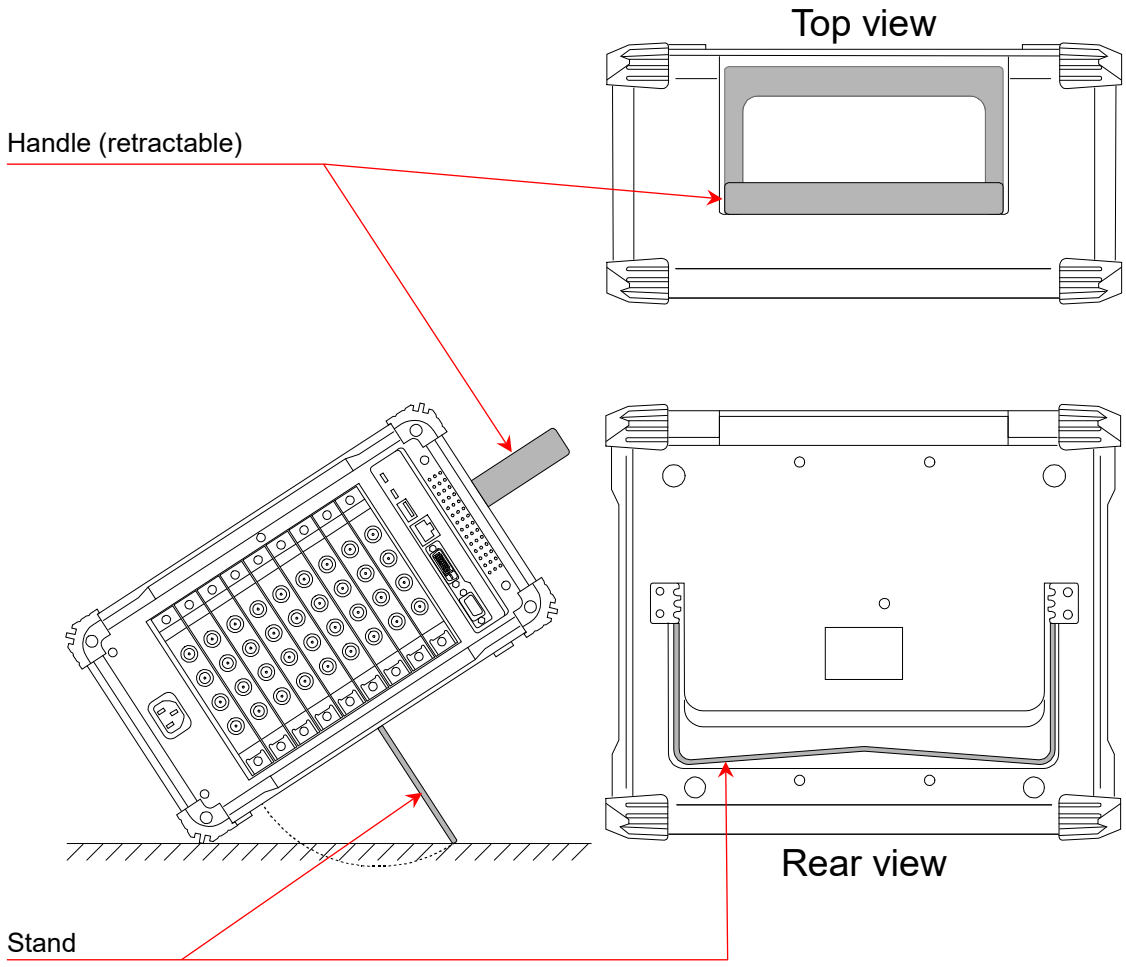

1.2. Display Block

This product has a TFT color LCD display with touch panel.

The LCD displays the waveform monitor and setup keys, and users can configure setup by directly touching the panel.

Waveform monitor

Side menu

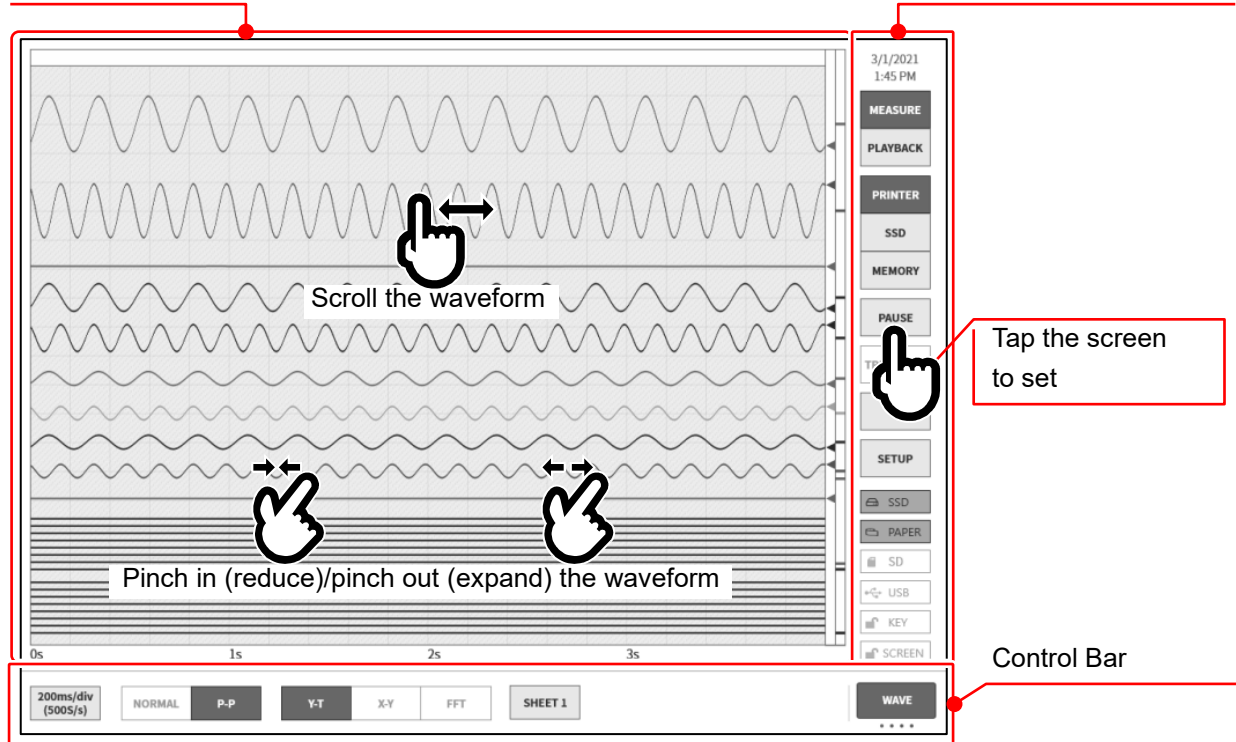

Waveform monitor: You can observe the state of the input signal and play back the recorded data on the waveform monitor. Pinch in/out to enlarge or reduce the waveform or scroll the waveform.

Side menu: Used to switch the display screen, configure the various input modules, configure the recording conditions, configure recording, set triggers, and display digital data, etc.

Control bar: The control bar provides a menu for the functions frequently used with the waveform monitor, such as the basic control of sampling, etc., thumbnail display, cursor display, and the pen recorder function.

NOTE

- The pen recorder control function enables waveform recording to a printer using operations that simulate a conventional pen recorder.
- This product uses an electrostatic capacitive touch panel. The touch screen may not react if you are wearing gloves.

1.3. Operation Panel

(1) SD card slot
Used to save recorded data to an SD memory card, etc.

(2) USB
Used to save recorded data to USB memory, etc. in the same manner as to an SD memory card.

(3) Rotary knob
Used to select the module ranges and setting values by turning it clockwise and counterclockwise.
When the rotary knob is enabled, the area around the knob lights in the blue color of the normal mode.
Push the rotary knob to switch the area around the knob to the orange of the fine adjustment mode.
Push it again to return the area around the knob to the blue color of the normal mode.

(4) **PRINT** key
Outputs the waveform recording to the printer.
Press the **PRINT** key to start waveform recording and again to end recording. You can also press the **STOP** key to end recording. Press and hold the **PRINT** key to output a copy of the screen (screenshot) to a printer, which can be saved to the main unit or external media in the .png file format.

(5) **TRIG** key
Press the key to output a forced trigger.
The TRIG LED lights when a trigger is detected.

(6) **START** key
Starts recording.

(7) **STOP** key
Ends recording.

(8) DISK access light
The LED lights when accessing the internal SSD (for reading or writing).

(9) **Power** switch
Turns the power of the main unit on/off.
The [Shutdown] screen is displayed when turning the power off. Press the **OK** key to complete the shutdown process.
If this **Power** switch is pressed again while the [Shutdown] screen is displayed, the product automatically shuts down.

1.4. Interface Block

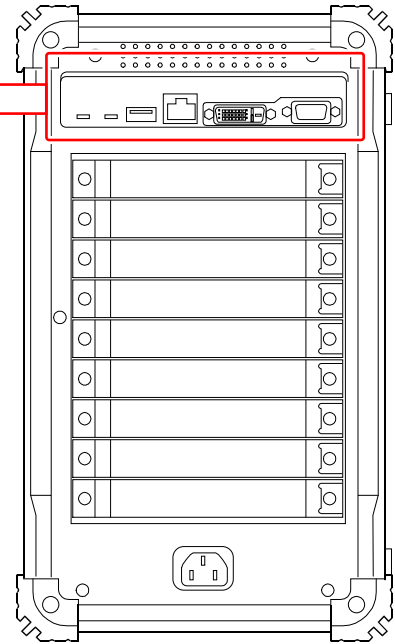
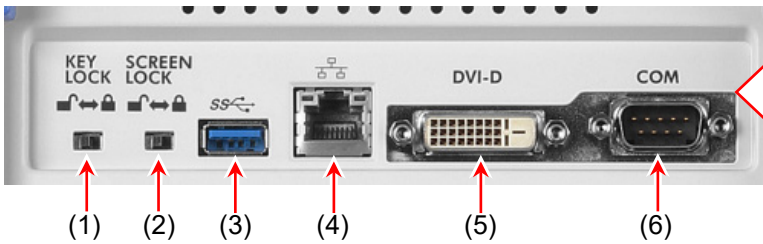

- (1) Key lock
Disables the operation panel keys to prevent misoperations.
- (2) Screen lock
Disables the touch panel keys to prevent misoperations.
- (3) USB
Used to save recorded data, etc. Supports USB 3.0.
- (4) LAN
Used to perform remote control from an external PC via LAN.
- (5) DVI-D
The video output terminal.
- (6) COM
Used to perform remote control from an external PC via RS-232C.

1.5. Input Module Block

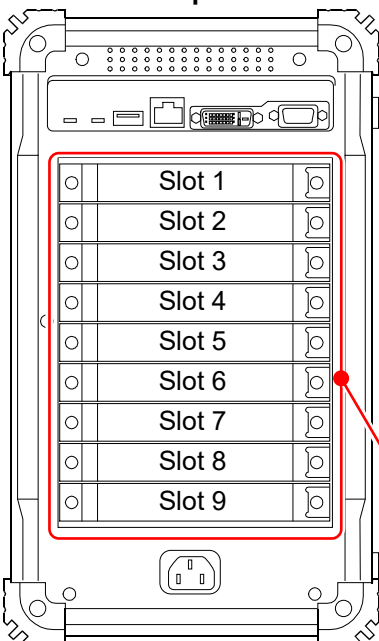

- Up to nine modules can be installed to the input module block of the product.
- For information on using each module, see "[9. Using Optional Modules](#)" and "[12. Specifications](#)".
- Standard signal input modules can be installed in any of Slot 1 to Slot 9.
- Select and install a module according to the target for measurement.
- The RA30-112 (remote control module) can only be installed to Slot 9.

Input module (9 slots)

1.6. Screen and Setup Menu

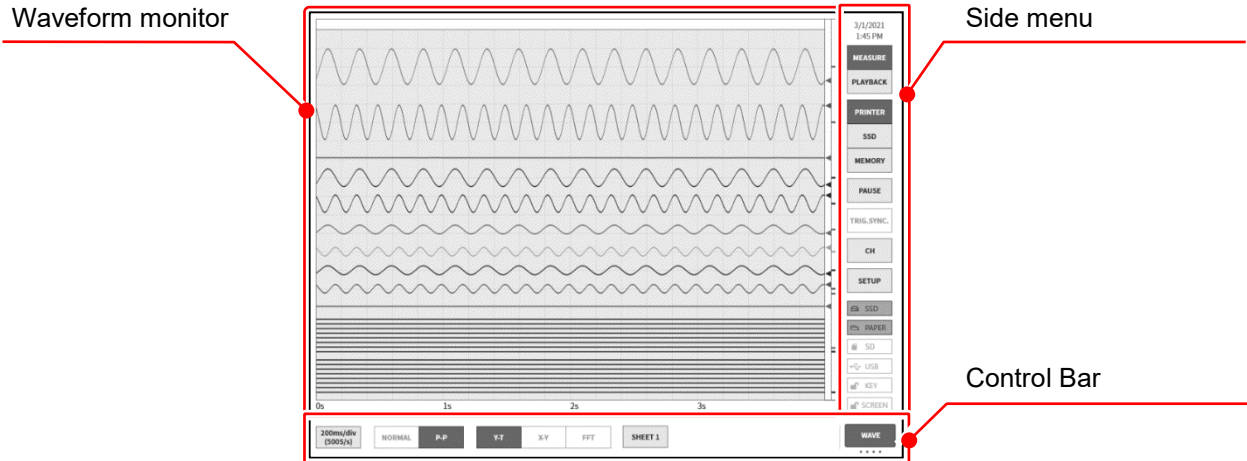

1.6.1. Side menu

	<p>(1) Time: Displays the current time</p> <p>(2) MEASURE/PLAYBACK: Switches the displayed waveform MEASURE: Displays the current input waveform. PLAYBACK: Displays the playback waveform of the saved data.</p> <p>(3) Recording device: Select waveform recording device to display Displays the recorded waveform for PRINTER/SSD/MEMORY.</p> <p>(4) PAUSE: Pauses the waveform displayed on the waveform monitor.</p> <p>(5) TRIG.SYNC: Updates the input waveform display of a memory recording by synchronizing it with a trigger.</p> <p>(6) CH: The input channel setup Opens the channel setup sub menu to configure the channel setup, input digital display, and trigger setup.</p> <p>(7) SETUP: Opens the setup menu to configure the detailed settings of the product. Recording setup (Recording/Channel list/Sheet/Printer) Main unit setup (Record management/Image management/Environment/Display) Other setup (Maintenance/Operation history/Version management)</p> <p>(8) SSD: Displays the remaining space on the internal SSD. An error is displayed when the remaining space is low.</p> <p>(9) PAPER: Displays the remaining amount of recording paper in the printer block. An error is displayed when the remaining amount of recording paper is low. Press and hold this key to initialize the recording paper type (roll paper or Z-fold paper) and usage amount. When replacing the recording paper, press and hold this key to initialize the remaining amount of recording paper.</p> <p>(10) SD: Lights when an SD memory card is inserted in the SD card slot and recognized as external memory.</p> <p>(11) USB: Lights when a USB stick is inserted in the USB port and recognized as external memory.</p> <p>(12) KEY: Lights when the KEY LOCK switch on the side of the main unit is set to on to disable the operation panel keys.</p> <p>(13) SCREEN: Lights when the SCREEN LOCK switch on the side of the main unit is set to on to disable the display touch panel.</p>
--	--

1.6.2. Control Bar

The control bar provides a menu for the functions frequently used with the waveform monitor, such as waveform display control of sampling, etc., thumbnail display, cursor display, and the pen recorder function.

Tap the (7) **【Display switch】** key on the right edge of the control bar to switch the functions in the order indicated below.

【PEN REC】 (pen recording) is only available when printer recording is selected.

【WAVE】 ⇒ **【THUMBNAIL】** ⇒ **【CURSOR】** ⇒ **【PEN REC】**

WAVE (waveform)

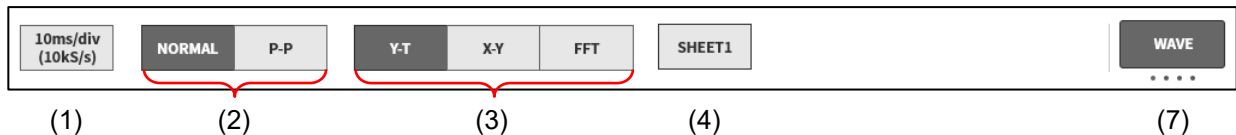

- (1) Sampling speed : Selects the sampling speed. The speed table differs according to the recording device.
- | | | | |
|-------------------|-----------------------|----|--|
| Printer recording | : 1 kS/s (100 ms/div) | to | 10 S/s (10 min/div), EXT (external sampling) |
| SSD recording | : 1 MS/s (100 μs/div) | to | 10 S/s (10 min/div), EXT (external sampling) |
| Memory recording | : 20 MS/s (5 μs/div) | to | 10 S/s (10 min/div) |
- (2) Data format : Selects either NORMAL or P-P as the format for the recorded data.
Only P-P is available for printer recording.
Only NORMAL is available for memory recording.
- (3) Waveform format : Selects Y-T, X-Y, or FFT as the waveform format.
X-Y display and FFT analysis are only available when SSD recording is set.
- (4) Sheet selection : Selects the waveform set to display on the screen.
- (7) Display switch : Switches in the order **【WAVE】** → **【THUMBNAIL】** → **【CURSOR】** → **【PEN REC】**.

THUMBNAIL



See "[7.2.2 Thumbnails](#)".

CURSOR

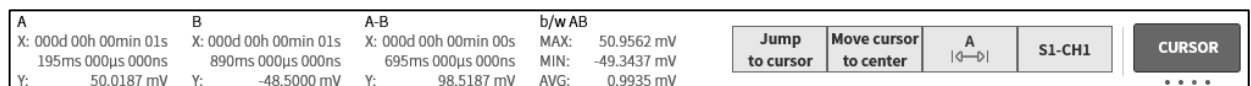

See "[7.2.3. Cursor](#)".

PEN REC (pen recording)

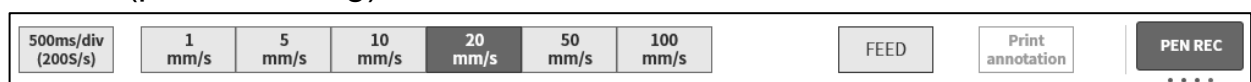

See "Other setup" in "[8.1.4 Printer](#)".

Control bar when playback

Touch the **【PLAYBACK】** key on the [side menu](#) to enter the playback mode and switch the control bar to the menu for playback.



- (1) Sampling speed : Displays the sampling speed of the recorded data.
 Printer recording : 1 kS/s (100 ms/div) to 10 S/s (10 min/div), EXT (external sampling)
 SSD recording : 1 MS/s (100 μ s/div) to 10 S/s (10 min/div), EXT (external sampling)
 Memory recording : 20 MS/s (5 μ s/div) to 10 S/s (10 min/div)
- (2) Data format : Displays either NORMAL or P-P as the format for the recorded data.
 Only P-P is available for printer recording.
 Only NORMAL is available for memory recording.
- (3) Waveform format : Selects Y-T, X-Y, or FFT as the waveform format.
 X-Y display and FFT analysis are only available when SSD recording is set.
- (4) Sheet selection : Selects the waveform set to display on the screen.
- (5) DATA : Selects and play back recorded data.
- (6) DATA information : The information of the displayed playback data.
- (7) Display switch : Switches the functions in the order **【WAVE】** → **【THUMBNAIL】** → **【CURSOR】** → **【PEN REC】**.

2. Pre-Measurement Procedures

2.1. Before Switching On the Power

The preparations for using this product and the cautions are explained below.

2.1.1. Installation and Usage Environment

Use this product on a flat, level surface.

When using the printer, install it so that the recording paper is level as indicated in the figure on the right.

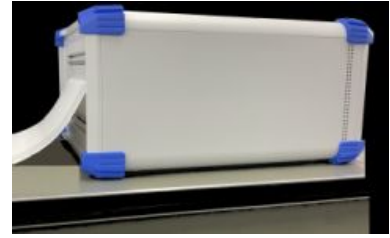

⚠ CAUTION

Cautions Regarding the Installation Environment

- ❑ Use this product at locations that satisfy the installation requirement, the Category II (CAT II) of the safety standard for electrical measurement instruments in EN61010-1.
- ❑ This product has a Pollution Degree of 2.
- ❑ Use this product in the following operating environments.
Operating temperature range: 0 to 40°C Operating humidity range: 35 to 85% RH (without condensation)
- ❑ Do not use this product at the following locations. In addition, carefully check the environment when using this product.
 - Locations where the temperature and humidity rise due to direct sunlight or heaters
 - Wet locations
 - Locations where salt, oil, or corrosive gases exist
 - Dusty locations
 - Locations subject to strong vibrations
 - Locations with a strong electromagnetic field
 - This product is provided with ventilation openings in order to prevent overheating. Ensure that the ventilation openings remain unobstructed by covers or materials. Otherwise, the internal temperature of the product rises, causing malfunctions.

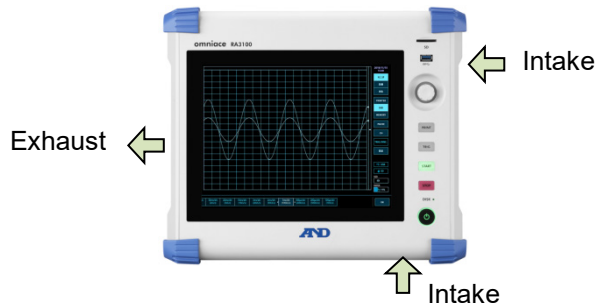

- Do not place highly combustible objects such as paper near the product.

 **WARNING**

- Module installation/removal and replacement must be performed after disconnecting all the cables connected to the module, turning off the power switch of the main unit, and disconnecting the power cable.
- Insert the module along the guide rails, and securely fix the two knurled screws with a Phillips head screwdriver. Incomplete module installation may lead to failure.
- Module disassembly is extremely dangerous. It must not be performed other than by our service engineers, as it may also lead to failure and prevent performance from being guaranteed.
- Make sure to install an empty panel on slots where no module is installed. Failure to do so may lead to failure due to the intrusion of foreign material or dust. (Empty panels are shipped together with the RA series main unit.)
- When storing the module, place it inside an anti-static bag and packaging box like those it was shipped with, as static electricity may lead to failure. This product can be stored in the range of -20 to 60°C and 20 to 85% RH (without condensation).
- The measurement category of this module is category II (CAT II) (300 V). The module cannot be used with measurement categories that exceed its specifications, such as CAT III and CAT II (600 V).
- Connect the input signal to the module after connecting the power cable of the RA series main unit where the module is installed to a 3-pole AC outlet, grounding it, and then turning on the power of the main unit.
High voltage may already be applied as the input signal. Set the measurement range of the module to the maximum and connect the input cable to the module before connecting to the signal source. Take care to not directly touch the conductors when connecting to the signal source, in order to prevent electrocution.
- A dedicated input cable for each module is provided to meet the specifications such as the measurement category and insulation with stand voltage. Use the dedicated input cable for the type of measurement.

 **CAUTION**

- When transporting the product and modules, use the package and packaging material supplied at factory shipment, or use a package and packaging material more shock-resistant than those supplied.
- We recommend a periodical calibration to maintain the accuracy of the input units. More reliable measurements are possible by calibrating the input units once a year (extra cost option).

2.1.2. Installing Optional Modules

Installation Procedure

- Step 1. Turn the power OFF.
- Step 2. Disconnect the power cable.
- Step 3. Grip the handles on both edges and insert the module straight in along the guide rails. The module type should be on the operation panel side.
- Step 4. Tighten the screws on both edges with a Phillips head screwdriver (No. 2).

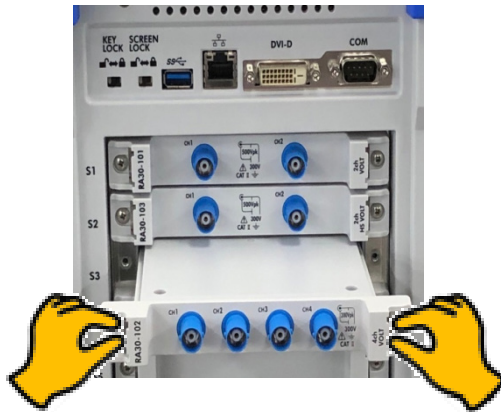

Removal Procedure

- Step 1. Turn the power OFF.
- Step 2. Remove the connected input cable.
- Step 3. Disconnect the power cable.
- Step 4. Loosen the screws on both edges with a Phillips head screwdriver.
- Step 5. Grip the handles on both edges and pull the module straight out.
- Step 6. Install an empty panel if the slot will not be used.

2.1.3. Paper Loading

The procedure for loading recording paper to the printer block is indicated below.

Load the recording paper to this product. There are two types of recording paper: paper rolls and Z-fold paper.

For information on loading Z-fold paper, see "[Loading Z-fold Paper \(Recording Paper\)](#)".

! CAUTION

- ❑ Use only the recording paper prepared exclusively for this product (YPS106 or YPS108 for paper roll and YPS112 for Z-fold paper) by our company. The quality of recording may not be guaranteed if other recording paper is used, as paper feed problems may occur or the print quality may be reduced.
- ❑ Do not use the portion of the new roll where the recording paper tip is covered with tape, as colors may not be printed normally on this area.

Raise the lever to open the printer cover.

Lever

Recording paper outlet

Printer cover

Z-fold paper inlet

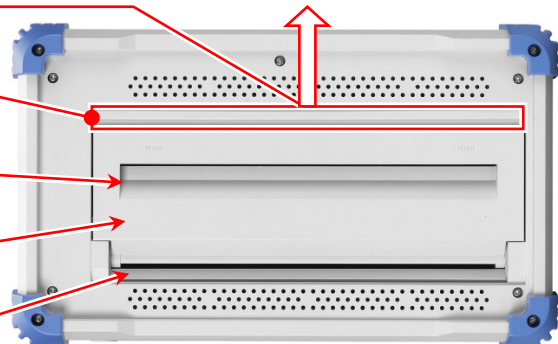

Loading Roll Paper (Recording Paper)

Step 1. Attach the paper holders to the paper roll.

Attach a paper holder to both ends of the paper roll. If there is a gap between the recording paper and the paper holder, the recording paper may not be able to be loaded or the recording position may be shifted.

If there is a gap between the recording paper and the paper holder, the recording paper may not be able to be loaded or the recording position may be shifted. When loading a partially used roll, trim the edges for ease of loading, as shown in the figure.

The inside of the roll paper is the back side and the outside is the thermal surface that is printed on.

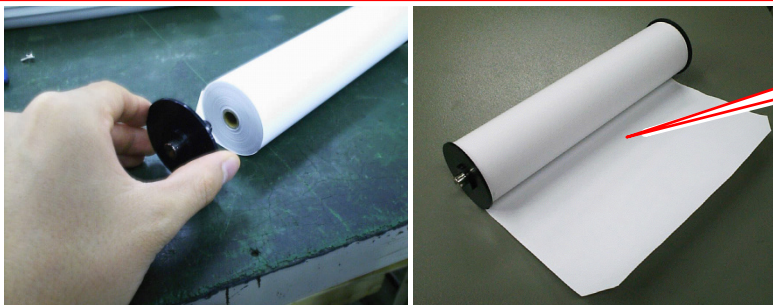

Step 2. Open the printer cover by raising the lever of the printer block.

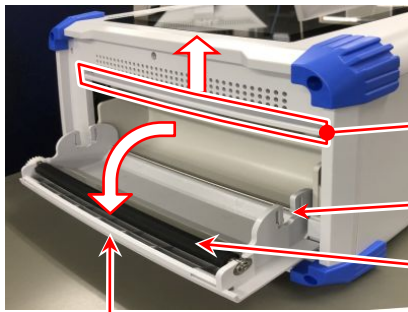

Pull the lever upwards.

Recording paper guide (the U-shaped groove)

Platen roller (black roller)

Recording paper outlet

Step 3. Load the paper following the guide of the product, and press the paper holders into the guide until a click is heard.

NOTE

- Be sure the paper roll is loaded so that the thermally sensitive side is faced toward you; if this side is faced away, the paper cannot be printed.
If the recording paper is not loaded securely, printing problems may occur or the recording paper may meander.

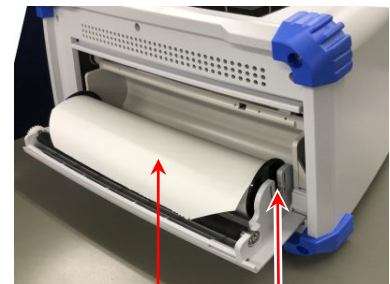

Check the winding direction carefully
Push it in so that the thermally sensitive side is faced up

Insert the paper holders into the guide of the printer block

Step 4. Feed the recording paper to the recording paper outlet. Insert the recording paper from above the platen roller of the printer block (black roller) from the recording paper outlet of the printer cover and pull it out about 10 cm.

Step 4-1. Feed the paper to the recording paper outlet from above the platen roller.

Step 4-2. Pull the recording paper out from the recording paper outlet about 10 cm.

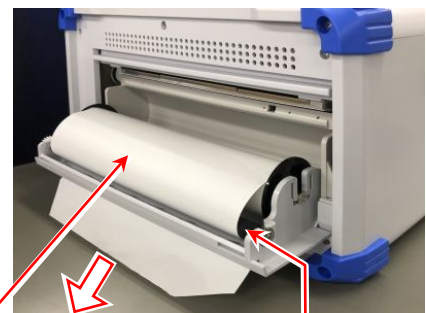

Recording paper

Platen roller

Step 5. Close the printer cover.

After pulling the paper, close the cover firmly pressing down on both sides (until a click is heard). Pull the paper out keeping it straight. When using without both sides of the paper pushed into the recording section, recording cannot be performed correctly.

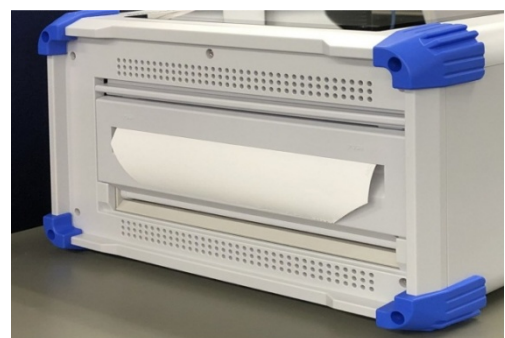

Loading Z-fold Paper (Recording Paper)

To use Z-fold paper (YPS112), a Z-fold paper case (RA30-551, sold separately) is required.

<Z-fold paper> YPS112

- Length: 200 m
- Folded width: 30 cm
- To indicate how much paper is remaining, a page number (669 to 000) is printed on each page.

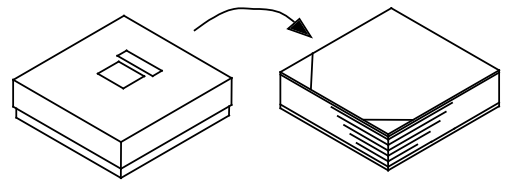

<Z-fold paper box> RA30-551

- Z-fold paper case: Approx. 3 kg
- Z-fold paper stock box: Approx. 300 g
- Z-fold paper adapter: Approx. 200 g

Z-fold paper case

Z-fold paper stock box

Z-fold paper adapter

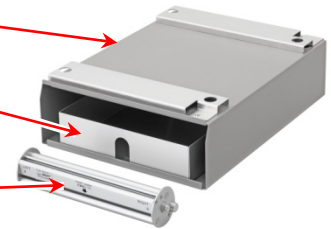

The procedures for loading the Z-fold paper are explained as follows.

Step 1. Place the product on top of the paper case.

With the paper case opening and the printer block facing the same direction, align the metal fittings of the case with the legs of this product.



Step 2. Put the paper in the case.

Step 2-1. Remove the contents from the case, open the plastic bag and take out the piece of cardboard covering the paper. Use the top cover of the case as a receptacle for the recorded paper.

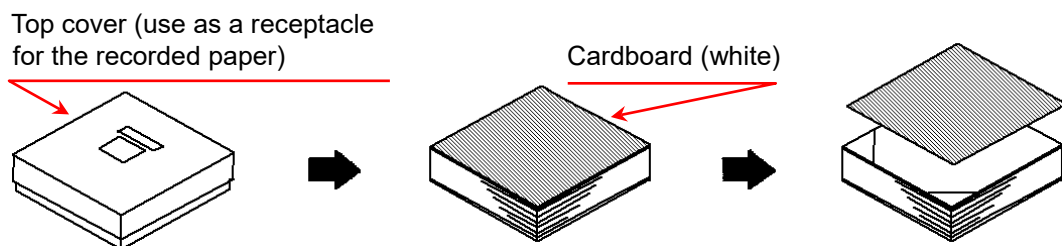

Step 2-2. Place the paper in the stock box with the thermally sensitive side (the side with blue numbers printed on the edges) facing up.

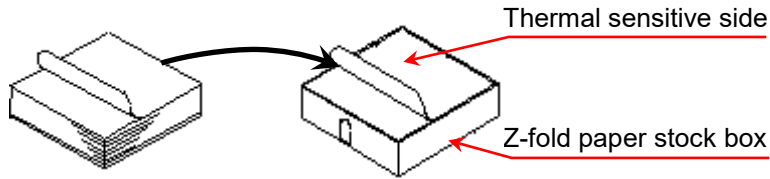

Step 2-3. Position the stock box so the thermal sensitive side of the paper is facing up and insert the box into the case opening.

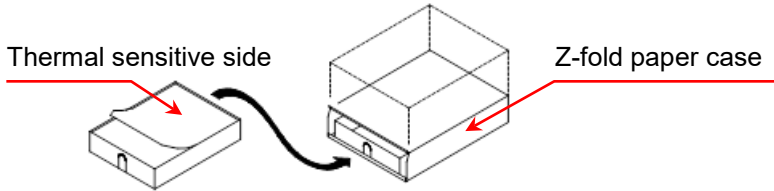

Step 3. Open the printer block by raising the lever of the printer cover. After opening the printer cover, insert the paper pulled out from the case into the opening under the printer cover.

Printer cover

Insert the paper into the opening under the printer cover

Z-fold paper

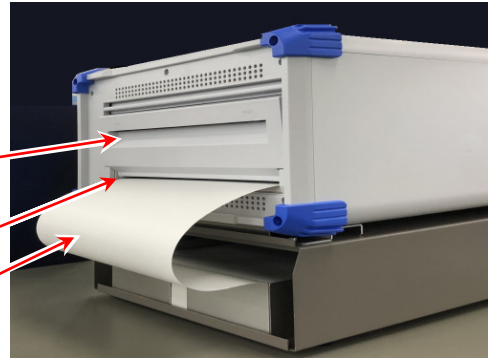

Step 4. Thread the paper through the Z-fold paper adapter. Thread the paper inserted into the opening under the printer cover through the Z-fold paper adapter as shown in the figure.

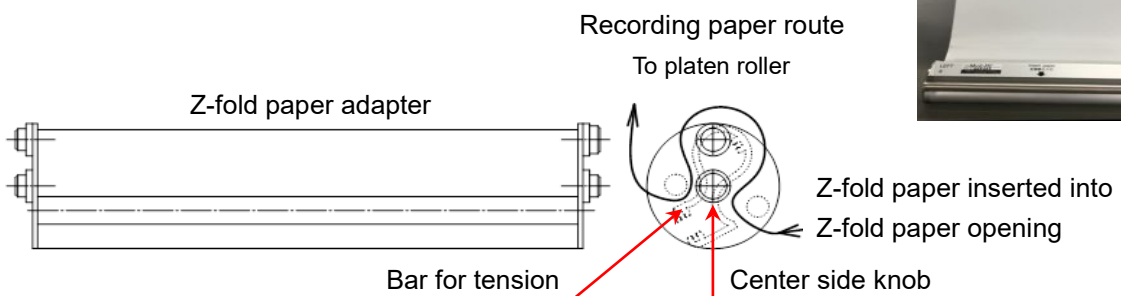

Step 5. Attach the Z-fold paper adapter to the recording paper guide of the printer cover.

Insert the Z-fold paper adapter with paper threaded into the recording paper guide (the U-shaped groove) of this product with the center knob facing down, and push it in until it clicks.

Bar for tension

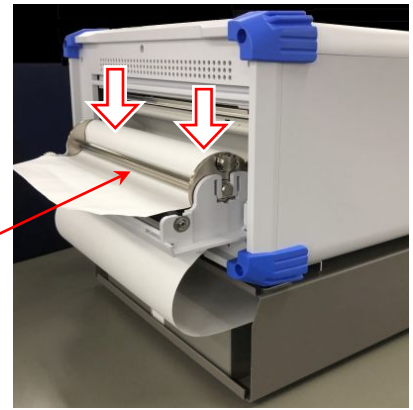

Step 6. Pull out the paper.

Pull out the paper threaded into the Z-fold paper adapter about 10 cm under the bar for tension.

Step 7. Feed the paper to the recording paper outlet.

Insert the paper threaded into the Z-fold paper adapter from above the platen roller of the printer block (black roller) from the recording paper outlet of the printer bar and pull it out about 10 cm.

Platen roller



Step 8. Close the printer cover.

When the paper has been fed through, pull it straight out so that it does not sag, and close the printer cover securely.



NOTE

- Place the cover of the box containing the paper on the printer side of this product to use as a paper receptacle. To ensure smooth paper output, fold one or two sheets into the receptacle before use. Note that although Z-fold paper usually folds automatically as it is output, some environmental conditions, such as a humid atmosphere or the setting location, may cause the paper not to fold normally.

2.2. Turning the Power On/Off

2.2.1. Connecting the AC Power Cable

Be sure to check the following points before connecting the AC power cable to this product.

- Make sure that the power supply matches the rating indicated on the rating plate attached to this product.
- Ensure amp or interface units are inserted securely.

! WARNING

- This product must be grounded before turning on the power.
- This grounding protection is for the safety of this product, as well as for that of the user and peripheral equipment.
 - If the AC power cable that comes with this product is connected to a 3-pin power outlet equipped with a protective conductor pin, the product is automatically grounded.
 - Do not use an extension cable without protective grounding.
 - Do not use this product when protective grounding cannot be performed using a power outlet that matches the supplied AC power cable.

NOTE

- AC power cable
The AC power cable that is included in this product (1KO6165-200: 125-V AC system, 2 m) is a 3-pin type which has a round pin at the center for protective grounding.

2.2.2. Turning On the Power

Step 1. Perform the check indicated below.

<Items to check before turning on the power>

- Is this product installed in a safe location?
- Is the usage environment OK?
- Is the top of the touch panel free from any writing implements or tools, etc.?

Step 2. Upon confirming that all of the above check items are fine, connect the inlet side of the AC power cable to the AC socket of this product.

Step 3. Connect the plug of the AC power cable to the power outlet.

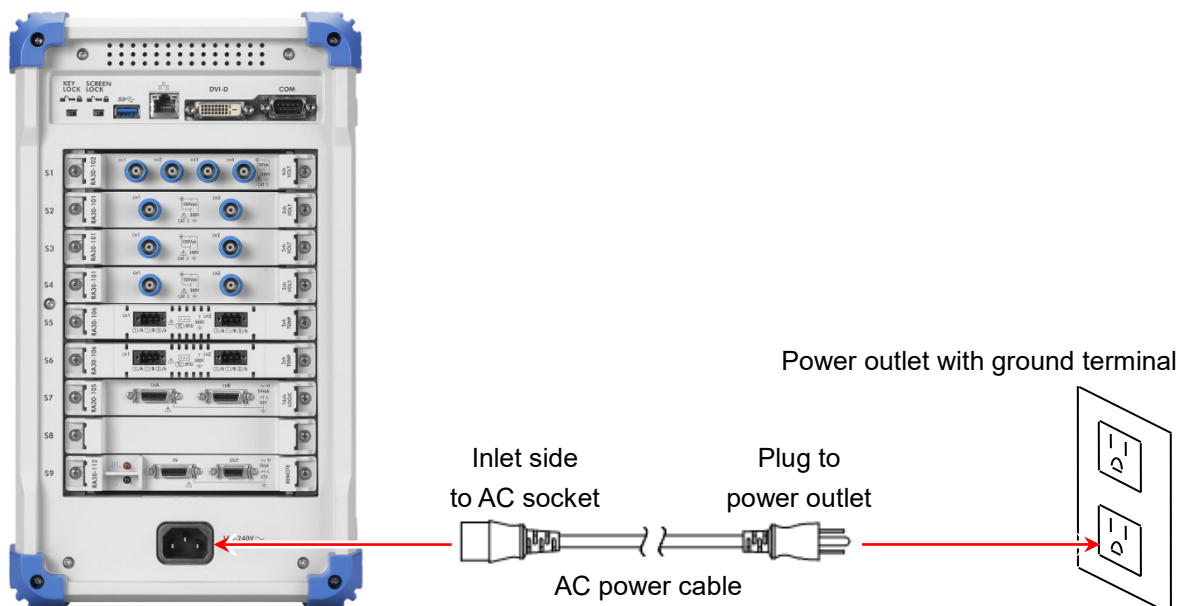

Step 4. Turn the power switch of the product on.
When the **Power** switch on the operation panel of the product is turned on, the green LED lights up and the power turns on.

NOTE

- Standby current flows to this product when the AC power cable is connected to the power outlet.
Remove the power cable when the product will not be used for an extended period of time.

Power switch

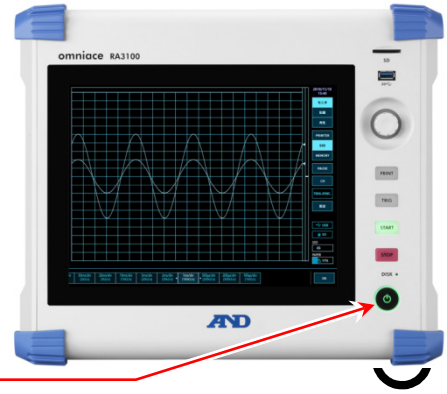

2.2.3. Confirming Normal Startup

The monitor screen of the RA3100 is displayed about one minute after turning the power on.

NOTE

- Do not touch the touch panel until the waveform monitor is displayed. Doing so may lead to erroneous operations.
- Immediately after purchase or initializing the main unit, measurement is turned off for all channels and no waveform is displayed.

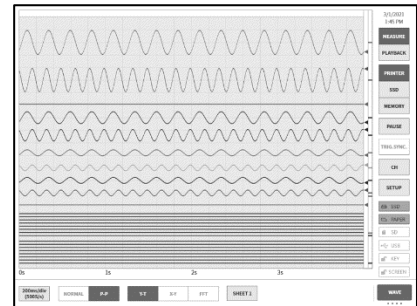

2.2.4. Setup Date and Time

The current time is displayed on the top right of the screen, but if it differs greatly from the actual time, the time can be adjusted.



See "8.2.5. Environment Setup".

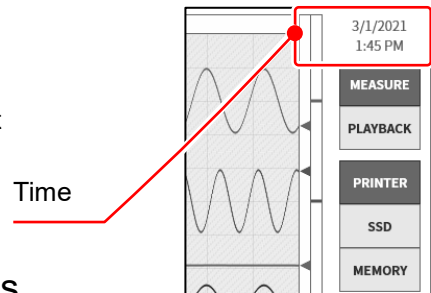

Time

2.2.5. Preparing for More Precise Measurements

Warm up the product for about 60 minutes after turning on the power in order to perform more precise measurements.

After the warm up is complete, perform "Zero adjust" of the input modules.



See "4. Configuring Measurement". This completes the preparations for measurement.

2.2.6. Turning Off the Power

Step 1. When the **Power** key on the operation panel is pressed while the power is on, the shutdown process starts and the [Shutdown] dialog box indicated below is displayed on the center of the screen. Tap the **OK** key to shutdown the product. Tap the **Cancel** key to continue without turning off the power.

If the **Power** key is pressed again while the [Shutdown] dialog box is displayed, the product automatically shuts down.

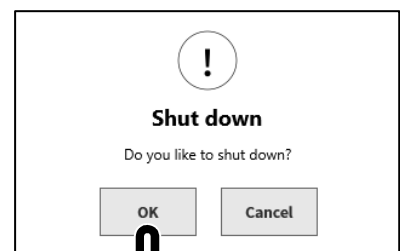









⚠ CAUTION

- Make sure to shutdown the product to turn off the power, as directly removing the power cable from the power outlet without shutting down can damage the files in the internal storage.

3. Flow of Measurement

This product records and play back input signals following the procedures described below.

3.1. Flow of Measurement

Perform the check before applying power and turn on the power.	"Chapter 2" 	Confirm that this product has been set in a safe place, and that all the accessories are properly attached.
Lower the measurement range, and connect the signal.	"Chapter 4" 	Note that applying a voltage greater than the maximum allowable input voltage specified by the sensitivity setting of each input module may cause damage to the main unit or internal components.
Set the input channel while viewing the monitor waveform.	"Chapter 4.2" 	Setup the input channel settings to the conditions for recording. Set the measurement range, filter, display position, display range, and the sampling speed in the time axis direction.
Select the recording method.	"Chapter 4.3" 	Select to record to recording paper only or to both a file and recording paper.
Set the recording device and sample speed according to the target for measurement.	"Chapter 4.4" 	<p>Set the sampling speed and the recording device to save, as well as the recording time, speed of input signal changes (frequency), and whether to perform analysis after recording, etc.</p> <p>Printer : Low-speed long-term measurement with only the waveform recorded</p> <p>SSD : Medium-speed long-term measurement for various uses</p> <p>Memory : High-speed enlarged display of transient phenomena and abrupt phenomena</p>
Set the triggers.	"Chapter 5" 	Set the triggers for starting recording.
Start and end recording.	"Chapter 6" 	Press the START key on the operation panel to start measurement and record the specified time and data count, and press the STOP key to end measurement.
Playback and analysis.	"Chapter 7" 	Use the PLAYBACK key on the side menu to playback recorded data, the DATA key on the control bar to select data, and the X-Y key and FFT key on the control bar to perform data analysis.

4. Configuring Measurement

4.1. Reducing the Input Sensitivity and Connecting the Input Cable

- Step 1. The input signal can be displayed and checked in real-time by switching the **[MEASURE/PLAYBACK]** key on the **side menu** to **[MEASURE]**.
- Step 2. Tap the **[CH]** key on the **side menu** to display the channel setup sub menu.
- Step 3. When the **[Meas. range]** key is tapped in the channel setup sub menu, the border of the key turns orange. The area around the rotary knob turns blue, and the rotary knob can be used to change the setting.
- Step 4. Turn the rotary knob counterclockwise to set the minimum input sensitivity. (Turning the rotary knob clockwise increases the sensitivity.)

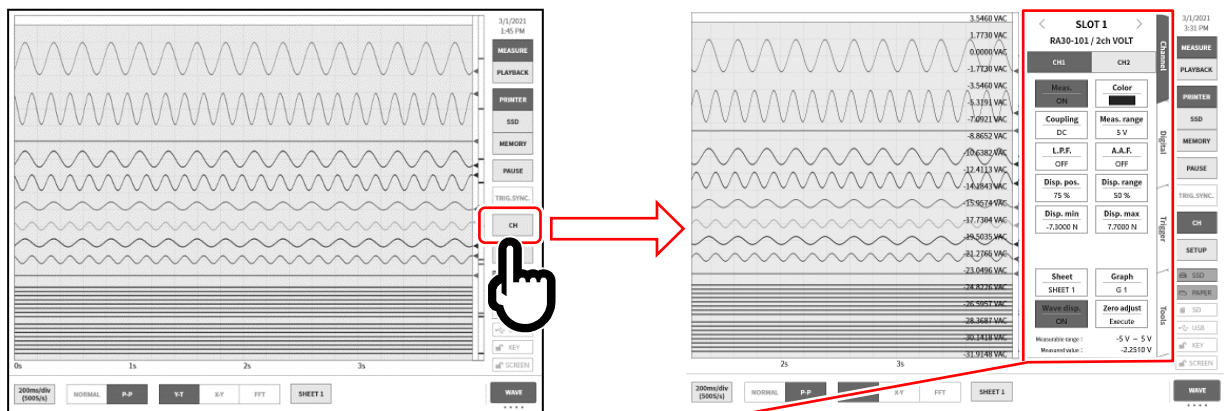

Channel setup sub menu

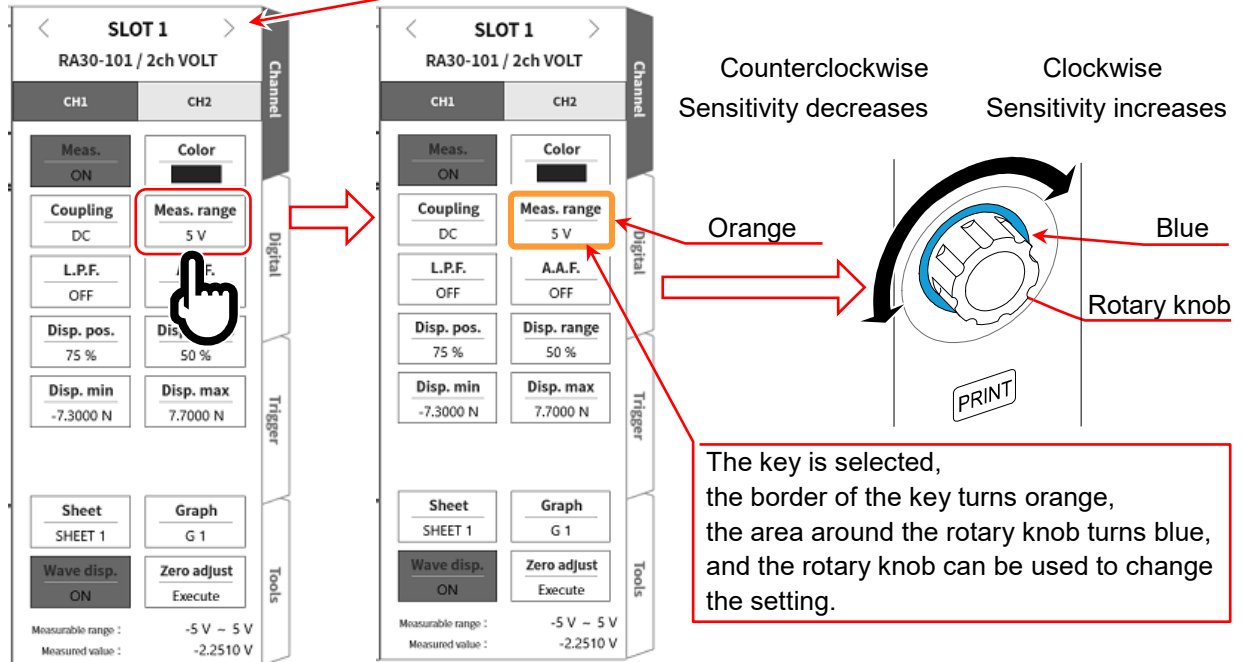

4.Configuring Measurement – 4.1.Reducing the Input Sensitivity and Connecting the Input Cable

Step 5. Tap the **【CHx】** tab in the channel setup sub menu to change the displayed channel.

Step 6. To change the display slot of the input module, swipe the channel setup sub menu left or right, or tap the **【<】** or **【>】** key on the top.

Step 7. Next, connect the insulation BNC cable (standard) to the BNC terminal of the input module.

! WARNING

- Do not input voltages that exceed the maximum allowed input voltage or withstand voltage to an input module.

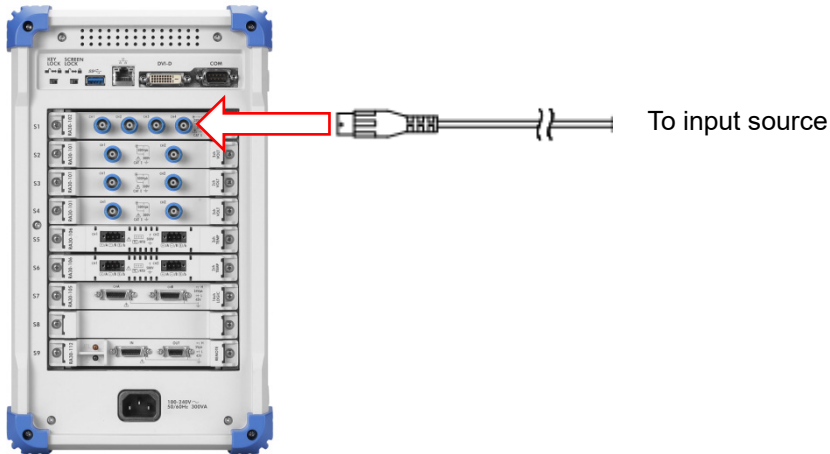

4.2. Setting the Input Channel

4.2.1. Channel setup sub menu (for RA30-101)

(1) Slot number, input module type

(2) Change slot: You can change the display slot by swiping this sub menu left or right or tapping the left [**<**] and right [**>**] key.

(3) Select channel:
Select the channel in the slot.

(4) Meas. ON/OFF
ON: Measure and record the input signal.

(5) Color: Change the display color of the waveform monitor.

(6) Coupling: Switch the input signal coupling in the order DC → GND → AC.

(7) Meas. range:
Change the measurement range of the input channel. When this key is tapped, the rotary knob is enabled (the LED lights up) and the range can be selected by turning the knob.

(8) L.P.F.: Change the low-pass filter of the input channel. When this key is tapped, the rotary knob is enabled (the LED lights up) and the filter can be selected by turning the knob.

(9) A.A.F.: Turns the anti-aliasing filter of the input channel on or off.

(10) Disp. pos.: Specify the position of the waveform monitor to display the specified range of the waveform display area. Specified as a percentage indicating the center position of the display range from the bottom of the graph when the full range of each graph is 100%.

(11) Disp. range: Specifies the display width in the amplitude direction of each graph. Specified (by tapping the key and turning the knob) as the percentage of the display width with the full range of each graph at 100%.
Example) When 50% is set, the waveform display is 10 div of the total width of 20 div.

(12) Disp. min: Set (by tapping the key and turning the knob) the display lower limit value (scale value) of the bottom of the display range.

(13) Disp. max: Set (by tapping the key and turning the knob) the display upper limit value (scale value) of the top of the display range.

(14) Sheet: Set the monitor display/printer print sheet of the set channel.

(15) Graph: Set the graph.
When this key is tapped, the rotary knob is enabled (the LED lights up) and the graph can be changed by turning the knob.

(16) Waveform display area:
When enabled, the waveform is displayed. When disabled, the waveform is not displayed.

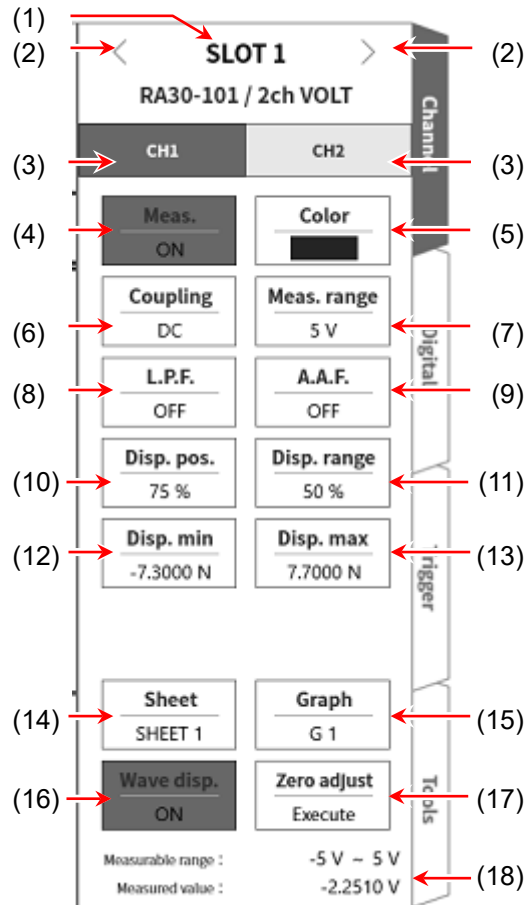

- (17) Zero adjust: Cancels the input offset of the input channel. Execute zero cancellation to perform more accurate measurement.
- (18) Available measurement range/measurement value:
Displays the current available measurement range and measurement value.

4.2.2. Setup the input channels

The input waveform is displayed on the monitor when a signal is connected to the input module.

The overall procedure for setting the input channel is indicated below. See the following for details on each step.

- Step 1. Set coupling. (When the input module is a voltage module)
- Step 2. Set Meas. range according to the target for measurement.
- Step 3. Set the input filter.
- Step 4. Set the waveform division.
- Step 5. Set the display range and display position.
- Step 6. Set the display minimum and display maximum.
- Step 7. Execute zero adjust.

Description of Step 1 (setting coupling)

Select the input coupling using the **【Coupling】** key in the channel setup sub menu.

Tap the **【Coupling】** key and turn the rotary knob to change the setting in the order DC → GND → AC.

Coupling	Contents
DC	Enables measurement of the actual input signal, including the DC and AC component.
AC	Measures the AC component of the input signal only. Set this when you want to measure only the amplitude of an AC signal, as it cancels the DC offset of the signal.
GND	Connects the channel input to GND without connecting the input signal inside the channel. Enables the input GND level to be checked with waveform monitoring or printer recording.

Description of Step 2 (setting the measurement range)

The input sensitivity can be changed in **【Meas. range】** in the channel setup sub menu.

The value displayed for the measurement range (RANGE) indicates the input (measurement) maximum value and corresponds to 10 div on the waveform monitor. When the display position is 50%, the full measurement range of \pm RANGE (20 div) is displayed.

When the **【Meas. range】** key is tapped in the channel setup sub menu, the border turns orange, the area around the rotary knob turns blue, and the rotary knob can be changed.

Turn the rotary knob counterclockwise to reduce the sensitivity and clockwise to increase the sensitivity.

The setting values of the measurement range differ according to the type of input module.

When the input exceeds the measurement range, "OVER RANGE" is displayed on the bottom right of the screen, and the main unit emits a warning beep. Reduce the sensitivity with the measurement range so that the input signal does not exceed the range. To emit a warning beep, enable the buzzer setting. See "8.2.5 Environment Setup".

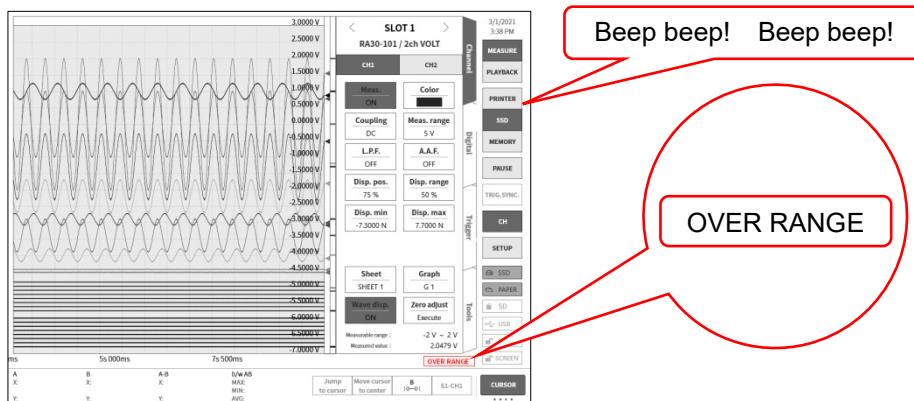

Description of Step 3 (setting the filter) (procedure on page 39)

Set the filter of the selected channel.

This cuts out unnecessary frequency components and noise. As the filter differs according to the input module type, set the filter according to the characteristics of the input signal and measurement.

Low-pass filter (L.P.F.)

A gently sloping attenuation filter. Set the cutoff frequency in consideration of the frequency of the input signal.

Anti-aliasing filter (A.A.F.)

A steeply sloping attenuation low-pass filter. Enable this filter to automatically set the filter so that aliasing of the A/D data does not occur due to the sampling speed.

Description of Step 4 (setting graph division)

(procedure on page 39)

"Graph" refers to the area in the Y-T waveform monitor where a channel waveform can be displayed. The graph area can be divided into 1 to 18 graphs.

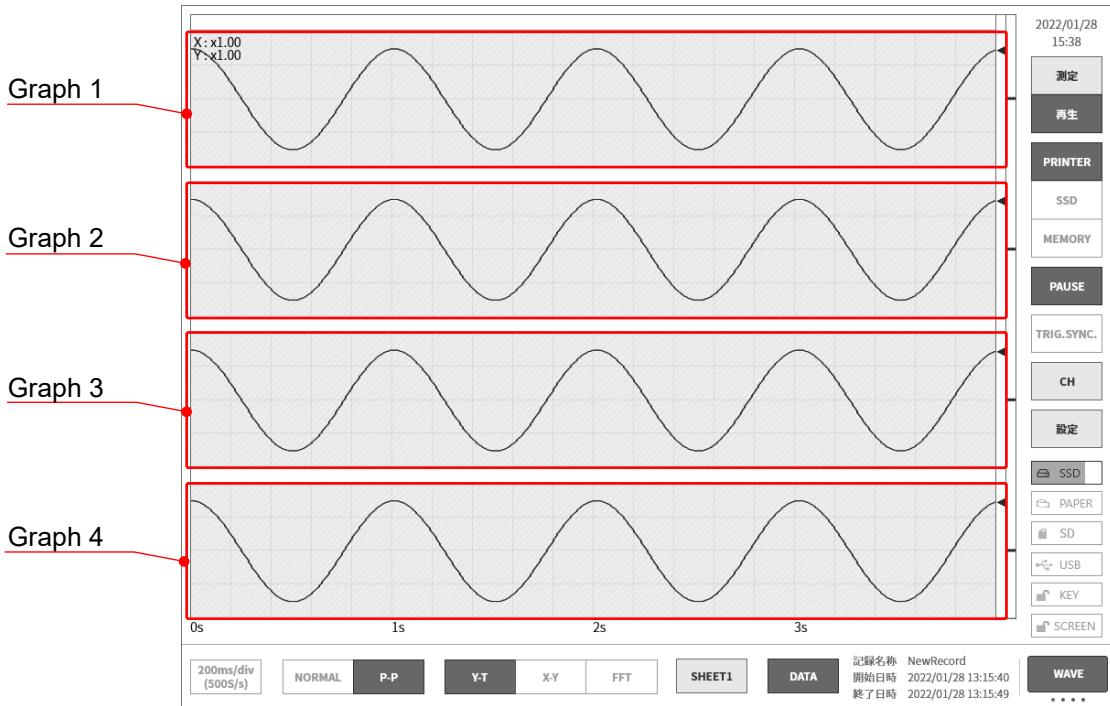
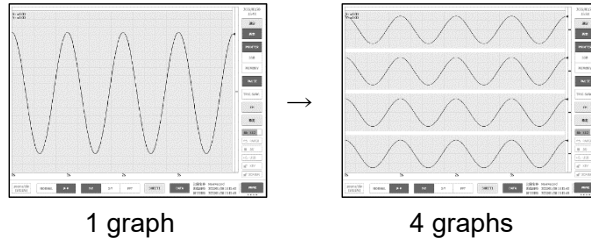

Description of Step 5 (setting the display range and display position (waveform display area))

(procedure on page 39)

When displaying multiple channels, it may be difficult to recognize them because the waveforms overlap. Reducing the input sensitivity in the measurement range decreases the amplitude and changes the display position, which can stop the waveforms from overlapping and make them easier to recognize, but this also reduces the resolution of the data. The display range and display position settings can be used to change the display scale and display position of the waveform amplitude direction without reducing the resolution of the data of the channel being displayed.

Disp. range: The display width in the amplitude direction of the waveform display area in the graph specified as the percentage of the display width when the full range of each graph in the vertical direction is 100%.

Example) When 40% is set, the waveform display is reduced to 8 div of the total width of 20 div.

Disp. pos.: Specify the position of the graph to display the specified range of the waveform display area. Specified as a percentage indicating the center position of the display range from the bottom of the graph when the full range of each graph in the vertical direction is 100%.

When the **【Disp. range】** key or **【Disp. pos.】** key is tapped, the rotary knob is enabled and the setting value can be changed by turning the knob. The key can also be pressed and held to display numeric keys for directly entering values.

Relationship between the display range and display position of the input channel

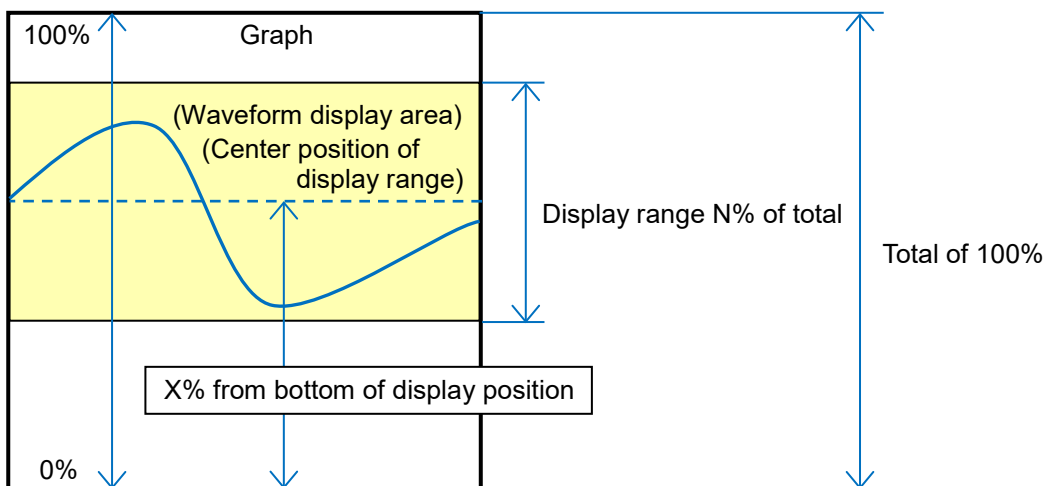

Description of Step 6 (setting the display maximum and display minimum (waveform display scale))

(procedure on page 39)

If the amplitude of the input signal is smaller than the set range, the signal change may be hard to recognize.

In this case, you can change the scale of the upper limit value and lower limit value for the display range to enlarge the amplitude of the displayed signal.

Disp. max: Set the display upper limit value of the top of the display range.

Disp. min: Set the display lower limit value of the bottom of the display range.

When the **【Disp. max】** or **【Disp. min】** key is tapped, the rotary knob is enabled and the setting value can be changed by turning the knob. The key can also be pressed and held to display numeric keys for directly entering values.

Relationship between the display maximum and display minimum of the input channel

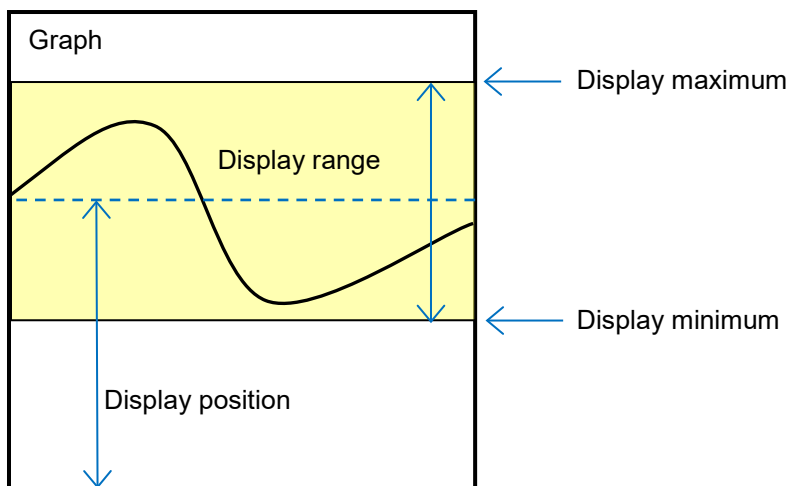

NOTE

- If the sensitivity of the measurement range is increased to enlarge the amplitude, the amplitude of the input signal will only become a little bigger and the range may be exceeded or the input maximum value may not be able to be read, etc.
If the display is enlarged by changing the scale, the recorded data is recorded until the value set in the measurement range, and the display can only be enlarged.

Description of Step 7 (zero adjust)

(procedure on page 39)

After turning on the power, the internal temperature of the product will rise as time elapses, and cause temperature drift inside the input module, which leads to errors in the measurement data.

Execute zero adjust to cancel these errors.

In order to perform measurement with few errors, let the product warm up for 60 minutes after turning on the power, then tap the **【Zero adjust】** key in the channel setup sub menu to cancel the input drift.

This function may not be available, depending on the type of input module.

NOTE

- This function is for canceling internal offset and drift, and does not cancel the offset of the input signal.

4.3. Selecting the Recording Method

Select the recording method, depending on whether to save the measurement data to a file.

4.3.1. Recording to Recording Paper Only

Perform "pen recording" to record to recording paper only, without saving a file.

See "[6.2.2. Pen Recording](#)" and "[6.2.3. Setup and Printing Annotations](#)".

Recording to a File and Recording Paper

Save the measurement data to a file and print it to recording paper.

This function provides the following.

- Nine types of recording modes (start trigger, interval, etc.)
- Simultaneous recording to three recording devices (printer, SSD, and memory)
- Enabling/disabling of real-time waveform printing
- Memory recording via memory triggers at 18 trigger sources
- Starting recording via start triggers at arbitrary timing

See "[6.3 Starting and Ending Recording](#)".

4.4. Recording Setup

4.4.1. Setup the Sampling Speed

An image of the waveform recorded on the selected recording device (PRINTER, SSD, or MEMORY) is displayed on the waveform monitor.

The sampling speed of the image waveform recorded on the selected recording device is displayed on the left edge of the control bar.

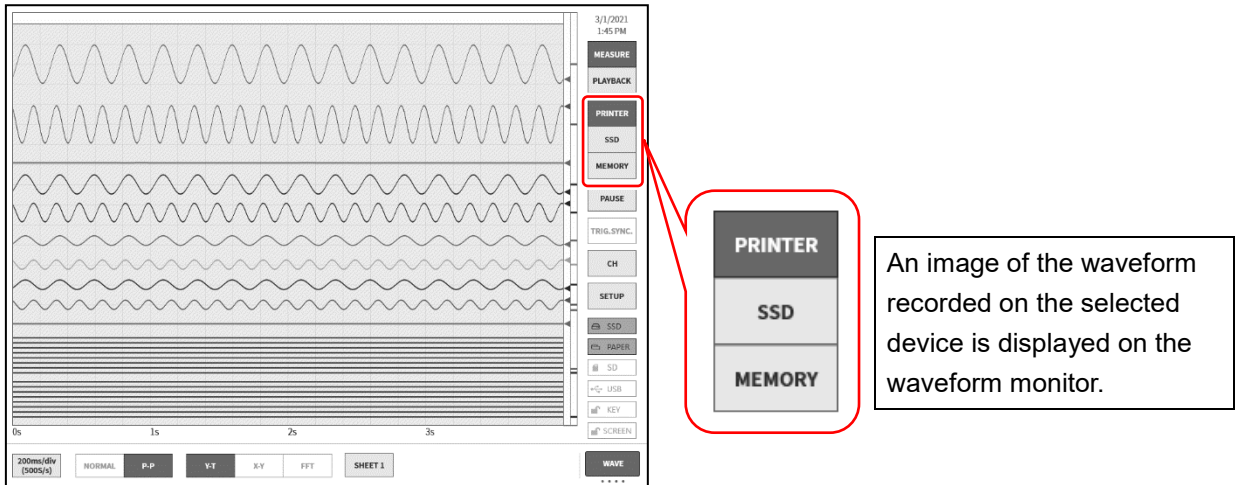

Tap to display the selectable sampling speed table.

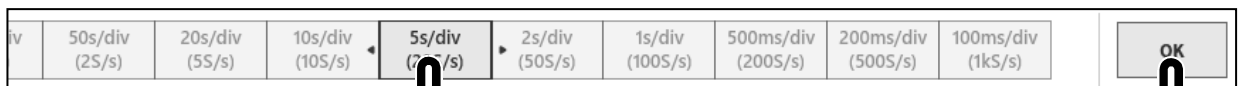

Tap the sampling speed to display the waveform sampled at that speed.

Drag the table to the left or right to display the hidden speed table.

When the sampling speed is decided, tap **OK** on the right edge to close the table.

4.4.2. Sampling Speed of Recording Device

There are three types of recording device (PRINTER, SSD, and MEMORY).

The sampling speed setting range and characteristics of each device are indicated below.

PRINTER	Setting range	100 ms/div (1 kS/s) to 10 min/div (10 S/min), EXT. (external sampling)
	Characteristics	Records the waveform to the long-term printer at low speed. Because the waveform is directly recorded to the recording paper, it is easy to confirm the input signal and suitable for viewing long-term trends. The recorded data is internally sampled at 20 MS/s and the waveform is recorded with P-P data, which enables recording of high-speed signals without loss.
SSD	Setting range	100 μ s/div (1 MS/s) to 10 min/div (10 S/min), EXT. (external sampling)
	Characteristics	Records the long-term data to the SSD at medium speed. NORMAL or P-P can be selected for the recorded data. When recorded with NORMAL data, FFT or X-Y analysis is possible in addition to standard Y-T waveforms. For P-P data, the data can be recorded for extended periods at a speed where the printer cannot record.
MEMORY	Setting range	5 μ s/div (20 MS/s) to 10 min/div (10 S/min)
	Characteristics	Records the data to the internal memory with high-speed sampling. The data is recorded when the trigger conditions set in advance are detected, and recording automatically ends when the specified sample count has been recorded. Only NORMAL can be selected for the recorded data. This is suitable for sudden input signals, rise/fall time, and measurement of the delay between signals.



For information on NORMAL/P-P sampling, see "[10.1. Sampling Data Formats](#)". For a comparison of the printer sampling speed and chart speed (mm/s) of previous products, see "[10.2.3. Relationship between Sampling Speed and Chart Speed](#)".

5. Trigger Setup

5.1. Trigger Types

This product has two types of triggers: Memory triggers for memory recording and Start triggers for starting recording.

5.2. Memory trigger

Memory trigger is a signal for enabling memory recording, and is occurred when the trigger conditions of the channel specified in the trigger source are established.

When a trigger is detected, memory recording is performed with the data count set in the pre-trigger and memory block size, which represents a single recording operation. When the number of blocks to record is set to a multiple number, recording starts for the next block when one block has finished recording.

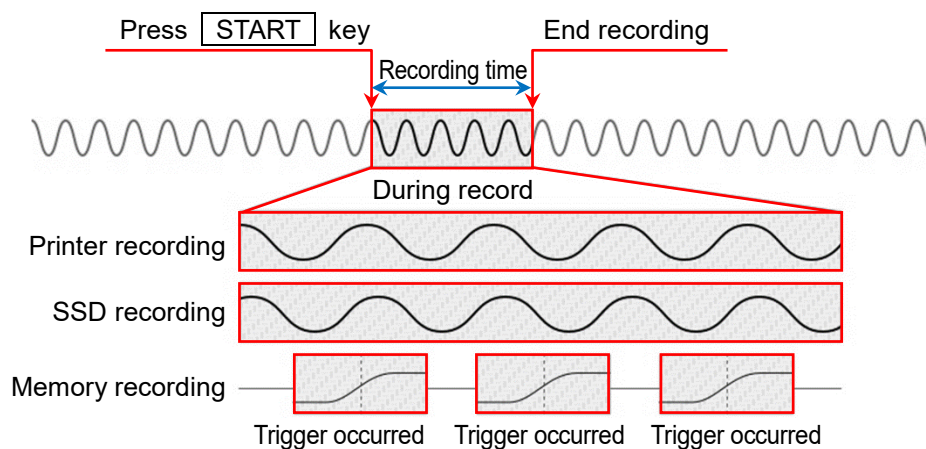

5.2.1. Memory Trigger Setup

Step 1. Tap the **[CH]** key on the [side menu](#) to display the channel setup sub menu.

Step 2. Tap the **[Trigger]** tab on the bottom right of the channel setup sub menu to display the trigger setup screen.

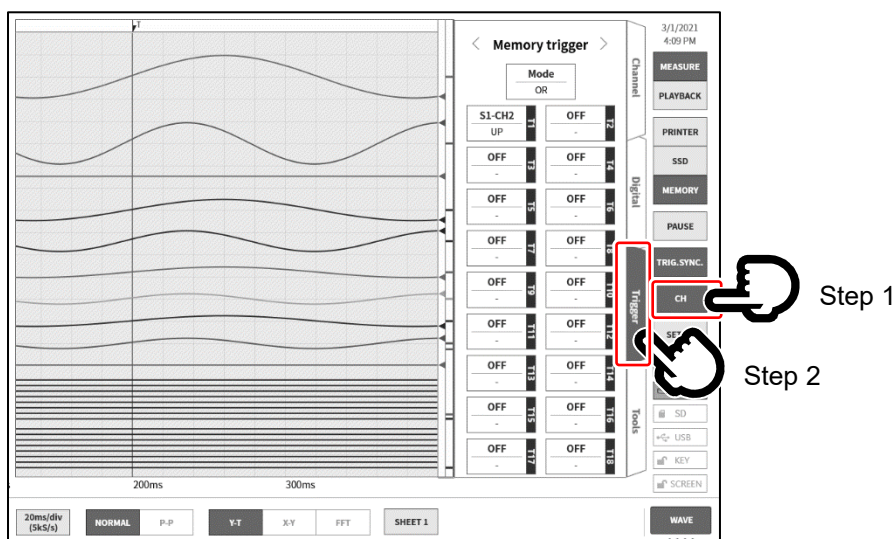

Step 3. Up to 18 trigger sources (【T1】 to 【T18】) can be set.

Tap the number of the trigger source to set to display the details screen.

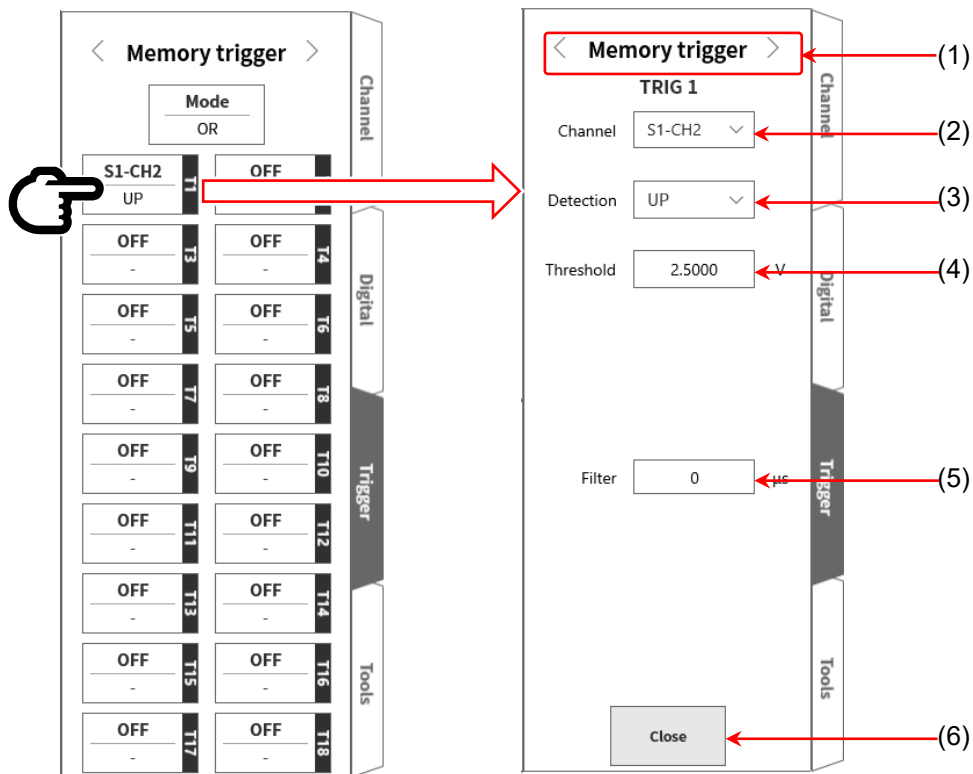

(1) Trigger menu selection:

Switches between the Memory trigger, Start trigger, or Memory block menu

(2) Channel: Selects the TRIGn source channel.

(3) Detection: Selects UP, DOWN, INTO WIN, or OUT WIN for the polarity of the trigger signal.
 UP The trigger is detected when the value exceeds the trigger level (threshold).
 DOWN The trigger is detected when the value is below the trigger level (threshold).
 INTO WIN The trigger is detected when the value enters the range of the upper limit value or lower limit value of the trigger level.
 OUT WIN The trigger is detected when the value leaves the range of the upper limit value or lower limit value of the trigger level.

(4) Threshold: Sets the trigger level (threshold).

For INTO WIN / OUT WIN, there are two settings: the upper threshold and lower threshold.

(5) Filter: Sets the filter time for noise removal.

(6) Close: Ends the setting operation and returns to the trigger list.

CAUTION

- The trigger level is a value relative to the set measurement range. The value also changes when the measurement range is changed.
 (Example) When the trigger level is set to 10 mV when the range is 100 mV, and then the measurement range is changed to 200 mV, the trigger level is changed to 20 mV.

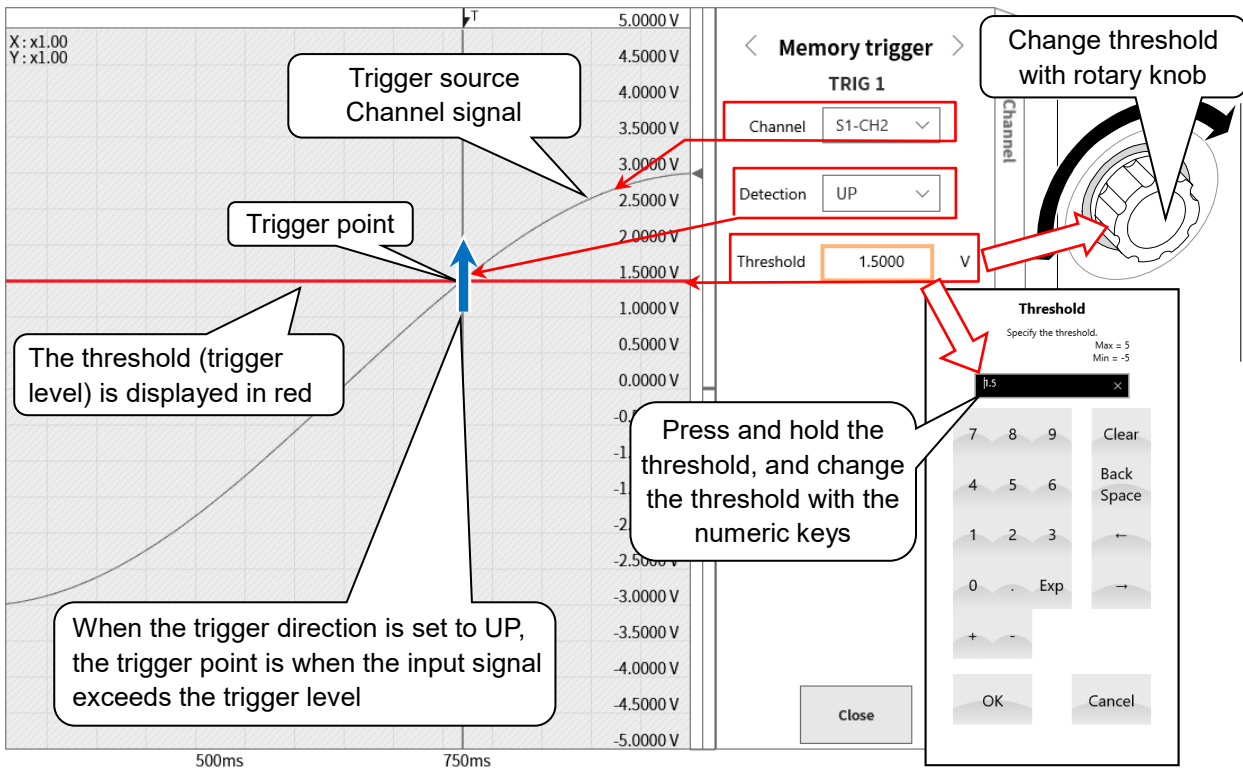

Description of trigger source (3) Detection and (4) Threshold (Settings on page 48)

- When the OR/AND trigger is used: (3) Trigger detection when the UP/DOWN trigger is selected for detection.

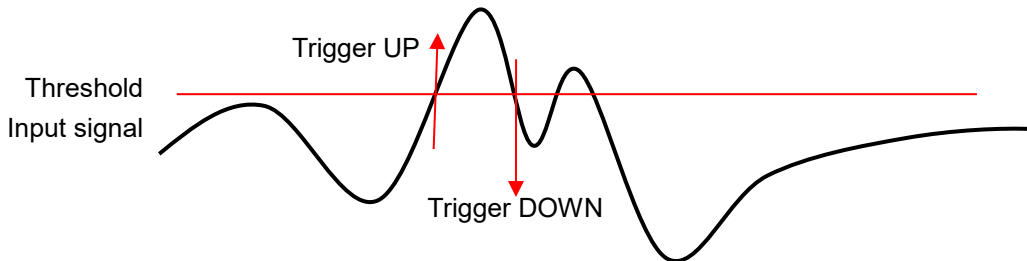

- When the window trigger is used: (3) Trigger detection when the INTO WIN / OUT WIN trigger is selected for detection.

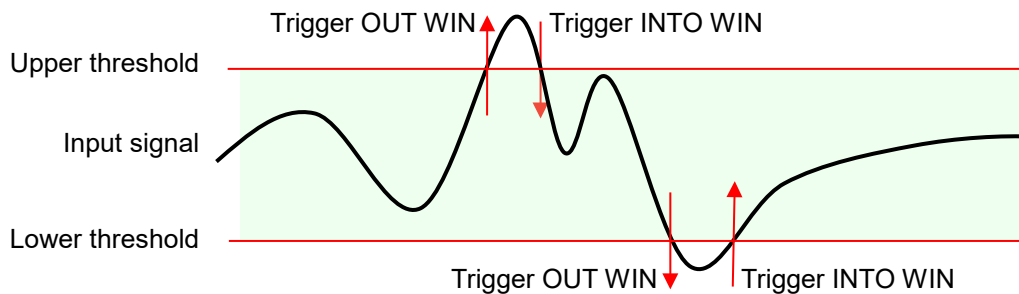

Description of trigger source (5) Filter

(Setting on page 48)

□ Trigger filter

The trigger filter function ensures that a trigger is detected when the trigger conditions are met for a specified period of time, in order to prevent erroneous trigger detection due to noise or chattering in the signal near the trigger level.

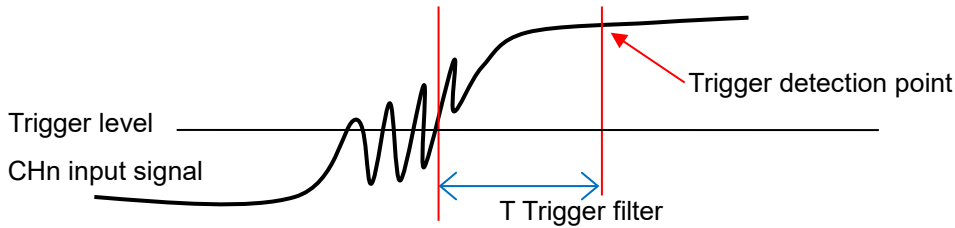

5.3. Pre-Trigger

When performing memory recording, a pre-trigger can be set to adjust the recording length before and after the trigger detection point in the memory block.

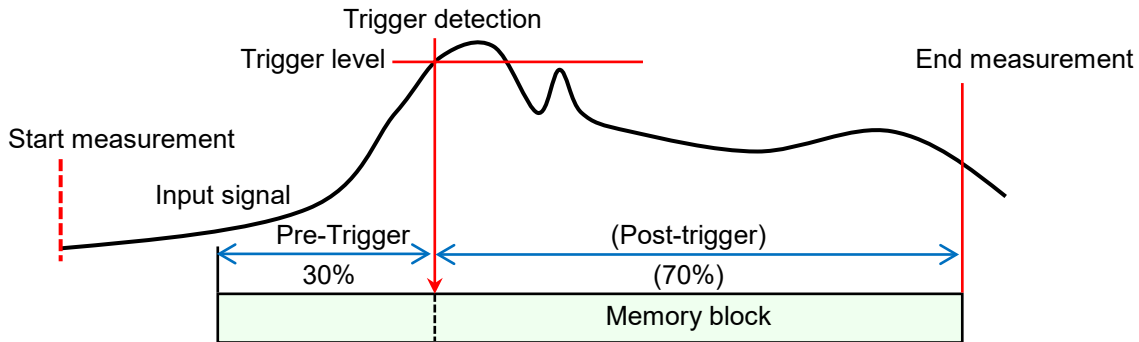

5.3.1. Pre-Trigger Setup

- Tap the **【SETUP】** key on the side menu to display the [setup menu](#).
- Tap the **【Recording】** tab in the recording setup to display the recording setup screen. The recording device settings are displayed below the recording setup.
- Tap **【Pre-Trigger】** on the right of memory recording to set the pre-trigger.

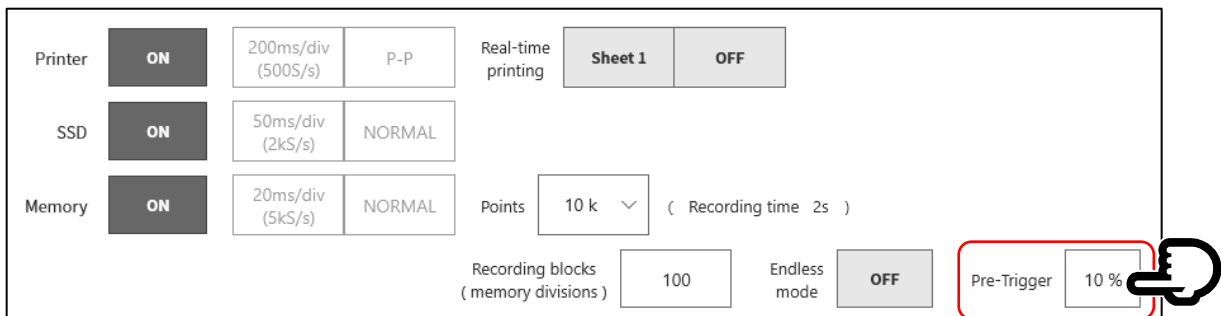

5.4. Start Trigger

The start trigger function starts recording when the trigger conditions are established for the channel specified in the trigger source. Press the **START** key on the operation panel to put the product in the standby state.

Printer recording, SSD recording, and memory recording start when the start trigger is detected.

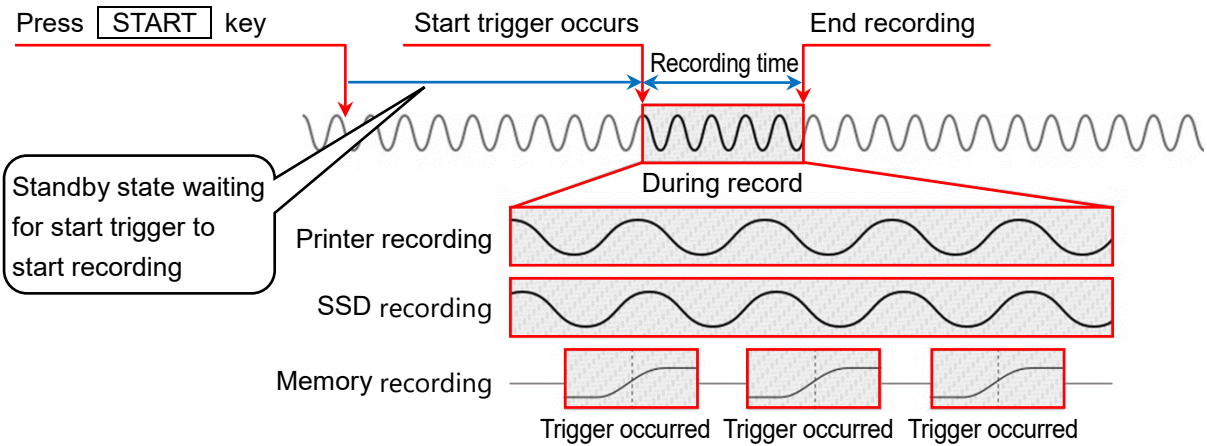

5.4.1. Start Trigger Setup

Step 1. Tap the **CH** key on the [side menu](#) to display the channel setup sub menu.

Step 2. Tap the **Trigger** tab on the bottom right of the sub menu to display the trigger setup screen.

Step 3. Tap the **trigger menu selection** on the top of the trigger setup screen (1) to display [Start trigger].

(1) Trigger menu selection: Switches the menu.

(2) Channel: Selects the start trigger source channel.

(3) Detection: Selects UP, DOWN, INTO WIN, or OUT WIN for the polarity of the trigger signal.

(4) Threshold: Sets the trigger level (threshold).

(5) Filter: Sets the filter time for noise removal.

The setup and operations of (1) to (5) are the same as the memory trigger on page 48.

6. Measuring Input Signals

6.1. State Transition of Main Unit Operation

This product is divided into three states according to the operation state: measure, record, and playback.

The **PRINT** key can also be pressed in the measurement state to perform pen recording (real-time waveform printing). The **START** key can also be pressed in the measure state to perform printer recording, SSD recording, and memory recording.

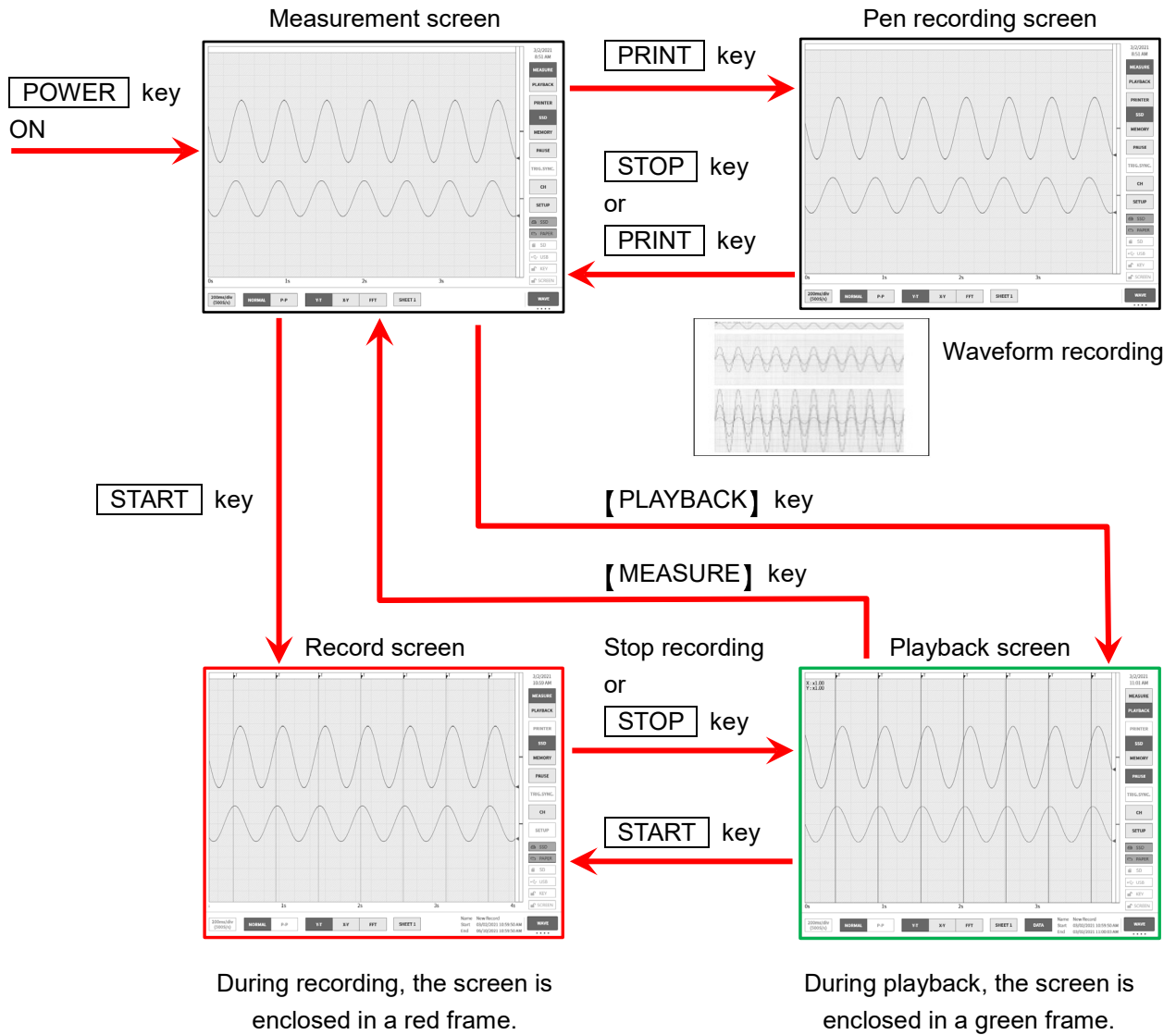

6.2. Monitor Display and Pen Recording

6.2.1. Monitor Display Function

Tap the recording device selection in the **side menu** to display the image waveform recorded on the selected device on the waveform monitor.

Printer recording

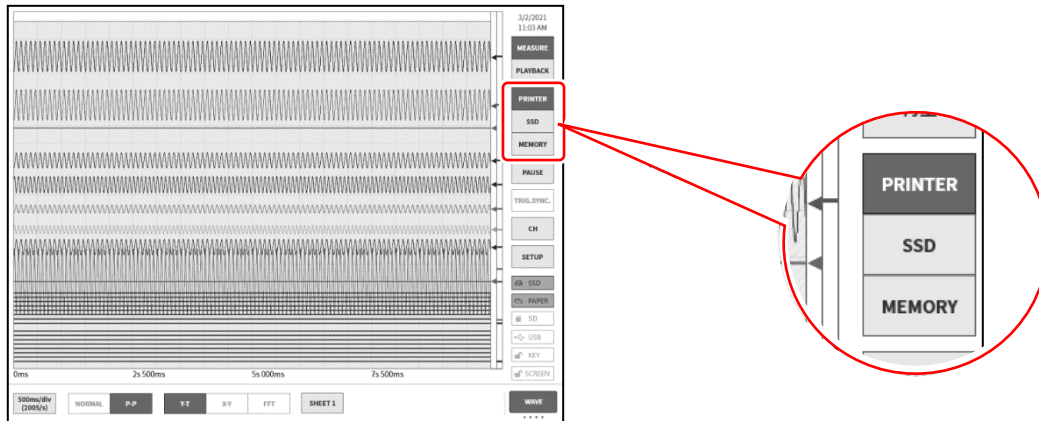

SSD recording

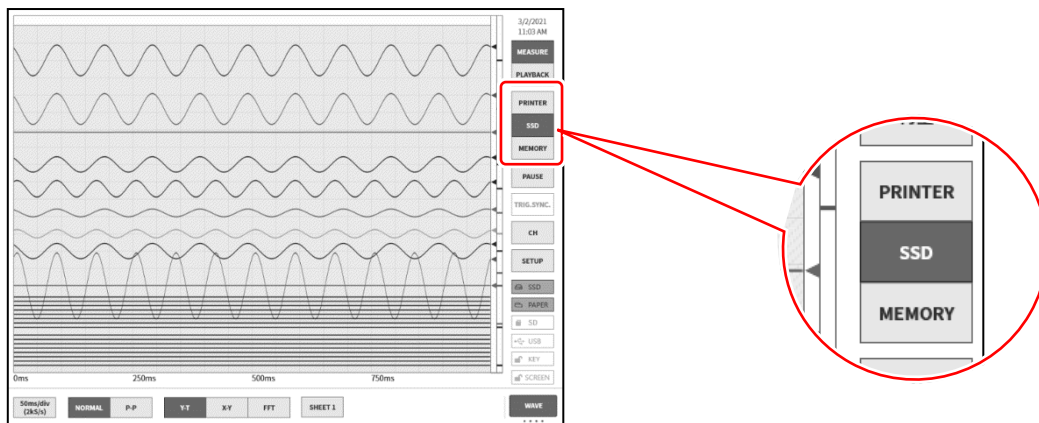

Memory recording

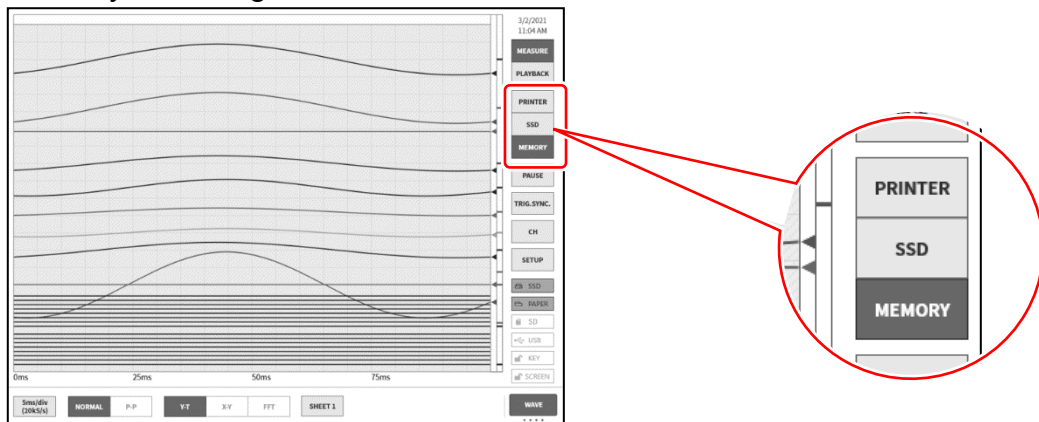

Pausing

Tap the **【PAUSE】** key on the waveform monitor to stop the monitor.

In this state, you can pinch in (reduce) or pinch out (expand) the waveform on the waveform monitor.

You can also use one finger to drag the screen up, down, left, or right to move the display area.

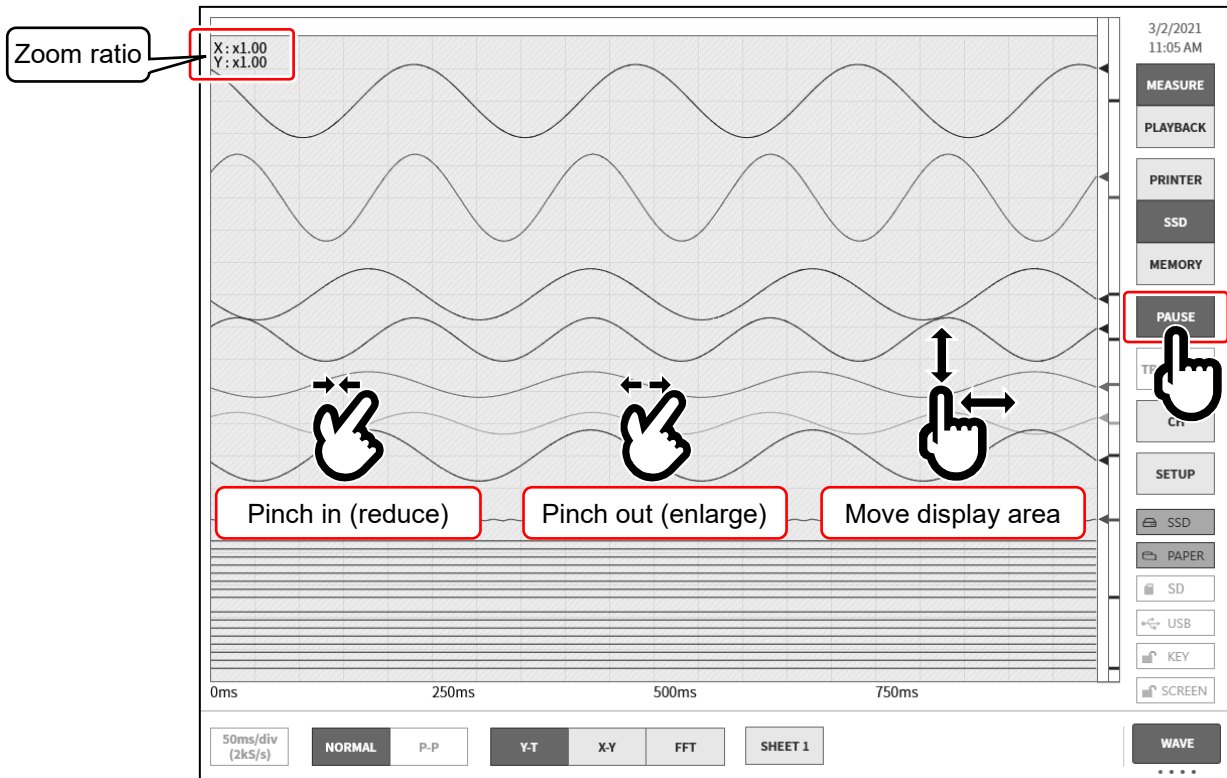

Trigger Synchronization

When the recording device is set to **【MEMORY】**, a trigger is set, and **【TRIG.SYNC.】** is enabled, the latest waveform is displayed with the displayed waveform synchronized to trigger detection.

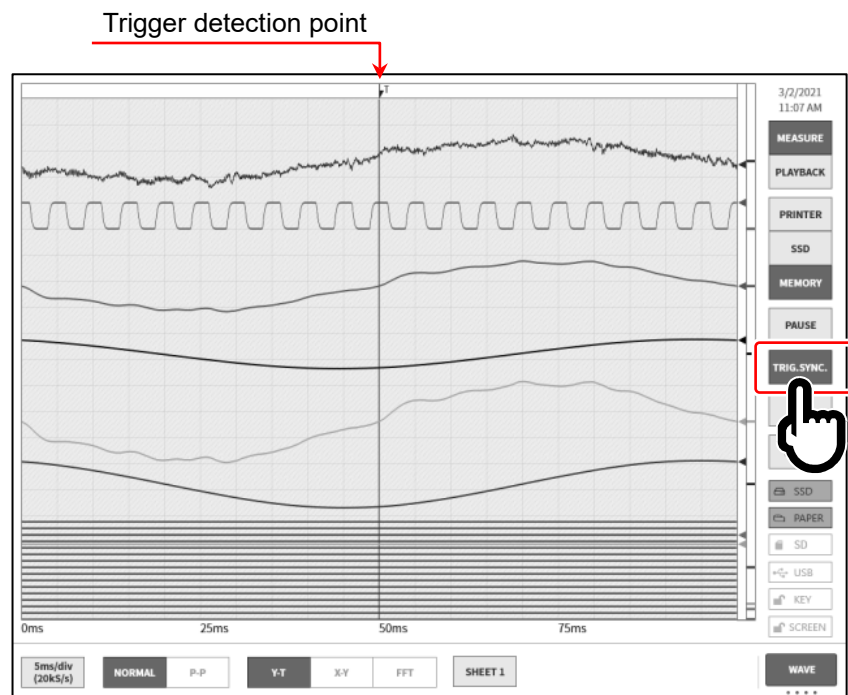

Sampling speed

Use the **Sampling speed** key on the left edge of the control bar to change the sampling speed according to the recording device. Set the optimal sampling speed while viewing the monitor waveform.

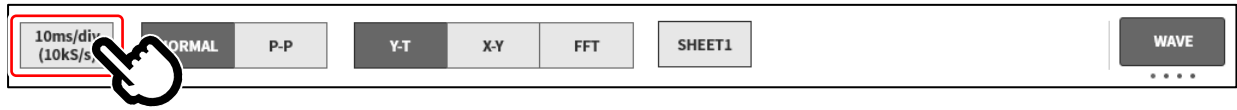

Set the optimal sampling speed while viewing the monitor waveform.
For details, see "4.4.1. Setup the Sampling Speed".

X-Y Waveform and FFT Analysis

When **SSD** is selected as the recording device and **NORMAL** is selected as the data format, FFT analysis and the X-Y waveform display for the control bar waveform format are enabled.

X-Y waveform conditions

- Recording device: SSD
- Sampling speed: 1 kS/s or lower
- Data format: NORMAL
- Analog input amp: 2 channels or above

X-Y waveform (Single screen format)

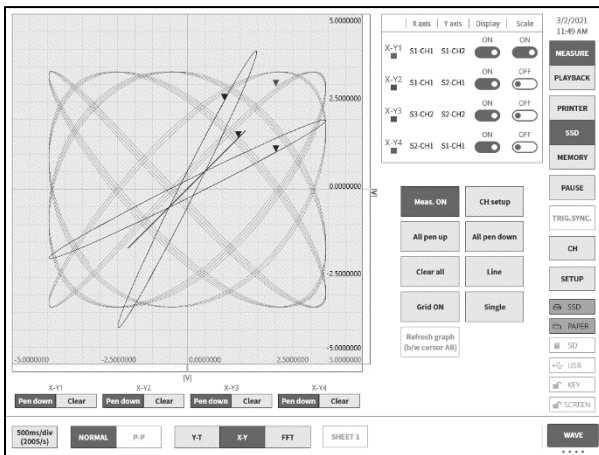

X-Y waveform (Quad screen format)

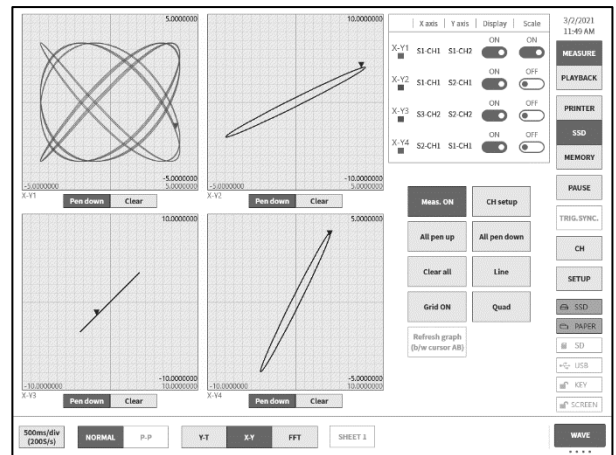

FFT Analysis

FFT analysis conditions

- Recording device: SSD
- Sampling speed: 1 MS/s or lower
- Data format: NORMAL
- Analog input amp: 1 channel or 2 channels

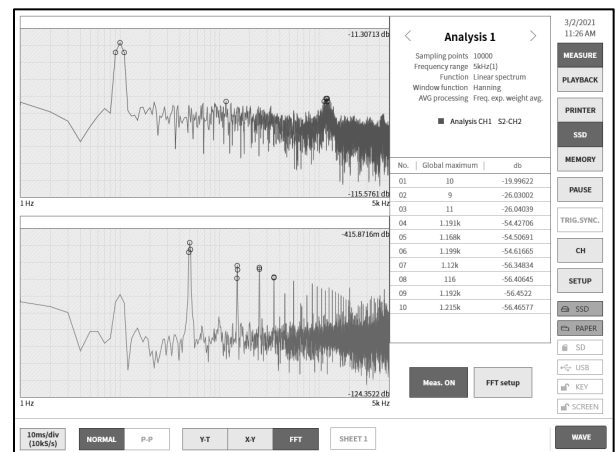

6.2.2. Pen Recording

Pen recording enables direct waveform printing to the recording paper without saving the measurement data.

This enables single-touch simple and certain waveform recording like a conventional pen recorder.

Pen Recording

Press the **PRINT** key on the operation panel when the waveform format is set to **Y-T** to perform real-time waveform printing with the printer block.

The chart speed (sampling speed) and input module settings can be changed while executing pen recording.

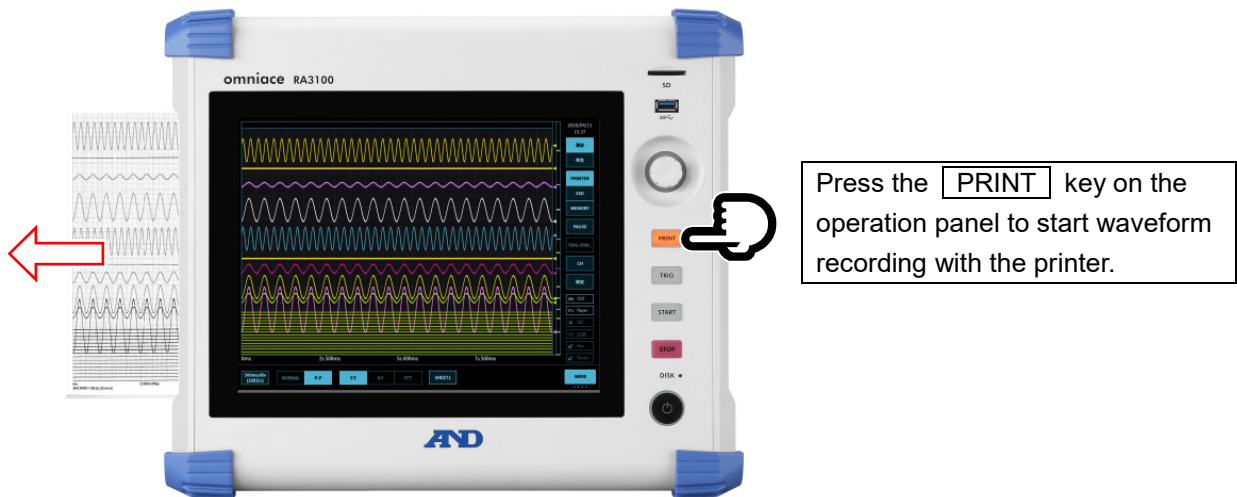

Pen Recording Mode

When **PRINTER** is selected as the recording device, tap the menu on the right edge of the control bar and select **PEN REC** to enter the pen recording mode, which enables unique functions for recording to recording paper.

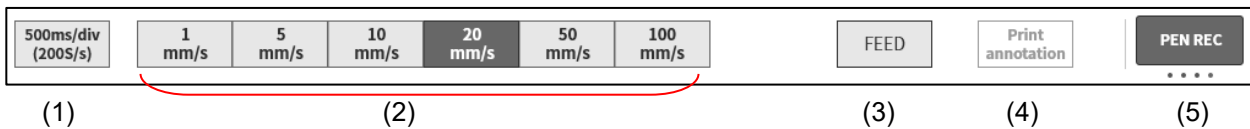

- (1) Sampling speed set in **WAVE** on the control bar
- (2) Chart speed (6 point): Frequently used recording speeds can be registered in the preferences to enable single-touch chart speed settings. See "Other setup" in "8.1.4 Printer".
- (3) FEED: The recording paper is fed (idle feeding) while this is pressed.
- (4) Print annotation: Tap this key during waveform recording to print annotations together with the waveform.

Setting the Chart Speed Keys

Follow the procedure below to set the chart speed keys.

Step 1. Tap the **【SETUP】** key on the **side menu** to display the setup menu.

Step 2. Tap **【Printer】** in **■ Recording setup** to display the printer related menu.

Step 3. Tap **【Other setup】** on the top of the [Printer] setup screen to display the chart speed key settings.

Step 4. Tap **【Chart speed key 1】** to **【Chart speed key 6】** to display the setting dialog. Tap the desired chart speed to set.

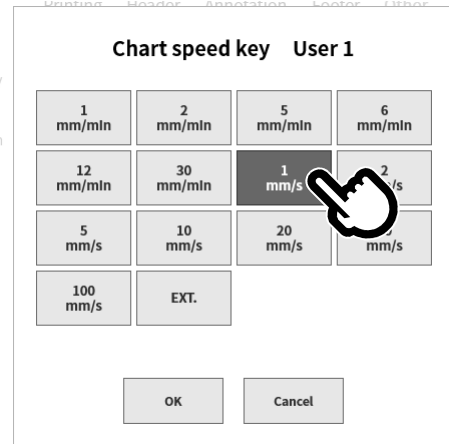
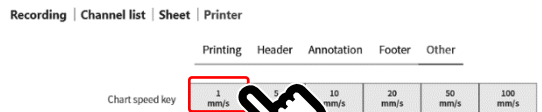
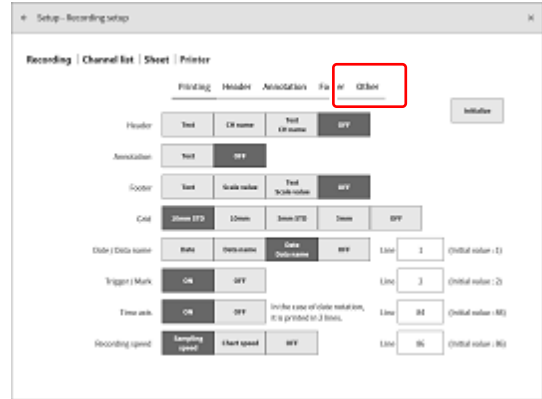
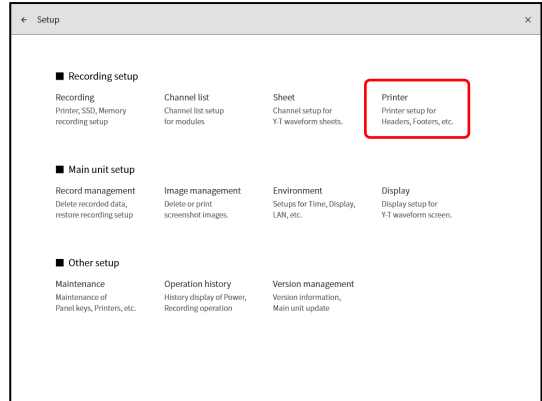

6.2.3. Setup and Printing Annotations

This product has a function for printing header, annotation, and footer text before, during, and after waveform recording with the printer.

Tap the **【Print annotation】** key during waveform recording to print annotations overlaid on the waveform. When CH name printing is enabled, the CH name is printed before printing the waveform.

Printing example

Header printing
Prints a header
before printing the
waveform

Prints CH name
before printing
the waveform

Prints annotations
overlaid on the
waveform

Press the **STOP** key or **PRINT**
key to end waveform printing.
Recording ends after printing the
footer.

The screenshot displays a multi-channel waveform recording interface. On the left, a header section titled "Title: Operation Check Test" contains test details: Test No. 0123456, Test Day March 3, 2021, Test Place Center, Tester OmniAce, and Test Contents (xxxxxxx, yyyyyyy, zzzzzzz). Below this, input conditions for channels CH1 through CH10 are listed. The central area shows a grid of waveforms for channels S1-CH1 through S6-CH2. Annotations like "A Voltage", "B Voltage", and "Temperature" are overlaid on the waveforms. On the right, a footer section titled "Title: Operation Check Test" contains Remarks and Input Conditions. At the bottom, the data speed is indicated as "DATA SPEED = 100 S/s (1 s/div)".

Setup Annotations

- Step 1. Tap the **【SETUP】** key on the **side menu** to display the setup menu.
- Step 2. Tap **【Printer】** in **■ Recording setup** to display the printer related setup menu.

Tap **[Header]**, **[Annotation]**, or **[Footer]** to display the corresponding settings screen. The setting method is the same for each.

- (1) Select the text to print.
- (2) Input text in the text area.
Double-tap the text area to display the software keyboard (9). Enter the text to print from the keyboard.
- (3) The **【Delete text】** key clears one row.
- (4) The **【Delete all】** key clears all the input text.
- (5) The **【Insert row】** key inserts one row in the specified row position.
- (6) The **【Delete row】** key deletes the specified row and brings the lower rows up.
- (7) The **【PRINT】** key prints the text ((2)) to the recording paper.
- (8) The **【Import/Export】** key exports (backs up) text to external media (such as an SD memory card or USB stick) or imports (reads) the text backed up to external media.
- (9) Software keyboard
Double-tap the position to input text to display the software keyboard.

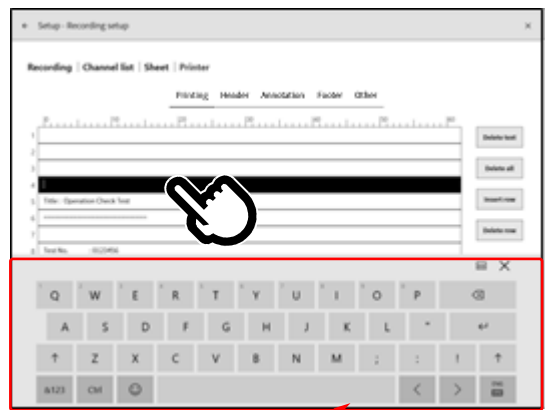
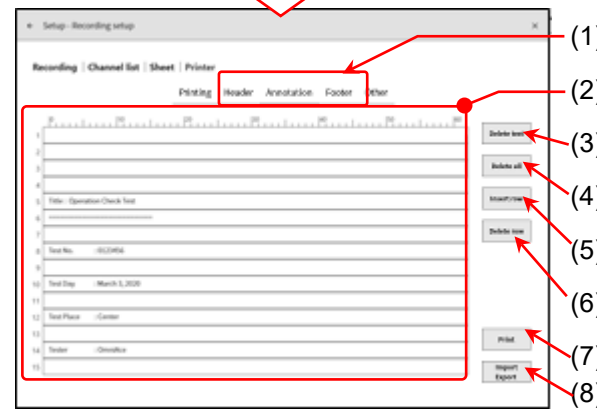
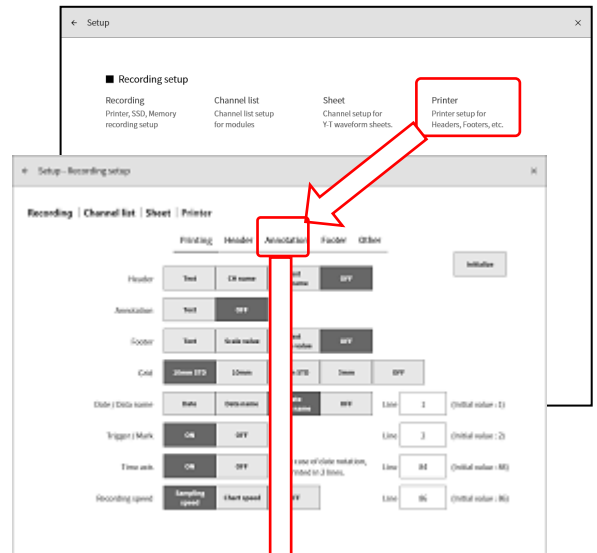

Importing and Exporting

The **【Import/Export】** key enables the header, annotation, and footer text set in the main unit to be saved to or imported from external media. On the import/export screen, a list of the text set in the main unit is displayed on the left and a list of the text saved to external media is displayed on the right.

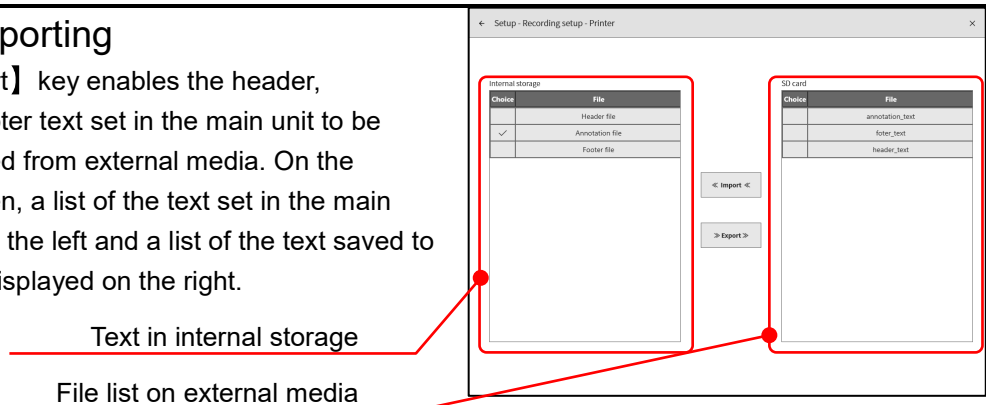

Text in internal storage

File list on external media

Export

Save the text set in the main unit to external media. Place a check mark on the left of the text to save (for example, annotations), and tap the **【Export】** key in the center to save the annotation text to external media.

Place a check mark on the text to save

Tap the **【Export】** key

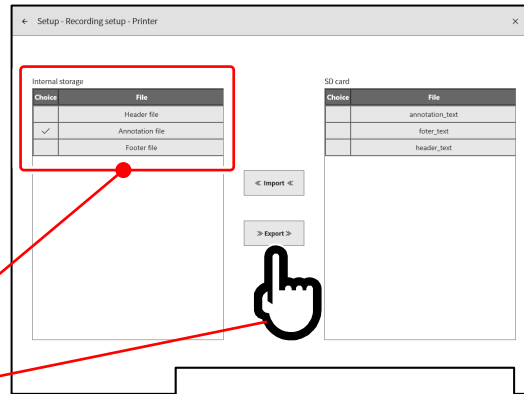

Enter the file name and tap the **【OK】** key to save the text to external media with the specified file name.

Saved with the specified file name

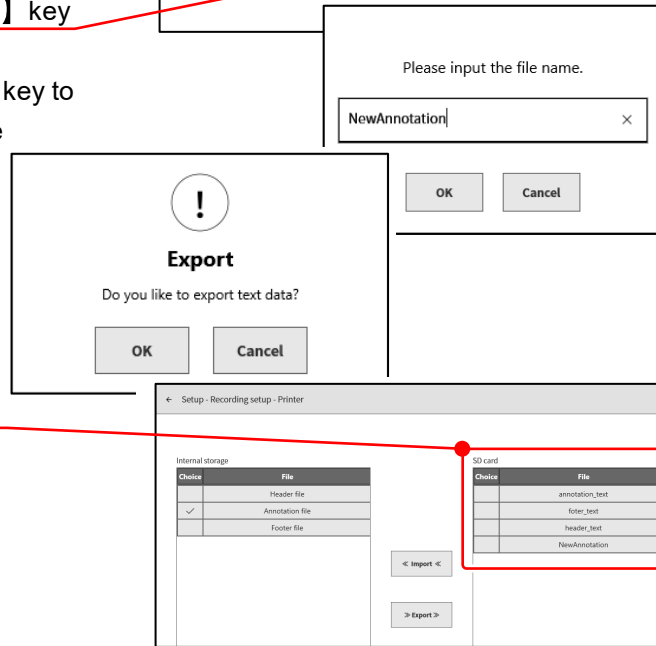

NOTE

- The import/output folder of external media is fixed to "(drive name of external media)¥RA3100¥Text¥". The text file is "filename.txt" and the file extension is ".txt". To create a text file using the text editor on a computer and import it to the RA3100, create the above folder and insert the file in that folder. The above folder is automatically created by executing the export process. It is recommended that you execute the export process once to ensure the correct folder name.

Import

Reads a text file saved to external media to the main unit.

Place a check mark on the file to import in the text file list on the right of the import/export screen and tap the **【Import】** key on the center to display the dialog box for selecting the import destination.

Select the import destination and tap the **【OK】** key to read the text file.

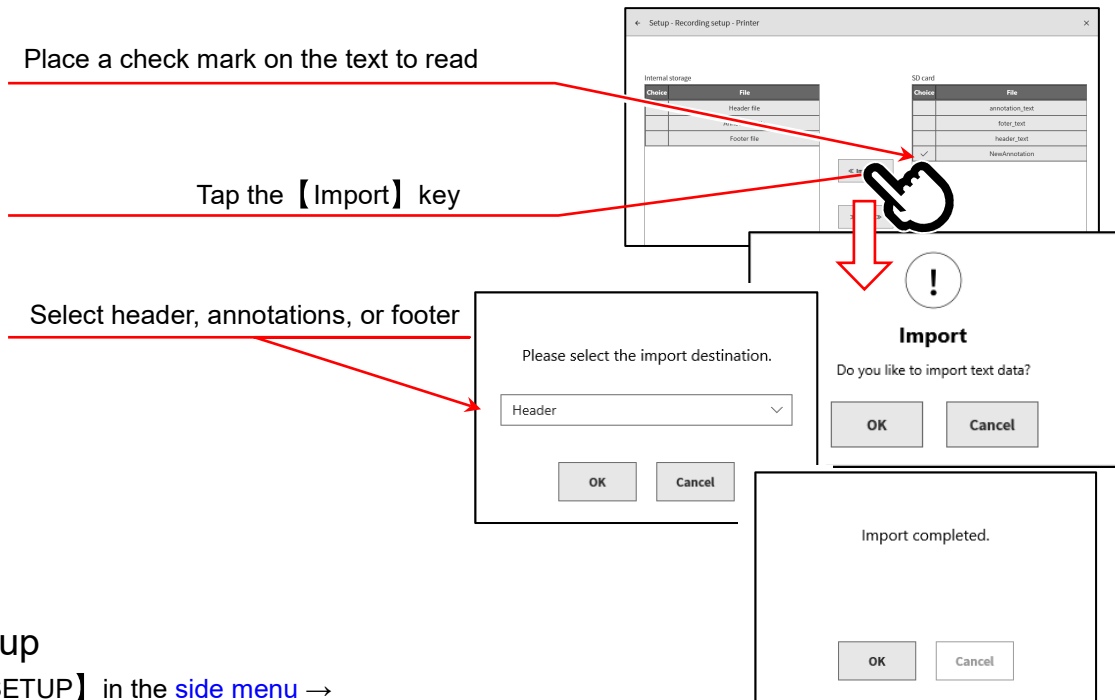

Print Setup

Tap **【SETUP】** in the [side menu](#) → **【Recording setup】** → **【Printer】** → **【Printing】** to display the [Printing] setup screen, where the information printed while printing the waveform with printer recording can be set.

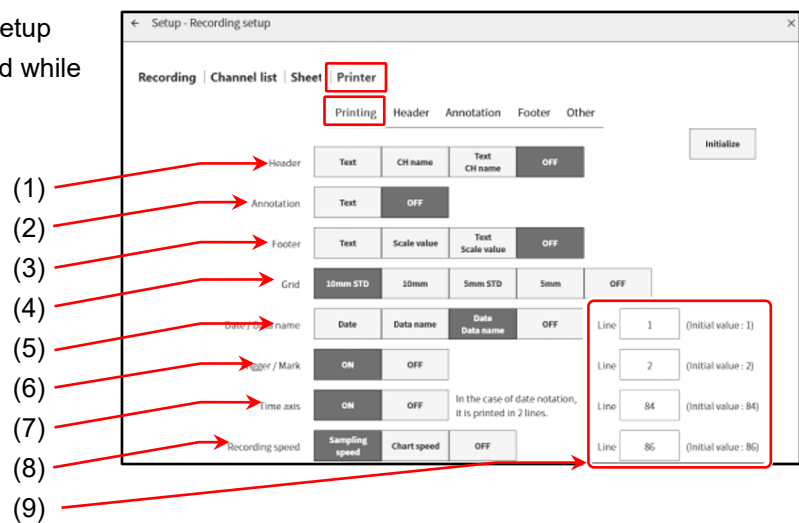

- (1) Header: Prints the header text/CH name before printing the waveform.
- (2) Annotation: Prints annotations together with the waveform.
- (3) Footer: Prints the footer/scale after waveform printing ends.
- (4) Grid: Selects the grid to print while printing the waveform.
- (5) Date: Prints the date and time of recording while printing the waveform.
- (6) Data name: Prints the data name while printing the waveform.
- (7) Time axis: Prints the time below the recording while printing the waveform.
- (8) Recording speed: Prints the recording speed (sampling/chart speed) while printing the waveform.
- (9) Print lines: Specify the print position of the date/recording name, trigger/mark, time axis, and recording speed using line numbers.

6.3. Starting and Ending Recording

This product has three recording devices: printer, memory, or SSD. When recording is enabled for a device, the data recorded to each device is recorded to the SSD while it is recorded to the device. For the printer, the waveform data (P-P values) printed to the recording paper are also recorded to the SSD.

For the memory, the memory data is recorded to the SSD when memory recording ends.

6.3.1. Recording Setup

Tap **【SETUP】** → **【Recording setup】** on the [side menu](#).

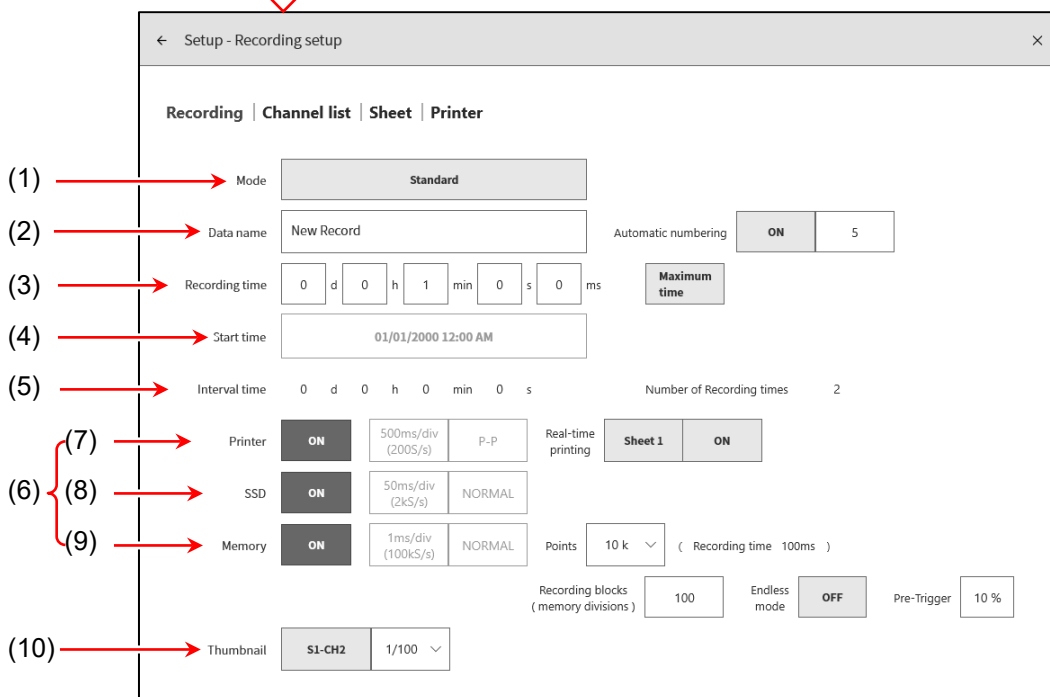
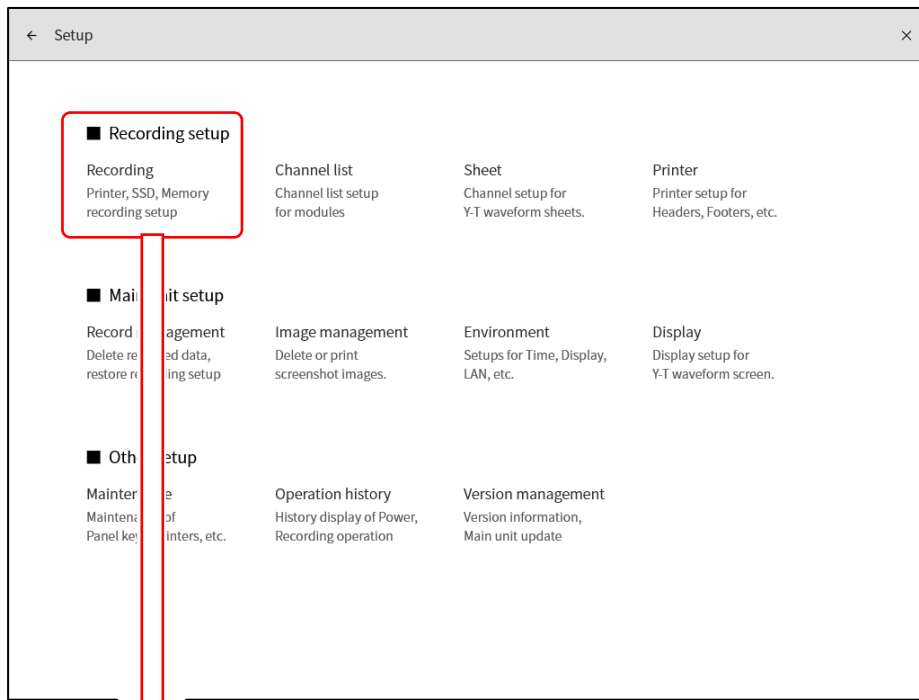

-
- (1) Mode: Selects the optimal mode from the nine recording modes.
- (2) Data name: Specifies the name of the recorded data.
When [Automatic numbering] is enabled, numbers are automatically appended to the name.
- (3) Recording time: Ends recording after recording for the specified time after recording starts.
- (4) Start time: Starts recording at the specified time after starting measurement with the **START** key.
- (5) Interval time: Performs recording at the specified interval. Recording ends when recording has been performed the number of times specified in [Number of Recording times].
- (6) Recording device: Enables/disables recording to the recording device (Printer, SSD, or Memory).
The devices can be set independently.
- (7) Printer: Enables/disables printer recording.
When enabled, the P-P data is recorded to the SSD with sampling of printer recording.
- Real-time printing: When printer recording is enabled, real-time printing to the printer can be enabled/disabled.
When enabled, the waveform of the specified sheet is printed from the printer while saving the data of the printer recording.
When disabled, printing to the printer is not performed.
- (8) SSD: Enables/disables [SSD].
- (9) Memory: Enables/disables [Memory].
- Points: Specifies the sampling count (the data count per channel) to record for each memory recording.
- Recording blocks: Specifies the number of blocks to record for memory recording.
- Endless mode: When the endless mode is enabled, the blocks start to be overwritten from the first block when the record blocks are full.
- Pre-trigger: Sets the pre-trigger in the memory block.
- (10) Thumbnail: Specifies the channels to display thumbnails for and the compression rate.

Mode

This product has nine recording modes to enable complex measurement to be easily set.

Press the **Mode** key to display an explanation of each recording mode on the monitor and select a mode suitable for the measurement to perform.

- | | |
|--------------------------------|---|
| (1) Standard | (6) Start trigger + Interval (N times) |
| (2) Start time | (7) Start time + interval (N times) |
| (3) Start trigger | (8) Start time + Start trigger + interval (N times) |
| (4) Interval (N times) | (9) Window recording |
| (5) Start time + Start trigger | |

(1) Standard

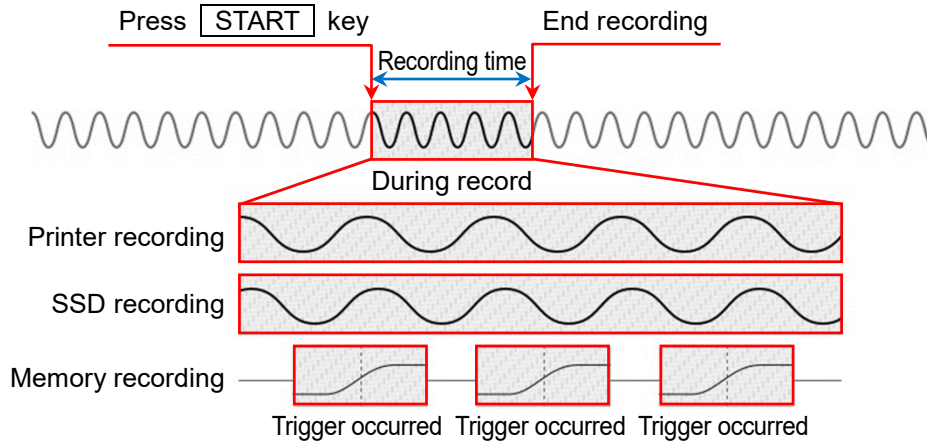

When the **START** key on the operation panel is pressed, recording to the various devices specified in the **Setup** menu starts, and continues until the time set in **Recording time** in the recording setup elapses or the **STOP** key on the operation panel is pressed. Memory recording records the input data to memory when the trigger is occurred after recording starts. Data recording is not performed unless a trigger is detected.

(2) Start time

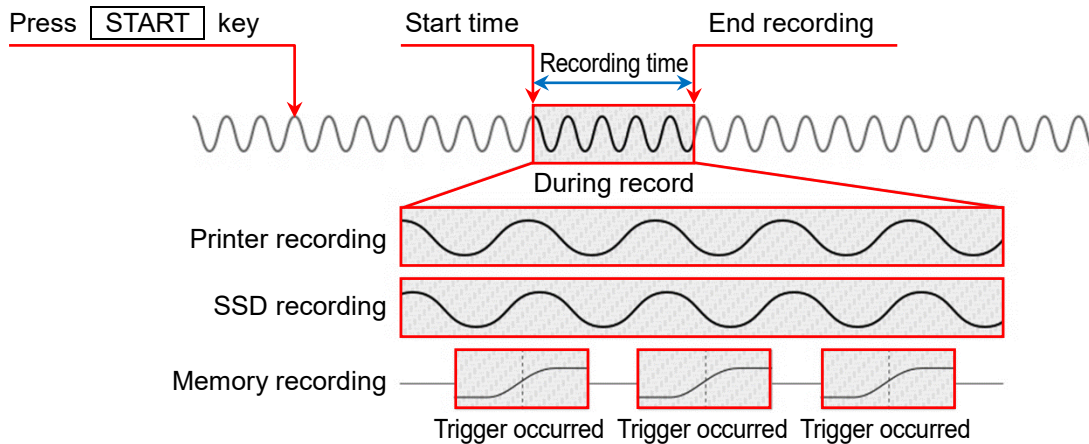

When the **START** key on the operation panel is pressed, the product enters the measurement standby state and recording to the various devices starts at the **Start time** set in the recording setup, and continues until the time set in **Recording time** in the recording setup elapses or the **STOP** key on the operation panel is pressed.

(3) Start trigger

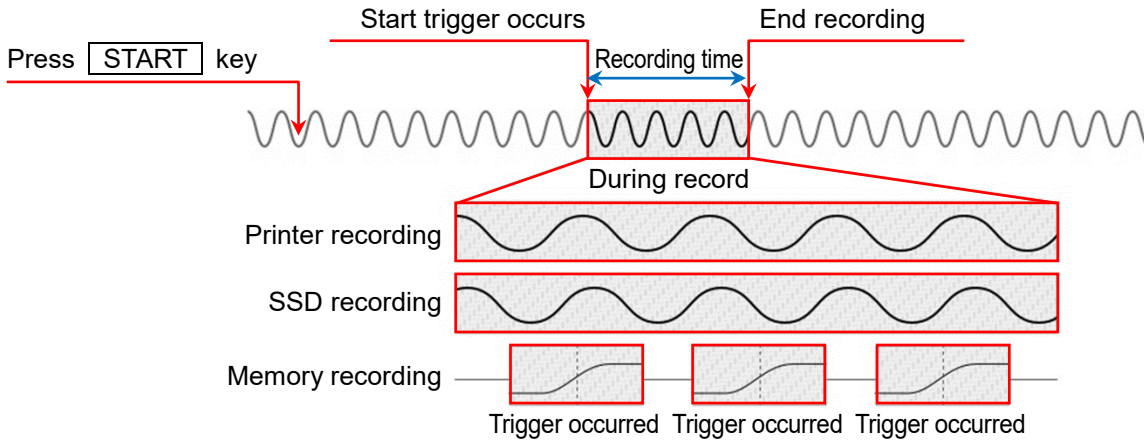

When the **START** key on the operation panel is pressed, the product enters the measurement standby state. Recording to the various devices starts when the channel trigger specified in **Start trigger** is occurred and continues until the time set in **Recording time** in the recording setup elapses or the **STOP** key on the operation panel is pressed.

(4) Interval (N times)

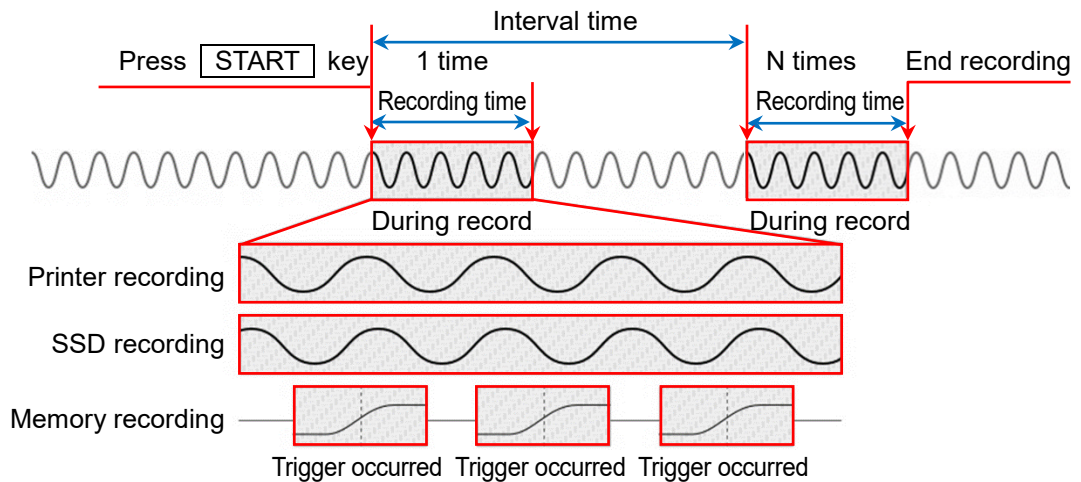

When the **START** key on the operation panel is pressed, recording to the various devices starts and continues until the time set in **Recording time** in the recording setup elapses, and then the next recording starts when the time in **Interval time** elapses after measurement starts. Measurement ends when recording has been performed the number of times specified in **Number of Recording times** for the interval.

(5) Start time + Start trigger

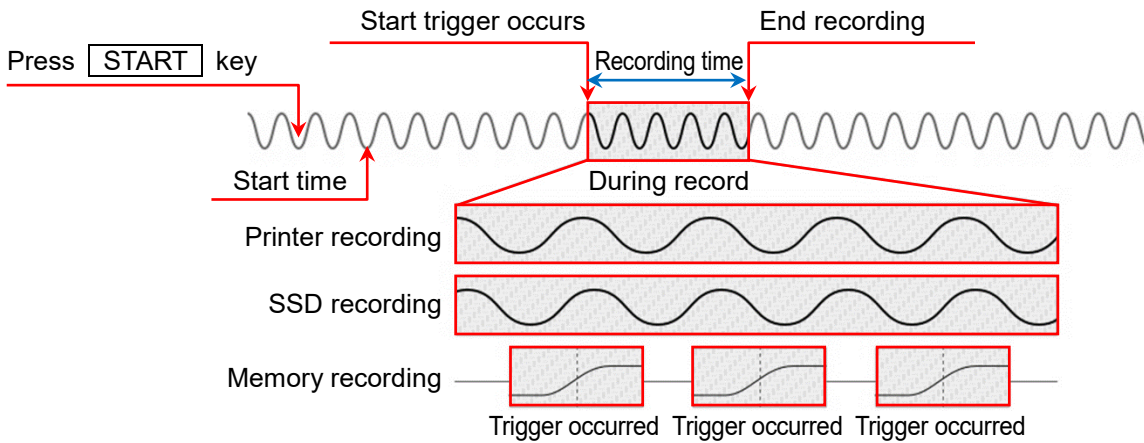

When the **START** key on the operation panel is pressed, the product enters the measurement standby state after the time set in **Start time**. Recording to the various devices starts when the channel trigger specified in **Start trigger** is occurred, and continues until the time set in **Recording time** in the recording setup elapses or the **STOP** key on the operation panel is pressed.

(6) Start trigger + Interval (N times)

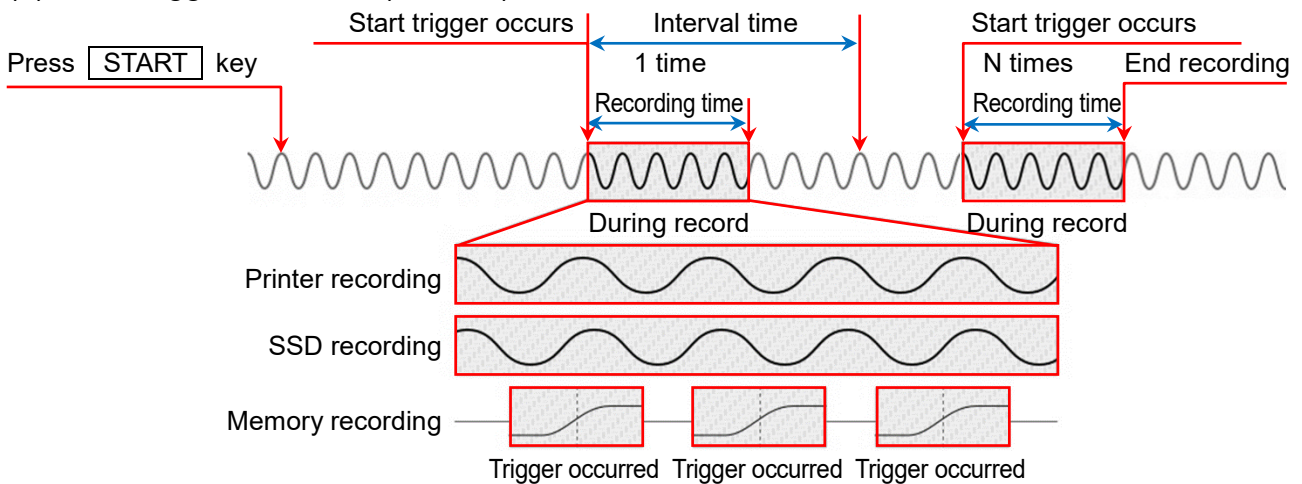

When the **START** key on the operation panel is pressed, the product enters the measurement standby state and recording starts when the channel trigger specified in **Start trigger** is occurred. Measurement continues until the time set in **Recording time** in the recording setup elapses, and then the next recording starts when the time in **Interval time** elapses after recording starts, and the product waits for the next start trigger.

(7) Start time + Interval (N times)

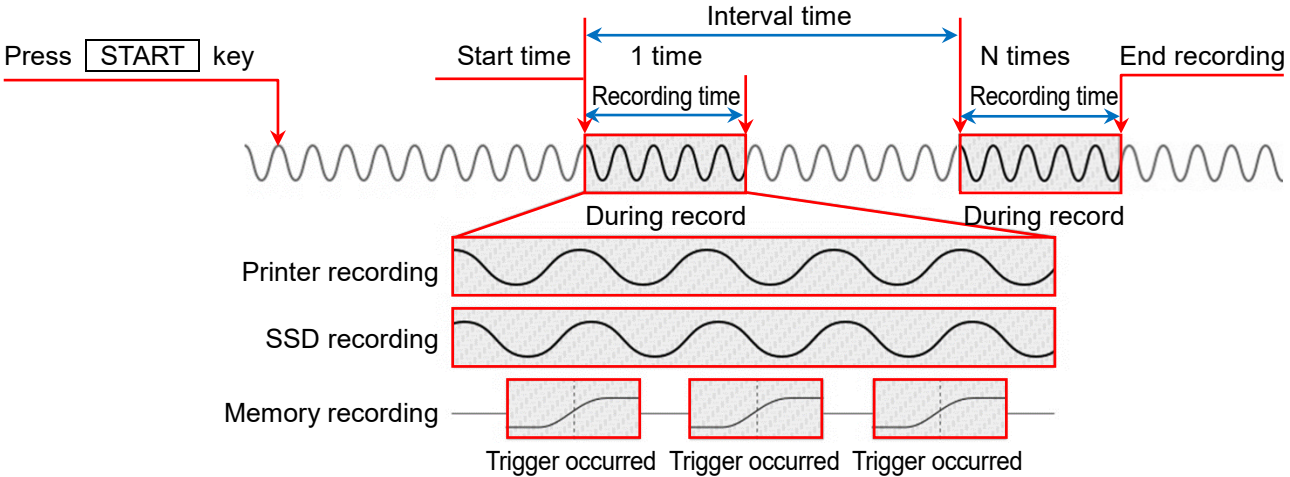

When the **START** key on the operation panel is pressed, the product enters the measurement standby state. Recording starts at the time set in **Start time**, then continues recording for the time set in **Recording time**.
 Measurement repeats at the interval set in **Interval time**.

(8) Start time + Start trigger + Interval (N times)

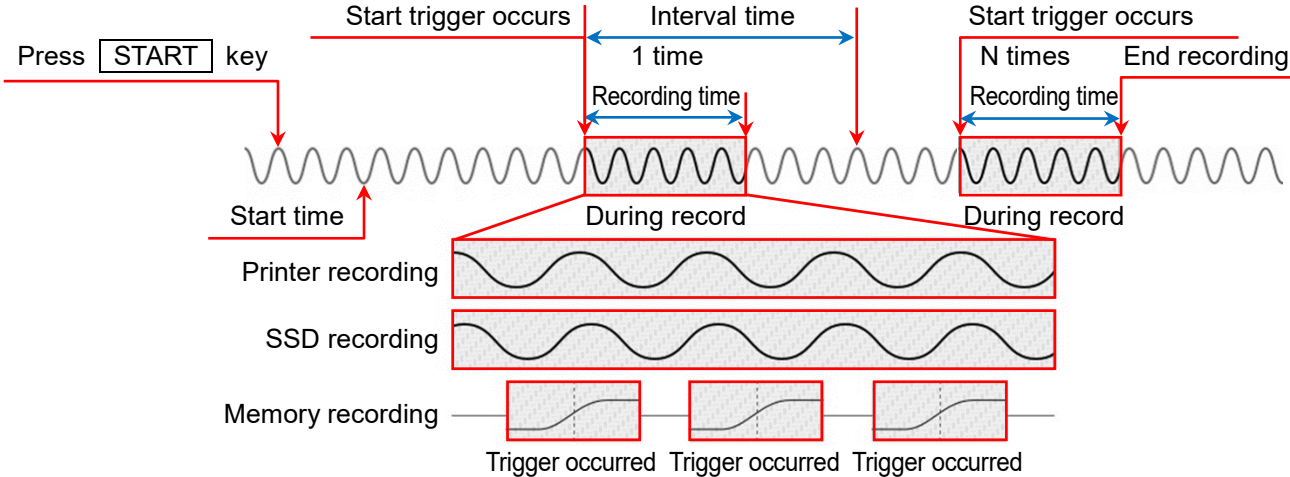

When the **START** key on the operation panel is pressed, the product enters the measurement standby state and starts the procedure indicated in "(6) Start trigger + Interval (N times)" at the time set in **Start time**.

(9) Window recording

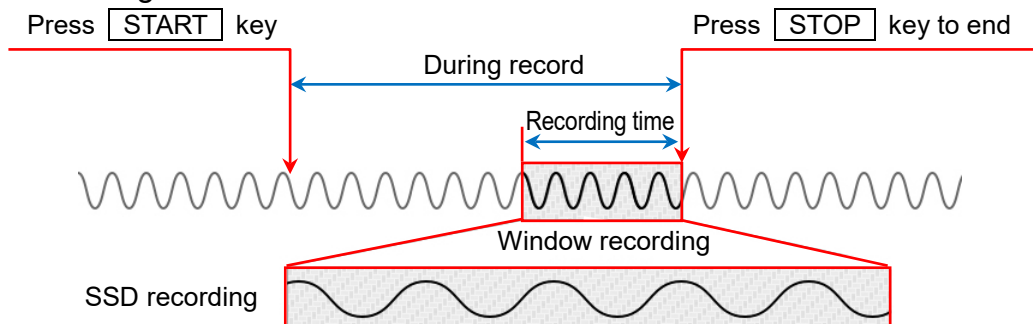

When the [START] key on the operation panel is pressed, recording to the various devices starts, and continues until the [STOP] key on the operation panel is pressed. The data of the time set in 【Recording time】 until stop is recorded to the SSD.

6.3.2. Starting and Ending Recording

Start recording

Press the **START** key on the operation panel to start device recording and enclose the screen with a red frame.

Red frame

When the memory waveform is displayed on the monitor, you can display the **Trigger** tab from **CH** on the **side menu** to display [Memory block] for checking the state of recording to the memory block.

Each time a trigger is detected and recording to the memory block is performed, the display is updated with the latest waveform and used block count.

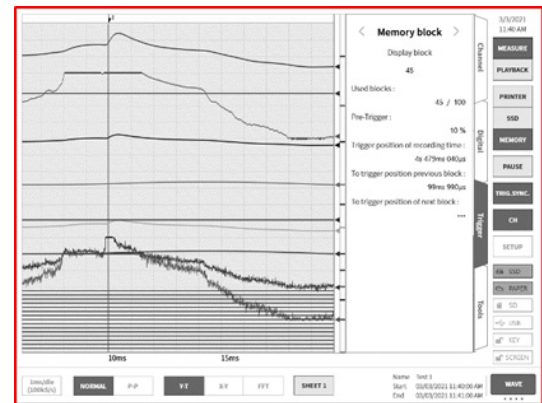
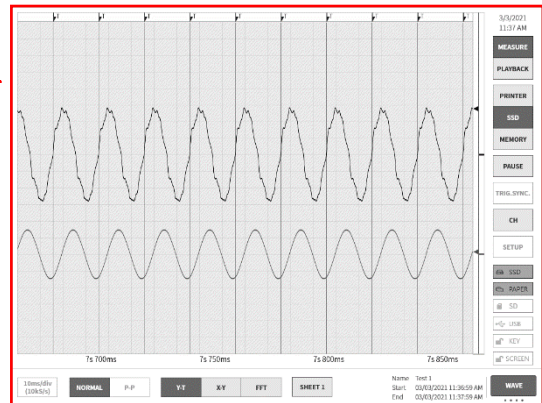

Stop recording

Recording ends when the recording time set in **Recording time** elapses or when the **STOP** key on the operation panel is pressed. Then the monitor screen automatically switches to the **PLAYBACK** screen and displays the last recording data. The screen is enclosed in a green frame on the **PLAYBACK** screen.

Green frame

When the memory waveform is displayed on the monitor, you can display the **Trigger** tab from **CH** on the **side menu** to display [Memory block] for checking the recorded memory data.

You can tap **Display block** in the memory waveform playback to change the recorded block with the rotary knob.

Tap and change the display block with the rotary knob

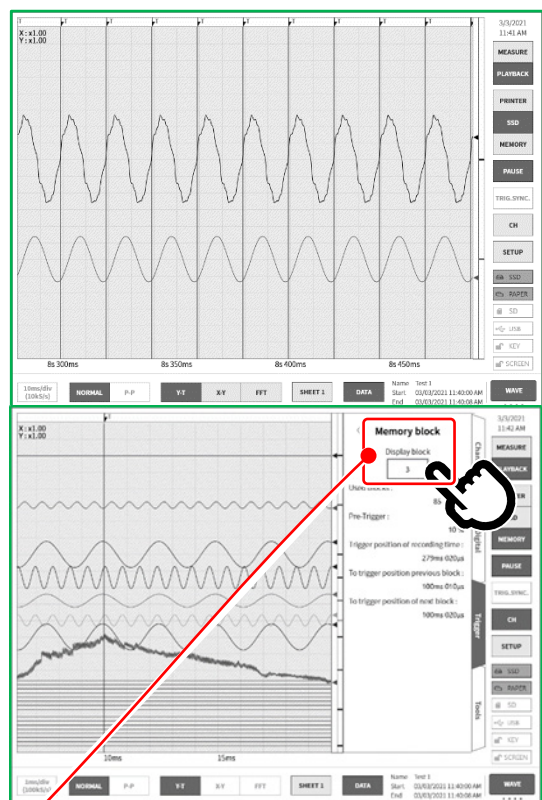

6.3.3. Pausing Recording and Scrolling Back

Start recording with the printer recorded or SSD recorded waveform displayed on the waveform monitor. The **【PAUSE】** key can be tapped on the [side menu](#) during recording to stop the monitor waveform but continue recording. Since the product is still in the recording state, **【MEASURE】** is selected on the [side menu](#) and the waveform frame remains red. Scroll the waveform monitor to the right in this state to scroll the waveform back and check the past waveform that has already been recorded. Scroll the waveform monitor to the left to display the waveform recorded after pausing. You can also pinch in (reduce)/pinch out (expand) the waveform. Tap the **【PAUSE】** key again to monitor the waveform with the latest data.

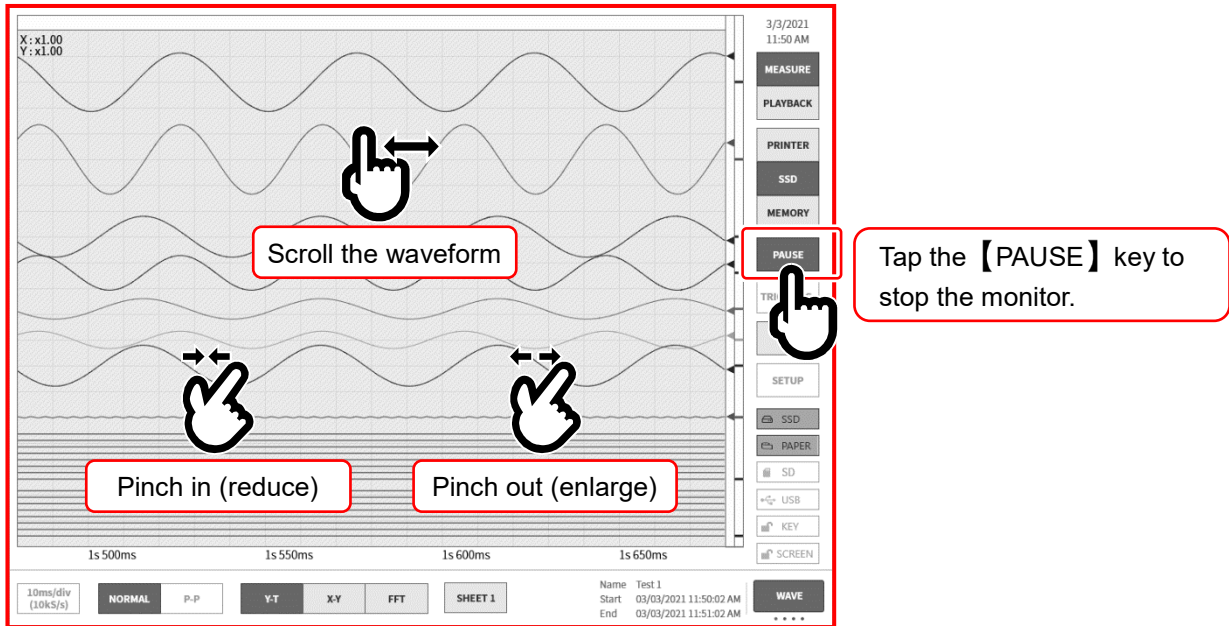

7. Playback Recorded Data

To playback recorded data, tap **【PLAYBACK】** for **【MEASURE/PLAYBACK】** on the **side menu** to switch the monitor to the playback screen. The monitor automatically switches to the playback screen when measurement ends.

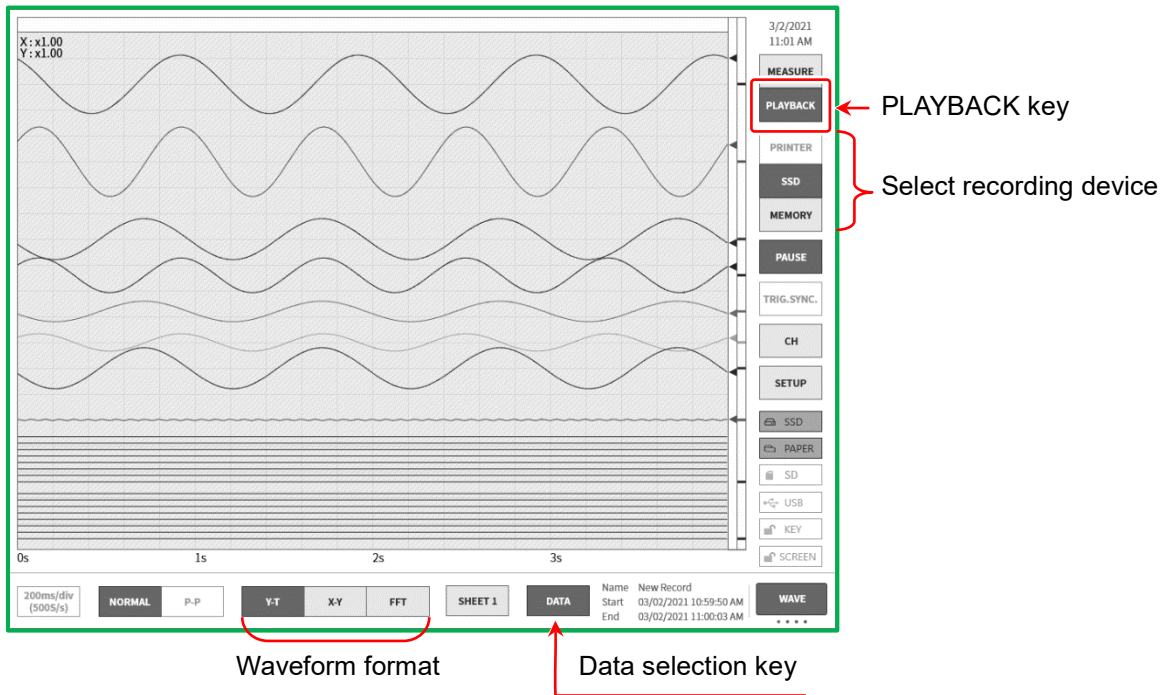

7.1. Select Recorded Data

Tap the **【DATA】** selection key on the control bar to display the recorded data list indicated below. Select the data and tap the **【OK】** key to display that waveform.

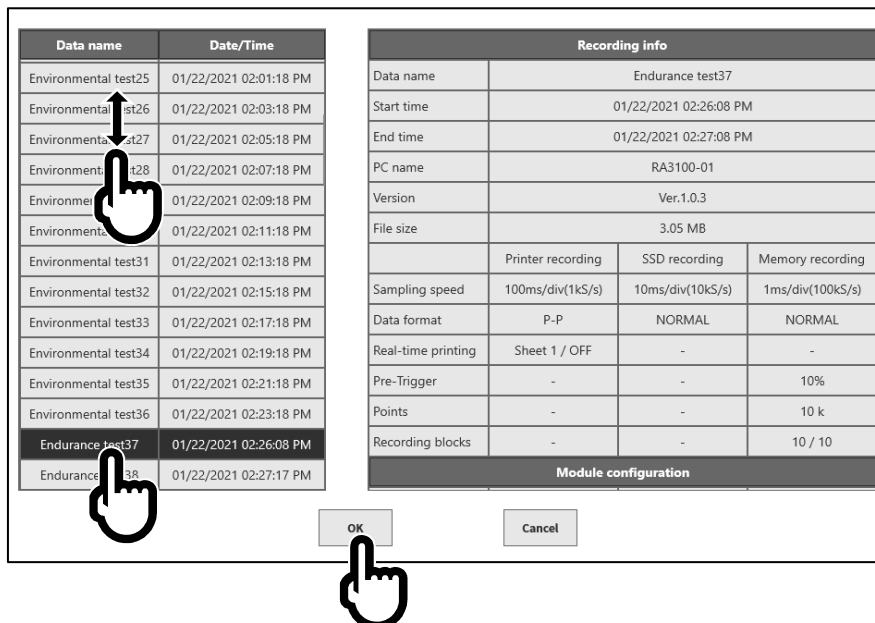

- Data name:** The recording name set in the recording settings. Setting an easy-to-understand name when recording makes it easier to search for the data to playback.
- Date/Time:** The date and time that the data was recorded
- Recording info:** Displays information on the selected recorded data.

Selection procedure

- Step 1. Tap the **【DATA】** key on the control bar to display the recorded data list.
- Step 2. Swipe the recorded data list up or down to move the displayed list up or down.
- Step 3. When you have found the data to display, tap that data.
- Step 4. Tap **【OK】** on the bottom of the list to display the selected recorded data on the monitor.

7.2. Playback Recorded Data

By displaying recording data in the waveform monitor and selecting a device in the [side menu](#), the waveform for each device when recording is displayed.

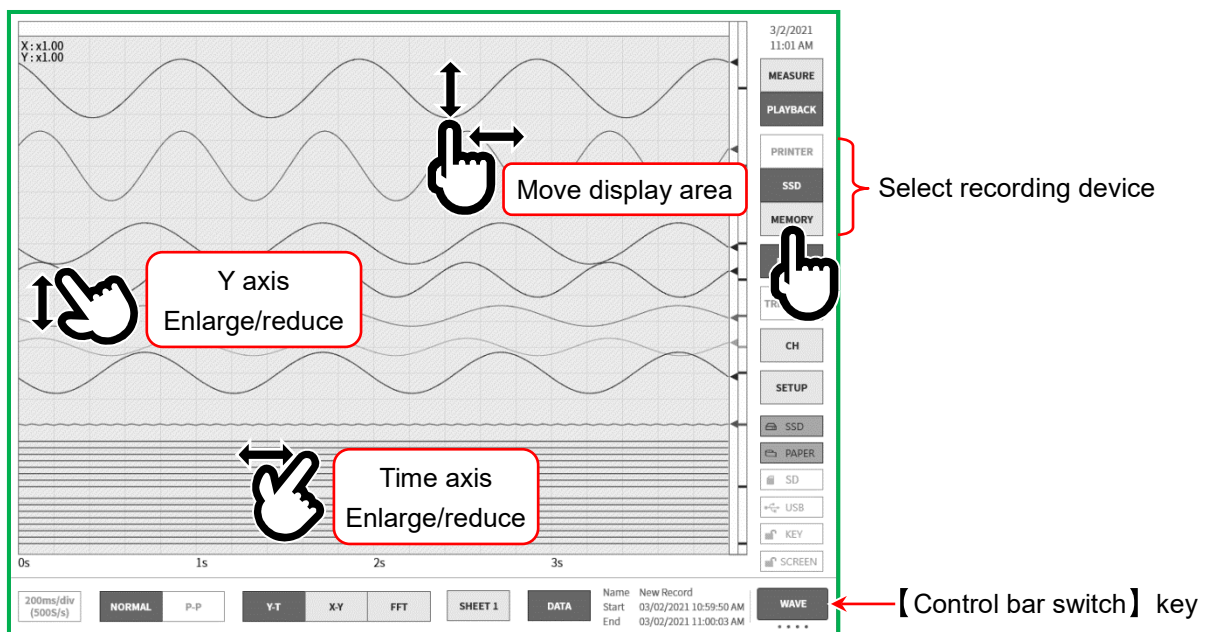

7.2.1. Playback Screen Operations

Enlarging/Reducing the Waveform

Pinch in/out the waveform monitor in the time axis direction to enlarge/reduce in the time axis direction and pinch in/out in the amplitude direction to enlarge/reduce in the amplitude direction. The enlargement ratio is displayed in the zoom ratio on the top left of the monitor.

Scrolling

You can use one finger on the waveform monitor to drag the screen up, down, left, or right to move the display area.

7.2.2. Thumbnails

Tap the **【Control bar switch】** key to switch the functions on the control bar in the order **【WAVE】** ⇒ **【THUMBNAIL】** ⇒ **【CURSOR】** ⇒ **【PEN REC】** ⇒ **【WAVE】**.

Select **【THUMBNAIL】** to display the thumbnail waveform of the channel set in the recording setup menu in the control bar area.

You can also tap the **【thumbnail display channel】** key to select the channel to display.

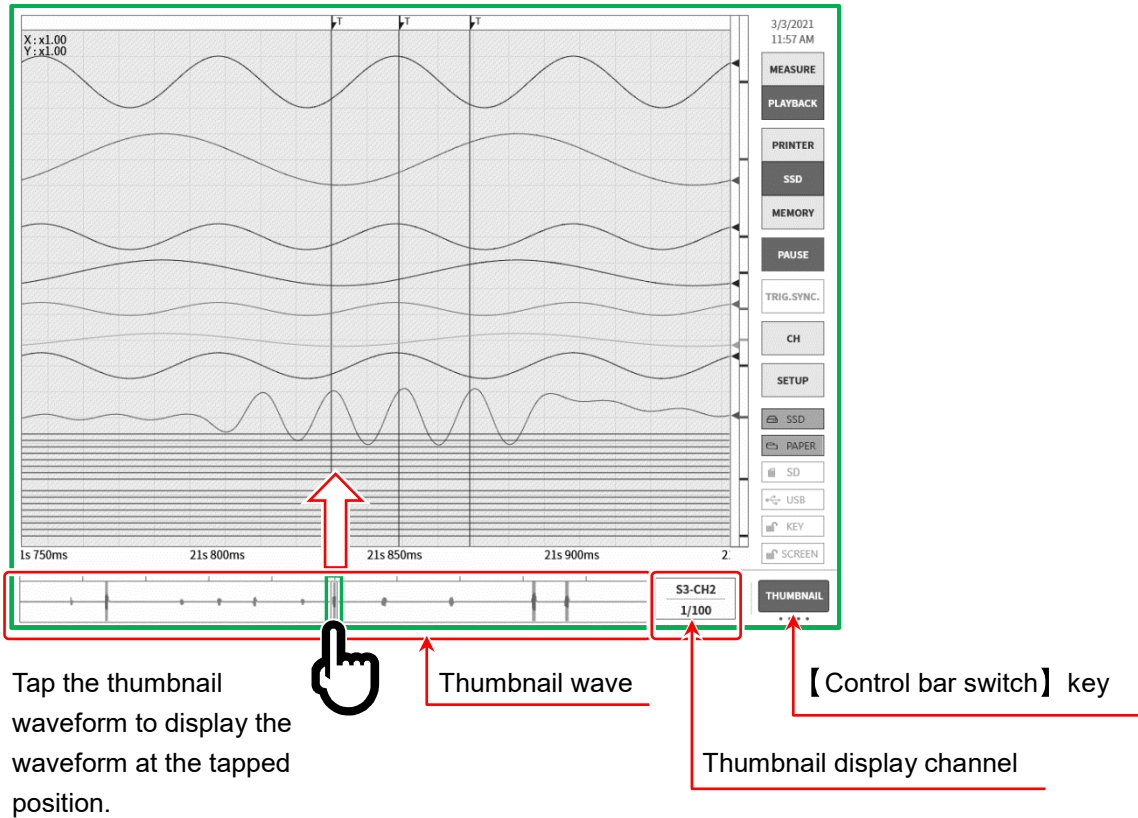

Thumbnail display channel

Tap the thumbnail display channel (in red) in **【THUMBNAIL】** to display the channel selection dialog. Select one channel with analog input module measurement enabled. The waveform cannot be displayed in the thumbnail of a logic channel.

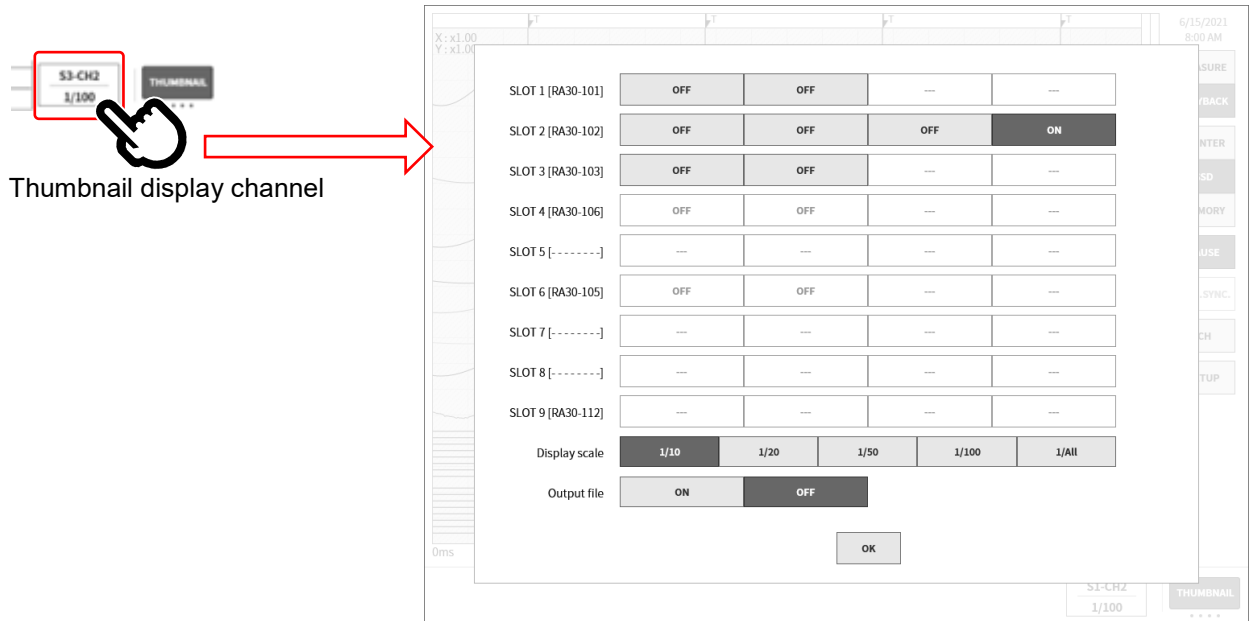

Display scale: 1/10, 1/20, 1/50, 1/100, 1/All

Making the scale smaller (with a larger decimation number for the data to display) displays a wider time range of the waveform, because the number of points to display is the same. 1/10 is the 10 x time range, and 1/50 is the 50 x time range. 1/All cannot be selected in the measurement mode.

Output file: OFF, ON

The thumbnail display reads the recorded data and performs decimation.

OFF Do not output the data for display to the SSD.
Decimation occurs each time the recorded data is switched.

ON Output the data for display to the SSD. When set to ON, the display process is faster because decimation is not required, but more SSD space is consumed.

7.2.3. Cursor

When **[CURSOR]** is selected for the **[control bar switch]** on the right edge of the control bar, the A and B time axis cursors are displayed.

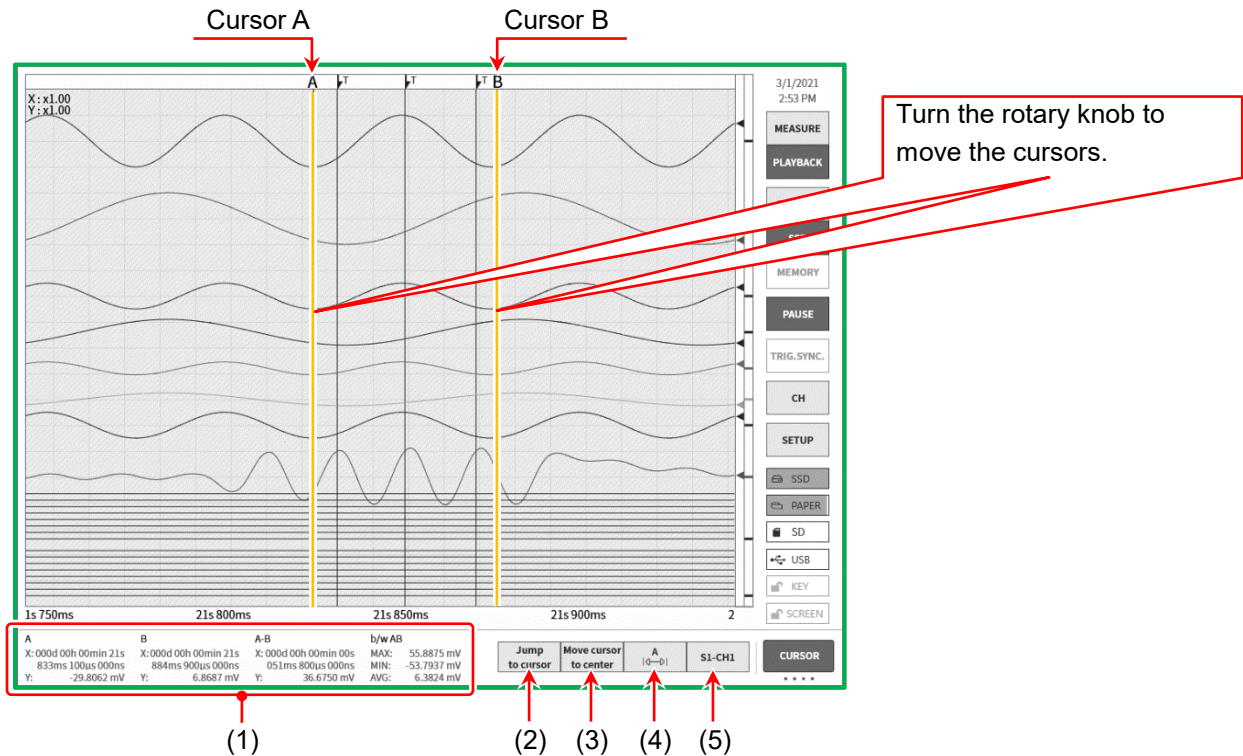

(1) Cursor position data information

A: Recorded data information of the cursor A position

X is the time from the first of cursor A, and Y is the data value at the position of cursor A.

B: Recorded data information of the cursor B position

X is the time from the first of cursor B, and Y is the data value at the position of cursor B.

A-B: Information on the difference between cursors A and B

X is the time between cursors A and B, and Y is the data difference value between cursors A and B.

b/w AB: The maximum value (MAX), minimum value (MIN), and average value (AVG) between cursors A and B.

However, this is disabled for printer recorded data because the P-P value is used. It is also disabled when the P-P value is selected for SSD recording.

(2) **[Jump to cursor]** key

Tap the key to move the waveform so that the cursor position is in the monitor center.

(3) **[Move cursor to center]** key

Tap the key to move the specified cursor to the monitor center.

(4) Cursor selection

Select the cursor to change the cursor position for.

The cursor switches in the order **[A]** ⇒ **[B]** ⇒ **[A-B]** each tap.

Turn the rotary knob with **[A]** selected to move the cursor position of cursor A.

Turn the rotary knob with **[B]** selected to move the cursor position of cursor B.

Turn the rotary knob with **[A-B]** selected to move the cursor with the distance between A and B retained.

(5) Channel selection

Selects the channel to display in the cursor position information. Tap the **【channel selection】** key to display the channel selection screen indicated below, where you can select the channel to display in the cursor position information.

	CH1	CH2	CH3	CH4
SLOT1 [RA30-101]	ON	OFF	---	---
SLOT2 [RA30-102]	OFF	OFF	OFF	OFF
SLOT3 [RA30-103]	OFF	OFF	---	---
SLOT4 [RA30-106]	OFF	OFF	---	---
SLOT5 [-----]	---	---	---	---
SLOT6 [RA30-105]	OFF	OFF	---	---
SLOT7 [-----]	---	---	---	---
SLOT8 [-----]	---	---	---	---
SLOT9 [RA30-112]	---	---	---	---

OK

7.2.4. Printing Out

Press the **PRINT** key on the operation panel with the waveform of the recording data displayed to use the printer to print the waveform between cursors A and B on the monitor.

NOTE

- After reading recorded data, cursor A indicates the start of the data and cursor B indicates the end of the data.

Even if the time axis or waveform amplitude is enlarged on the monitor, the printer prints the recorded time axis and amplitude set in the channel setup.

7.3. X-Y Waveform

Data recorded with the following conditions can be used to display the X-Y waveform if **【X-Y】** is selected as the waveform format in the control bar. The X-Y waveform enables four waveforms (X-Y1 to X-Y4) to be displayed at the same time.

X-Y waveform conditions

- Recording device: SSD
- Sampling speed: 1 kS/s or lower
- Data format: NORMAL
- Analog input amp: 2 channels or above

- X-Y waveform display
- 7. 3. 1. X-Y Display Settings
- 7. 3. 2. X-Y Control

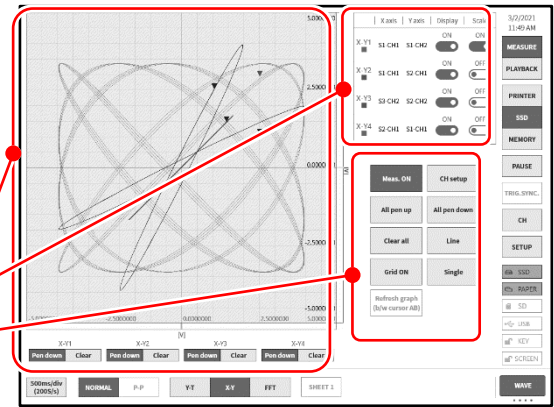

By tapping the **【Single/Quad】** key for display control, the X-Y waveform can be displayed as four waveforms overlaid on a single screen or as four separate screens.

X-Y waveform (Single screen format)

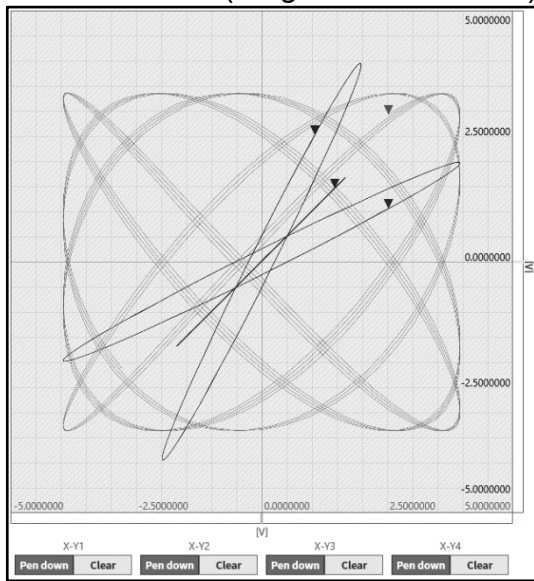

X-Y waveform (Quad screen format)

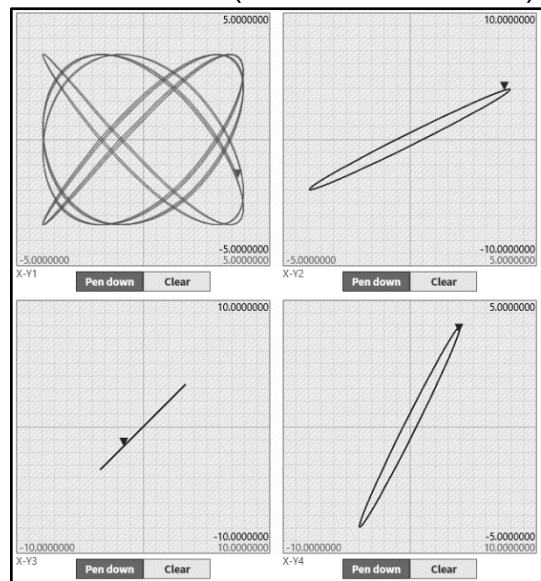

7.3.1. X-Y Display Setup

The horizontal axis of the display settings box indicates the setting state of waveforms X-Y1 to X-Y4 and allows the display to be switched on or off. With the single screen display, specifies the scale of which channel to display.

- X axis, Y axis: Display the slot and channel number of each axis.
- Display: Switches the X-Y waveform display on/off
- Scale: Switches the scale display on/off

	X axis	Y axis	Display	Scale
X-Y1	S1-CH1	S1-CH2	<input type="checkbox"/>	<input type="checkbox"/>
X-Y2	S1-CH1	S2-CH1	<input type="checkbox"/>	<input type="checkbox"/>
X-Y3	S3-CH2	S2-CH2	<input type="checkbox"/>	<input type="checkbox"/>
X-Y4	S2-CH1	S1-CH1	<input type="checkbox"/>	<input type="checkbox"/>

7.3.2. X-Y Control

- (1) Meas. ON:
Enables/disables X-Y measurement.
- (2) All pen up:
Tap this key when the X-Y waveform is displayed on the monitor to pause the X-Y waveform display. This enables unnecessary waveforms to not be inserted when switching the monitored input signal, etc.
- (3) Clear all:
Clears all the X-Y waveform and starts the display again.
- (4) Grid ON/OFF:
Switches the grid lines of the X-Y waveform display area on or off.
- (5) Refresh graph (b/w cursor AB):
Displays the Y-T waveform with the playback mode and displays the X-Y waveform with the range specified by cursors A and B.
- (6) CH setup:
Configures the channel settings for waveforms X-Y1 to X-Y4.
Tap this key to switch to the [X-Y channel settings] screen to configure the X axis and Y axis channel settings for each waveform.
- (7) All pen down:
Resumes waveform display when it has been paused with [All pen up].
- (8) Dot/Line:
Switches between rendering the X-Y waveform with dots or rendering it with lines.
- (9) Single/Quad:
Switches the X-Y waveform display between the single and quad screen display.

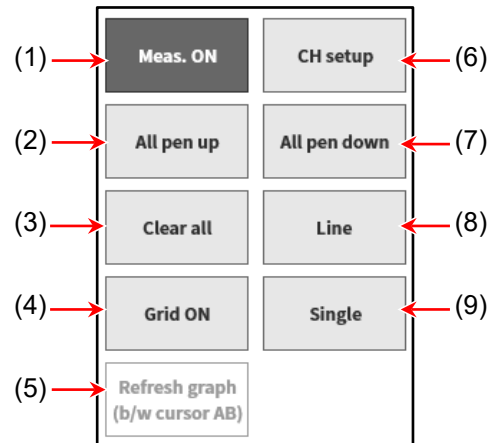

X-Y waveform channel setup procedure

- Step 1. Waveform selection
Selects waveforms X-Y1 to X-Y4.
When a waveform is tapped it is highlighted and its state is displayed in the channel table.
- Step 2. Axis selection
Select the X axis or Y axis.
When an axis is tapped, the channel specified for that axis is highlighted and the display changes to [ON].
[X axis] or [Y axis] is displayed for the channel already set for the other axis.
- Step 3. Channel selection
Select the channel.
Tap the channel to set and enable it.
- Step 4. When the settings are complete, tap [←] or [x] on the top title bar to return to the original X-Y waveform display.

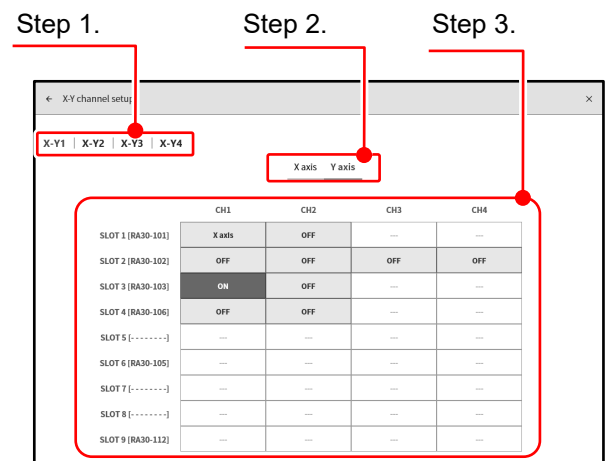

7.4. FFT Analysis

Data recorded with the following conditions can be used to perform FFT analysis if **【FFT】** is selected as the waveform format in the control bar. Two types of FFT analysis can be performed at the same time: Analysis1 and Analysis2.

The FFT analysis technology is described in "10.4. FFT Analysis."

FFT Analysis

Recording device: SSD
 Sampling speed: 1 MS/s or lower
 Data format: NORMAL
 Analog input amp: 1 channel or 2 channel

(1) Analysis switch

Switches the analysis results display between Analysis1 and Analysis2.

Switch the display by tapping the **【<】** and **【>】** key on the left or right of the analysis or swiping the analysis results area to the left or right.

(2) Meas. ON/OFF

Enables/disables the execution of FFT analysis.

(3) FFT setup

Tap this key to switch to the FFT setup screen to configure the FFT analysis conditions.

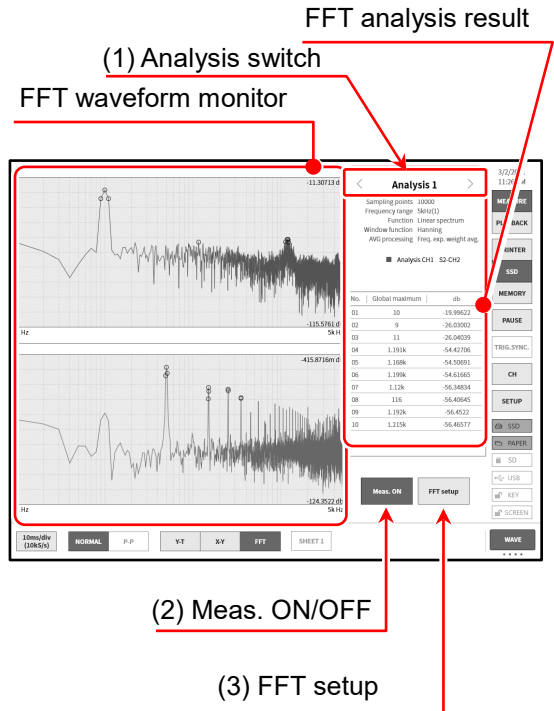

FFT setup

When the settings are complete, tap the **【←】** key or **【X】** on the top title bar to return to the original FFT analysis display.

Common settings

Analysis settings

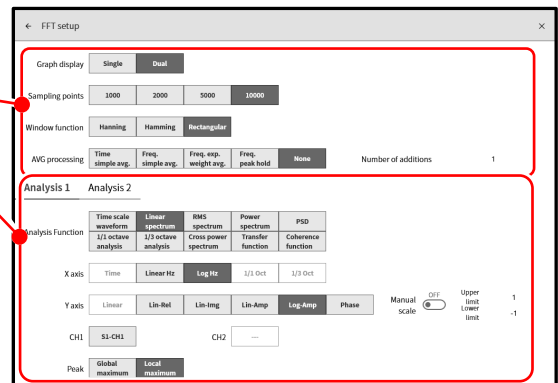

Common settings

Graph display: Select to overlay the analysis waveforms over one screen **【Single】** or display them separately on two screens **【Dual】**.

Sampling points: Select the sampling points for analysis. More sampling points means higher resolution for the analysis frequency.

Window function: Select the window function for analysis. Change the setting according to the state of the input signal.

AVG processing: Specify the type of averaging for the analysis results and the number of additions for the averaging.

Analysis settings

- Analysis selection: Select Analysis1 or Analysis2.
- Analysis Function: Select Analysis1 or Analysis2. The X axis, Y axis, and CH selection are limited by the analysis type. Available setting keys are brighter.
- X axis: Sets the X axis of the analysis waveform.
- Y axis: Sets the Y axis of the analysis waveform. When manual scaling is disabled, the Y axis is automatically set based on the analysis results. When enabled, the upper limit value and lower limit value of the Y axis scale can be set manually.
- Channel setting: Sets the target channel for analysis. 【Time scale waveform】 to 【1/3 octave】 in the analysis types are settings only for channel 1 with one channel analysis, and 【Cross power spectrum】 to 【Coherence function】 are settings for channel 1 and channel 2 with two channel analysis.
- Peak: Extracts the global maximum or local maximum from the analysis results and displays the top 10 points in the results.

7.5. Search Function

The search function searches for recorded data with the specified search conditions and displays the S mark (search  mark) and the waveform near the results on the Y-T waveform.

7.5.1. Search Types and Operations

The following five types of searches are available.

- Peak value search: Searches for the maximum, minimum, local maximum, and local minimum
- Level search: Searches for conditions above or below the specified threshold
- Window search: Searches inside (IN) or outside (OUT) the specified upper/lower limit range
- Trigger point search: Searches for the recorded trigger point
- Mark point search: Searches for the recorded mark point

Search Procedure

- Step 1. Perform the procedure in "7.1. Select Recorded Data."
- Step 2. Tap the 【CH】 key on the [side menu](#) to display the channel setup sub menu.
- Step 3. Tap the 【Tools】 tab.



- Step 4. The following two types of search setting operations are available.
 - If the [side menu](#) for search settings is not displayed, swipe near the green frame to display it.
 - Type 1: For a pull-down list, tap the 【target settings】 key, and tap Item in the list.

Type 2: For numeric entry, tap the **【target settings】** key to change the frame to orange. The area around the rotary knob turns blue, and the rotary knob can be used to change the setting.

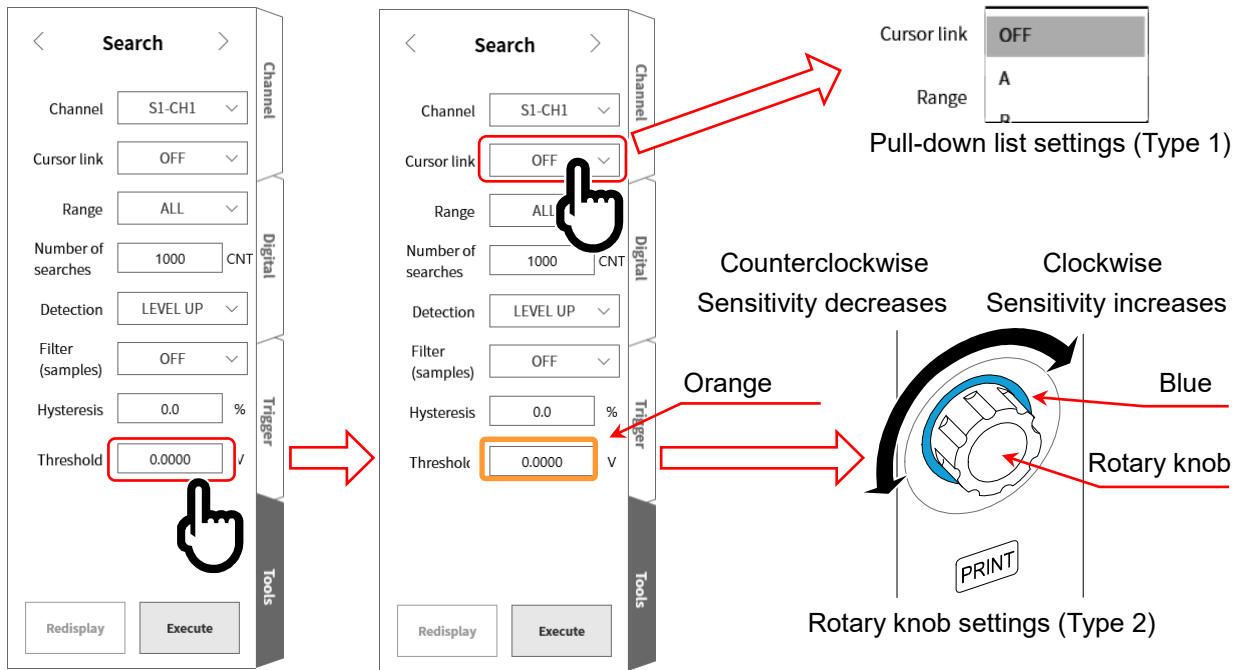

Step 5. When the settings are complete, tap the **【Execute】** key. The search starts, and when the search is complete, the S mark and the waveform near the results are displayed on the Y-T waveform, and the **side menu** switches to the "7.5.10. Search Display Menu." The display position of the S mark changes according to the display position of the search results. If the search is canceled, the incomplete results are displayed and the S mark is displayed in the center.



Step 6. When there are one or more search results, press the **【<】** key (back)/**【>】** key (forward) in the "7.5.10. Search Display Menu" to change the waveform display. You can press the **【CH】** key to return to the channel setup sub menu and reset the search conditions. Press the **【Close search】** key to return from the "7.5.10. Search Display Menu" to the basic **side menu**.

7.5.2. Search Method Types and Settings

The settings differ for each search method (the **Detection** setting (main unit screen notation)).

"Yes" in the table below indicates a setting available for the corresponding search method.

When the search channel is analog channel data								
Detection (search method)	Cursor link	Range	Number of searches	Filter	Hysteresis	Threshold	Upper threshold	Lower threshold
MAXIMUM	Yes	Yes	Yes					
MINIMUM	Yes	Yes	Yes					
MAXIMAL	Yes	Yes	Yes	Yes				
MINIMAL	Yes	Yes	Yes	Yes				
LEVEL UP	Yes	Yes	Yes	Yes	Yes	Yes		
LEVEL DOWN	Yes	Yes	Yes	Yes	Yes	Yes		
INTO WIN	Yes	Yes	Yes	Yes	Yes		Yes	Yes
OUT WIN	Yes	Yes	Yes	Yes	Yes		Yes	Yes

When the search channel is logic channel data					
Detection (search method)	Cursor link	Range	Number of searches	Filter	Bit pattern
BIT OR	Yes	Yes	Yes	Yes	Yes
BIT AND	Yes	Yes	Yes	Yes	Yes

When the search channel is disabled			
Detection (search method)	Cursor link	Range	Number of searches
Trigger	Yes	Yes	Yes
Mark	Yes	Yes	Yes

Conditions where searching cannot be performed

Searches cannot be performed with the following conditions. (The **Execute** key is disabled.)

- For "Mode"
- For "X-Y Display"
- For "FFT Display"
- When memory recording or search detection is set to "Mark"
- When the search channel is the logic module and "[10.1.2. P-P Sampling](#)"

Conditions for redisplay

The **Redisplay** key is enabled when a search has been executed.

The redisplay function displays the same results as the results after search execution.

The search results are cleared when one of the following operations are performed. The search results cannot be redisplayed after they are cleared.

- When the **Execute** key is tapped to start search execution
- When the **Next search** key is tapped to start search execution
- When replay data is selected ("[7.1. Select Recorded Data](#)")
- When replay data is deleted (when the recorded data is deleted in "[8.2.1. Record management](#)")

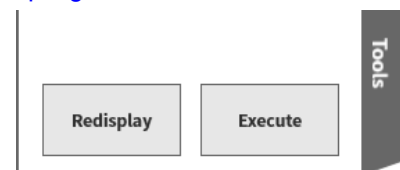

Search setup menu

This section provides examples of settings. For information on the method for displaying the search setup menu, see "7.5.1. Search Types and Operations."

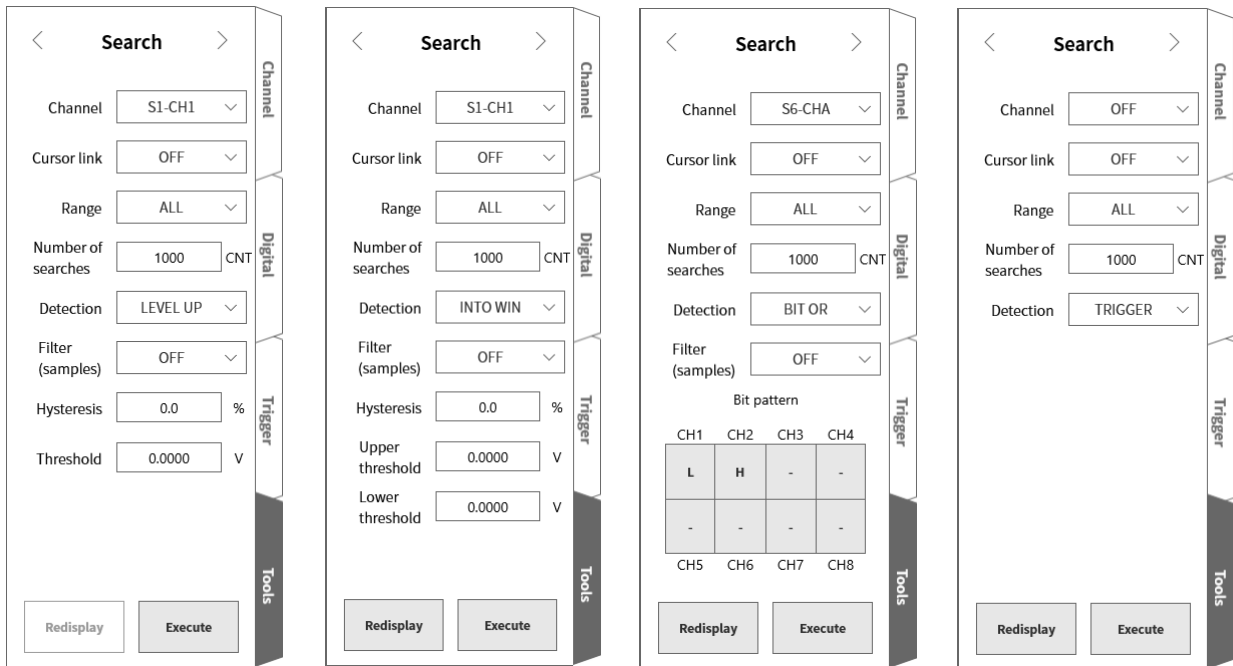

Channel: Select the channel to search.

Cursor link: Select OFF, A, or B.

OFF Do not link with the cursor.

A Move (link) Cursor A to the S mark line.

B Link with Cursor B.

When the cursor link setting is "B", the jump destination is "CURSOR", and the cursor setting is "A", Cursor B moves to the same point as Cursor A.

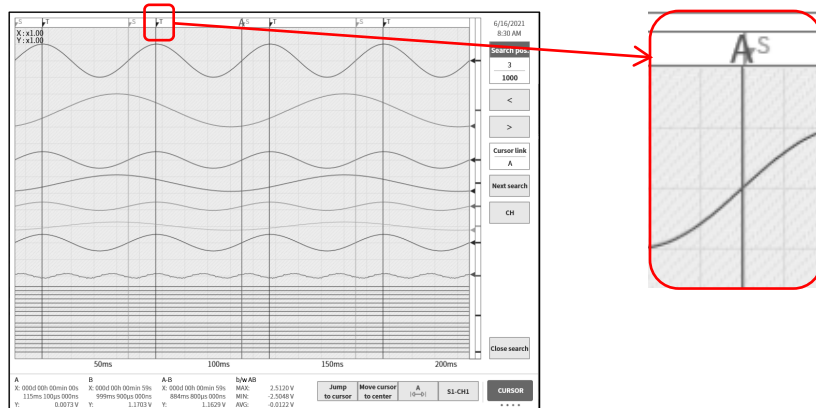

Range: Select All or B/W CURSOR.

All All the recorded data is the target and the number of detection results is 1,000.

Cursor A moves to the point of the search result where Cursor A is first, according to the cursor link set to A.

B/W CURSOR The data between A and B is the target and the number of detection results is 1.

Cursor A moves to the point where the search result is Cursor A, according to the cursor link set to A.



The cursor line display must have the "1.6.2. Control Bar" as the 【CURSOR】 key. See "7.2.3. Cursor" for the cursor settings.

B/W CURSOR (setting before search execution)

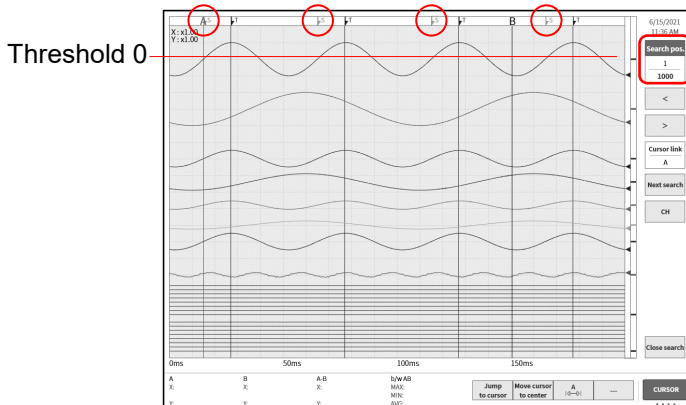

For [ALL]

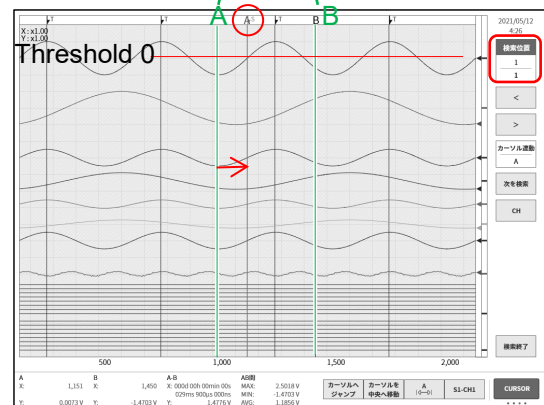

For [B/W CURSOR]

The figure above is the search result when the search setting is LEVEL UP and the threshold is set to 0.

The search is executed for the topmost sine wave (1,000 waves or more).

The cursor A-B setting is set to approximately one sine wave, as indicated in the figure above.

The red circle ○ on the top of the image is the S mark indicating the search results.





- Number of searches: Set the maximum number. The search stops when the number of search results exceeds the value set here.
- Filter: See "Peak Value Search (Local Maximum/Local Minimum)", "7.5.5. Level Search (LEVEL UP/LEVEL DOWN)" and "7.5.6. Window Search (INTO WIN/OUT WIN)".
- Hysteresis: See "7.5.5. Level Search (LEVEL UP/LEVEL DOWN)" and "7.5.6. Window Search (INTO WIN/OUT WIN)".
- Threshold: See "7.5.5. Level Search (LEVEL UP/LEVEL DOWN)".
- Upper threshold: See "7.5.6. Window Search (INTO WIN/OUT WIN)".
- Lower threshold: See "7.5.6. Window Search (INTO WIN/OUT WIN)".

7.5.3. Peak Value Search (Maximum/Minimum)

The maximum value or minimum value of the set range is searched.

If there are multiple of the same maximum or minimum values, the first point is displayed.

7.5.4. Peak Value Search (Local Maximum/Local Minimum)

- The detection point is the local maximum  when larger than two adjacent samples or the local minimum  when smaller than two adjacent samples. The detection point also occurs if the next value is the same as the local maximum  or the next value is the same as the local minimum .
- For "10.1.2. P-P Sampling", the maximum data is searched for the local maximum and the minimum data is searched for the local minimum.
The local maximum/local minimum search function has a filter and the filter length can be set within the following range.
Filter: OFF, 10, 20, 50, 100, 200, 500, 1000, 2000, 5000, or 10000.

Filter role and methodology

- When the filter is set to 10 (samples), 10 samples before and after are searched, for a total search range of 21 samples.
 $X^{n-10}, X^{n-9}, \dots, X^n, X^{n+1}, \dots, X^{n+10}$
If multiple local maximums or local minimums exist in these 21 samples, x^n is the detection point if x^n is the largest local maximum or the smallest local minimum. If a sample other than x^n is the local maximum or local minimum, it is not deemed to be the local maximum or local minimum.
An amount of sample data from the detection point equal to the filter setting is not subject to search, and searching starts from the next sample data, x^{n+1} .
- If there is no sample data equal to the length of the filter before and after the search point, that detection point is disabled. When the filter is set to 10 (samples), searching is performed from the 11th item of sample data.
If there is no sample data equal to the length of the filter near the end of the search range, that detection point is disabled.
- When the filter setting is disabled, the operation is the same as when the filter is set to 1, which means that all the sample data that meets the above conditions become detection points. See "Search example 1" and "Search example 2".
- When the filter is set to 10 (samples), 10 samples before and after are searched, for a total search range of 21 samples. If a target sample point is a local maximum and the largest local maximum within the range, it becomes the detection point. If a sample point is a local minimum and the smallest local minimum within the range, it becomes the detection point. If a local maximum with the same value or multiple local minimums exist in the range, they become detection points. If there is no sample data equal to the length of the filter before and after the target sample point within that range, that detection point is disabled. See "Search example 3" and "Search example 4".

Search example 1

All local maximum points or local minimum points are the detection points.

Because there is no data before the first sample, it will not be a local minimum. The last sample will also not be a local maximum.

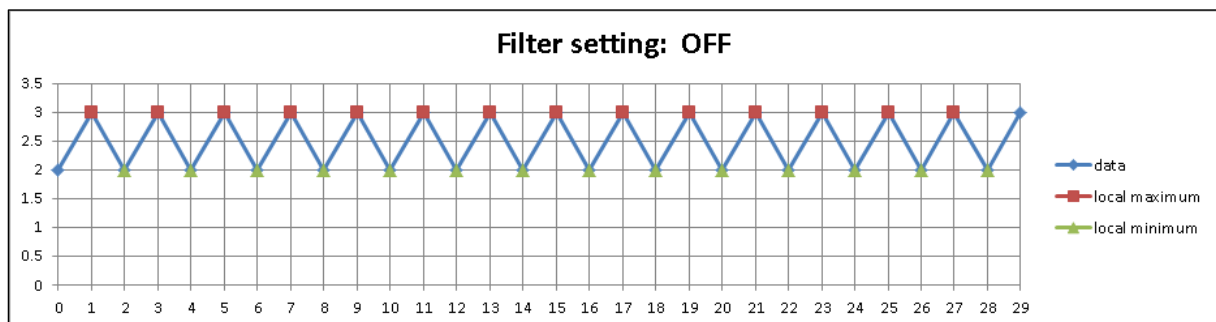

Search example 2

The local maximum and local minimum markers are the detection points.

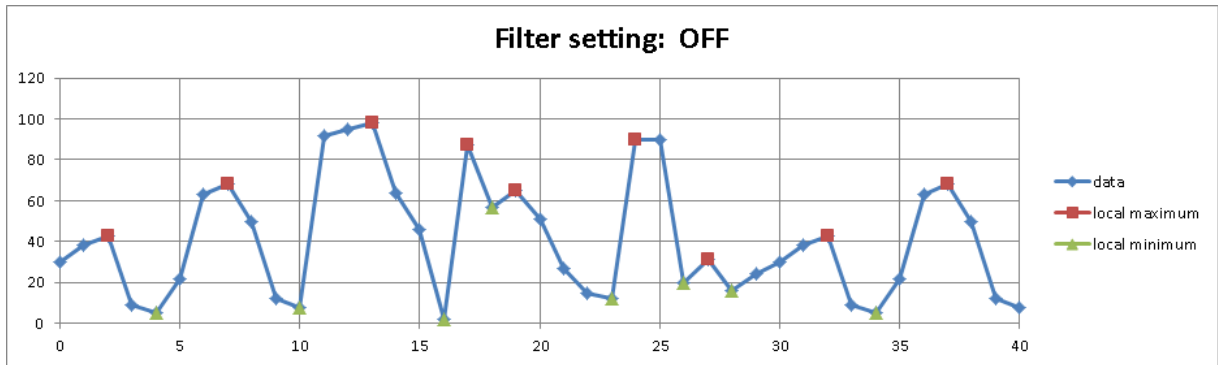

Search example 3

The red circle point is not subject to the search because there are only nine previous samples.

Because the local maximums are valid from the 11th item of sample data, those local maximums are the detection points.

The 13th, 15th, 17th, 19th, and 21st items of sample data are not deemed to be local maximums due to filtering.

There are no detection points from the 22nd item of data, because there is no data of the filter length after that point.

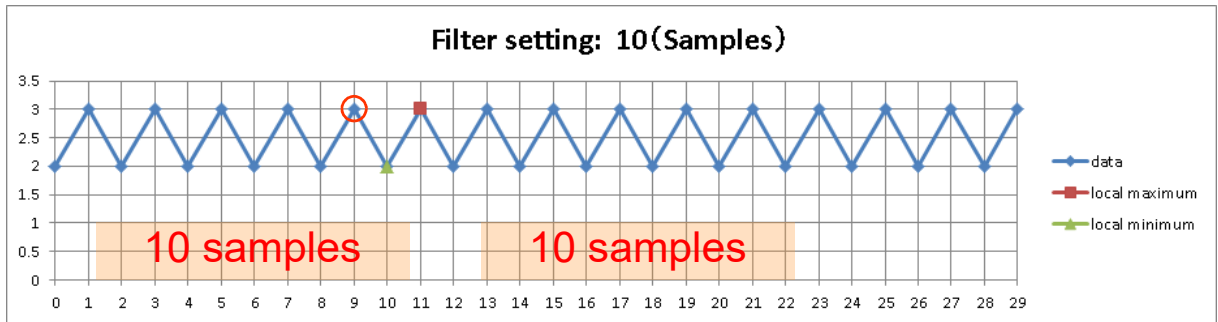

Search example 4

The local maximum and local minimum markers are the detection points.

The red circle will not be a detection point. This is because there is no data of the filter length after that point.

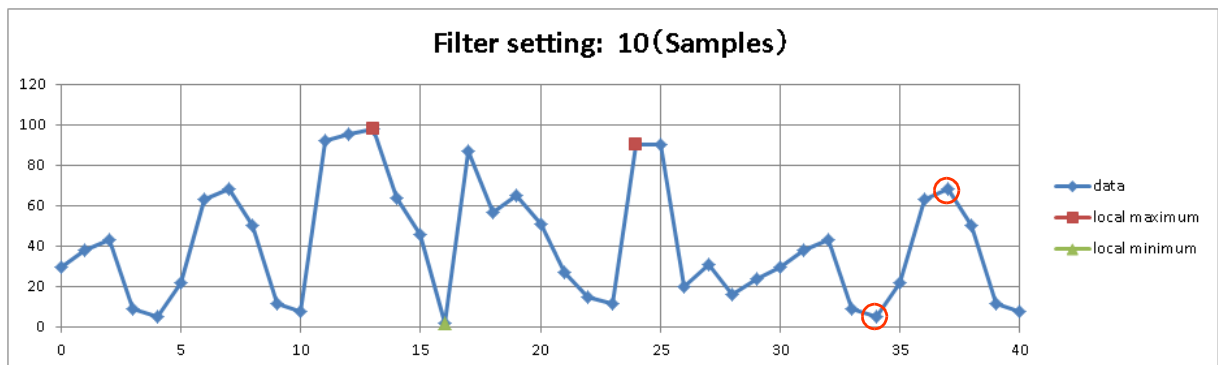

7.5.5. Level Search (LEVEL UP/LEVEL DOWN)

□ Level search with "10.1.1. NORMAL Sampling"

When LEVEL UP is set, the samples where the condition $\text{threshold} < \text{data value}$  is met are the detection points.

When LEVEL DOWN is set, the samples where the condition $\text{threshold} > \text{data value}$  is met are the detection points.

Level search after point detection

When LEVEL UP is set, the next detection is not performed until the condition

$\text{data value} < \text{threshold} - \text{hysteresis}$ is met.

When LEVEL DOWN is set, the next detection is not performed until the condition

$\text{data value} > \text{threshold} + \text{hysteresis}$ is met.

□ Level search with "10.1.2. P-P Sampling"

When LEVEL UP is set, the samples where the condition $\text{threshold} < \text{maximum data value}$ is met are the detection points.

When LEVEL DOWN is set, the samples where the condition $\text{threshold} > \text{minimum data value}$ is met are the detection points.

Level search after point detection

When LEVEL UP is set, the next detection is not performed until the condition

$\text{maximum data value} < \text{threshold} - \text{hysteresis}$ is met.

When LEVEL DOWN is set, the next detection is not performed until the condition

$\text{minimum data value} > \text{threshold} + \text{hysteresis}$ is met.

□ The function is waiting for detection immediately after a level search starts.

The level search function has hysteresis and filter settings.

Filter: OFF, 10, 20, 50, 100, 200, 500, 1000, 2000, 5000, or 10000.

The detection point is the sample after the conditions are established continuously for the set filter length from the point where the search conditions are met.

When LEVEL UP is set, the detection condition is $\text{data value} \geq \text{threshold} - \text{hysteresis}$.

When LEVEL DOWN is set, the detection condition is

$\text{minimum data value} \leq \text{threshold} + \text{hysteresis}$.

See "LEVEL UP search example 2".

The above is for normal recording. For "10.1.2. P-P Sampling", the data value that meets the above condition is the maximum data value or minimum data value.

OFF has the same meaning as 1.

Hysteresis: 0.0 to 10.0%, in increments of 0.1

The ratio to the measurement range.

When set to 0.1% and the range is 10 V, the hysteresis is 10 mV.

LEVEL UP search example 1

This section is an example of when LEVEL UP is set and filtering is disabled. The ■ marker is the detection point and the ○ red circle is the detection restart point.

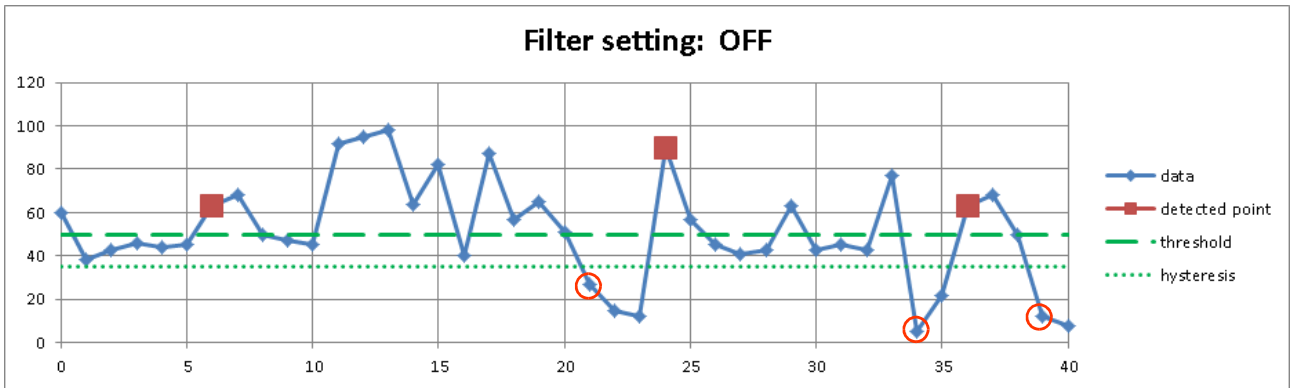

LEVEL UP search example 2

This section is an example of when LEVEL UP is set and filtering is set to 10. The ■ marker is the detection point.

The data is the same as "LEVEL UP search example 1". The first detection point of "LEVEL UP search example 1" is the 6th sample, and the next detection point that meets the detection conditions is the 15th sample (after the 10 point filter).

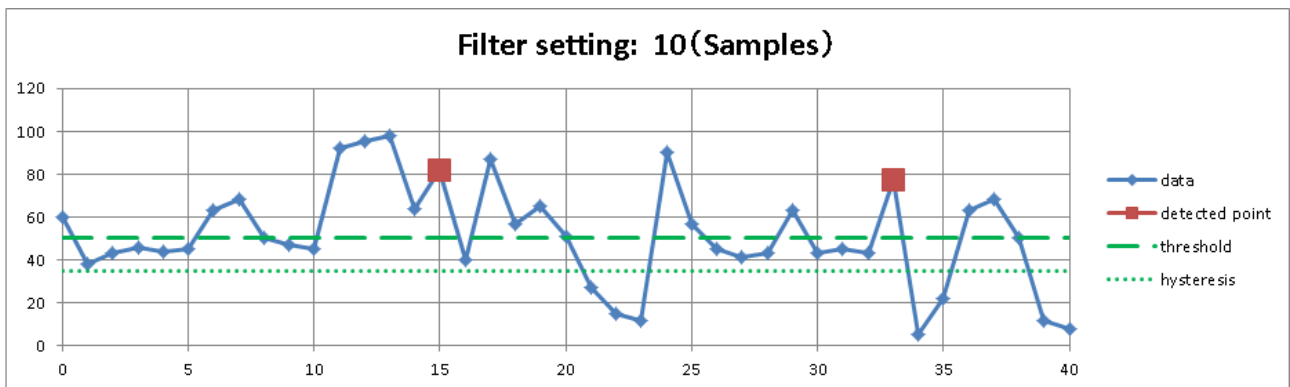

LEVEL DOWN search example 1

This section is an example of when LEVEL DOWN is set and filtering is disabled. The ▲ marker is the detection point and the ○ red circle is the detection restart point.

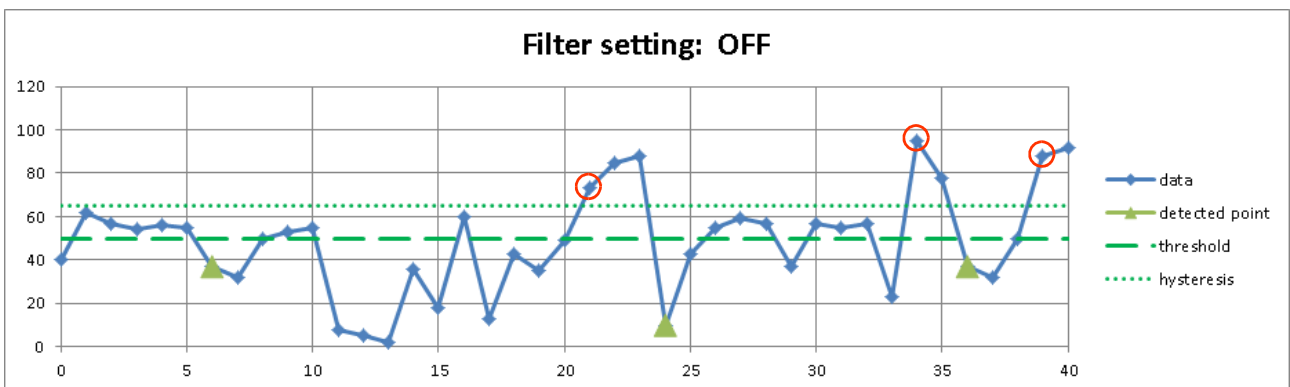

LEVEL DOWN search example 2

This section is an example of when LEVEL DOWN is set and filtering is set to 10. The ▲ marker is the detection point.

The data is the same as "LEVEL DOWN search example 1". The first detection point of "LEVEL DOWN search example 1" is the 6th sample, and the next detection point that meets the detection conditions is the 15th sample (after the 10 point filter).

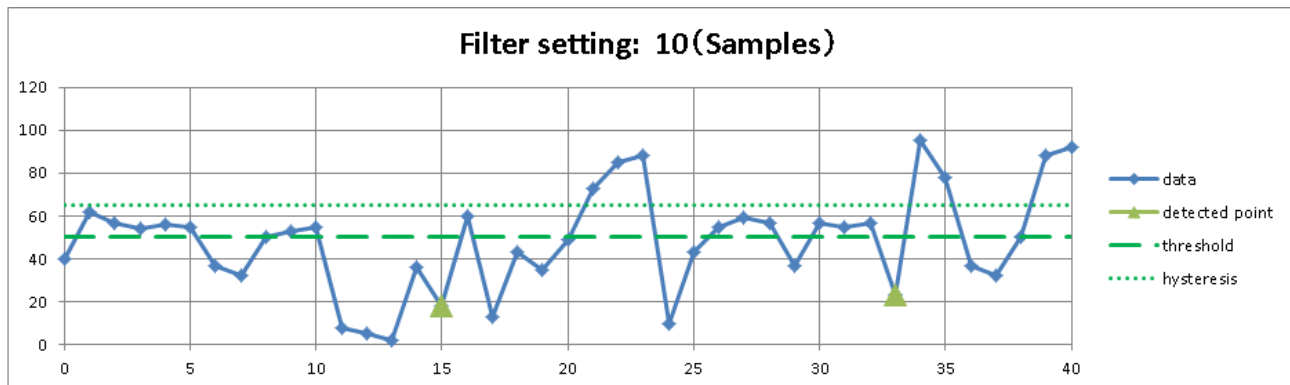

7.5.6. Window Search (INTO WIN/OUT WIN)

- Window search with "10.1.1. NORMAL Sampling"

When INTO WIN is set, the samples where the condition $\boxed{\text{lower threshold} < \text{data value} < \text{upper threshold}}$ is met are the detection points.

When OUT WIN is set, the samples where the condition $\boxed{\text{lower threshold} > \text{data value}}$ or $\boxed{\text{data value} > \text{upper threshold}}$ is met are the detection points.

Window search after point detection

When INTO WIN is set, the next detection is not performed until the condition $\boxed{\text{data value} < \text{lower threshold} - \text{hysteresis}}$ or $\boxed{\text{upper threshold} + \text{hysteresis} < \text{data value}}$ is met.

When OUT WIN is set, the next detection is not performed until the conditions $\boxed{\text{data value} > \text{lower threshold} + \text{hysteresis}}$ and $\boxed{\text{upper threshold} - \text{hysteresis} > \text{data value}}$ are met.

- Window search with "10.1.2. P-P Sampling"

When INTO WIN is set, the samples where the conditions $\boxed{\text{lower threshold} < \text{maximum data value}}$ and $\boxed{\text{minimum data value} < \text{upper threshold}}$ are met are the detection points.

When OUT WIN is set, the samples where the condition $\boxed{\text{lower threshold} > \text{minimum data value}}$ or $\boxed{\text{maximum data value} > \text{upper threshold}}$ is met are the detection points.

Window search after point detection

When INTO WIN is set, the next detection is not performed until the condition $\boxed{\text{maximum data value} < \text{lower threshold} - \text{hysteresis}}$ or $\boxed{\text{upper threshold} + \text{hysteresis} < \text{minimum data value}}$ is met.

When OUT WIN is set, the next detection is not performed until the conditions $\boxed{\text{minimum data value} > \text{lower threshold} + \text{hysteresis}}$ and $\boxed{\text{upper threshold} - \text{hysteresis} > \text{maximum data value}}$ are met.

7.Playback Recorded Data – 7.5.Search Function

- The function is waiting for detection immediately after a window search starts.
The window search function has hysteresis and filter settings.

Filter: OFF, 10, 20, 50, 100, 200, 500, 1000, 2000, 5000, or 10000.

The detection point is the sample after the conditions are established continuously for the set filter length from the point where the search conditions are met.

When INTO WIN is set, the detection conditions are

$\text{data value} \geq \text{lower threshold} - \text{hysteresis}$ and
 $\text{upper threshold} + \text{hysteresis} \geq \text{data value}$.

When OUT WIN is set, the detection condition is

$\text{data value} \leq \text{lower threshold} + \text{hysteresis}$ or
 $\text{upper threshold} - \text{hysteresis} \leq \text{data value}$.

See "INTO WIN search example 2". The above is for normal recording. For "10.1.2. P-P Sampling", the data value that meets the above condition is the maximum data value or minimum data value. OFF has the same meaning as 1.

Hysteresis: 0.0 to 10.0%, in increments of 0.1

The ratio to the measurement range.

When set to 0.1% and the range is 10 V, the hysteresis is 10 mV.

INTO WIN search example 1

This section is an example of when INTO WIN is set and filtering is disabled. The ■ marker is the detection point and the ○ red circle is the detection restart point. The blue circle ○ on the 17th item of data is not a detection point. The sample data value of the 16th item of data does not enter detection standby because it is the same value as hysteresis.

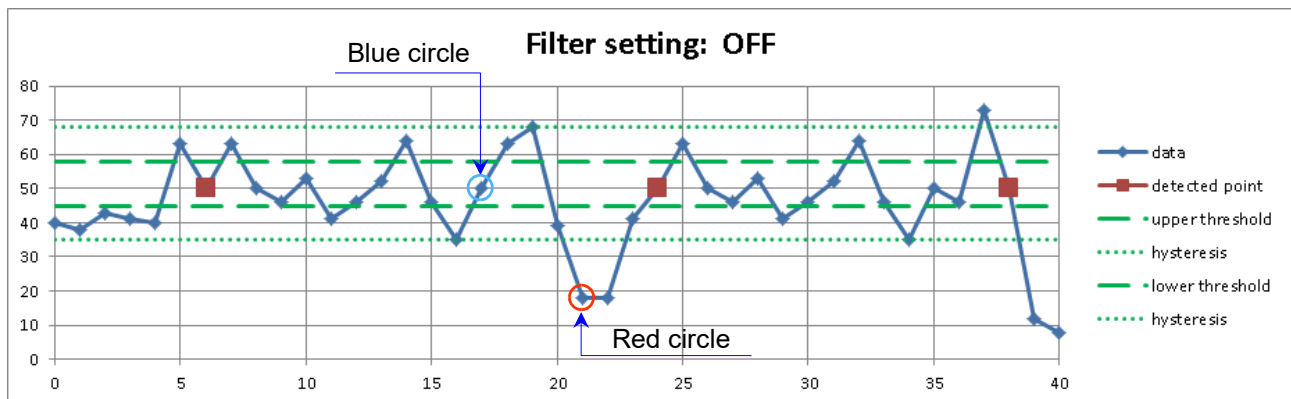

INTO WIN search example 2

This section is an example of when INTO WIN is set and filtering is set to 10. The ■ marker is the detection point. The data is the same as "INTO WIN search example 1". The first detection point of "INTO WIN search example 1" is the 6th sample, and the next detection point that meets the detection conditions is the 15th sample (after the 10 point filter).

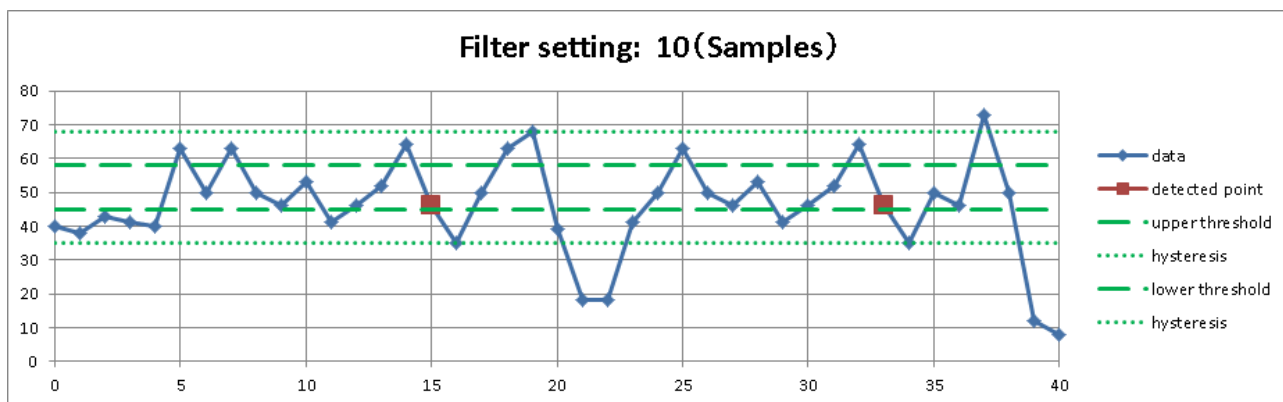

OUT WIN search example 1

This section is an example of when OUT WIN is set and filtering is disabled. The ■ marker is the detection point and the ○ red circle is the detection restart point.

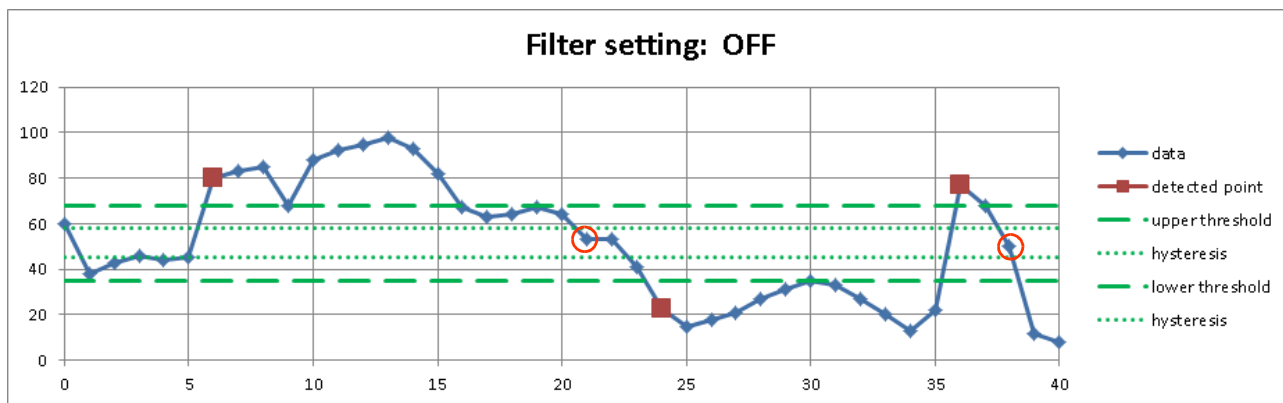

OUT WIN search example 2

This section is an example of when OUT WIN is set and filtering is set to 10. The ■ marker is the detection point.

The data is the same as "OUT WIN search example 1". The first detection point of "OUT WIN search example 1" is the 6th sample, and the next detection point that meets the detection conditions is the 15th sample (after the 10 point filter).

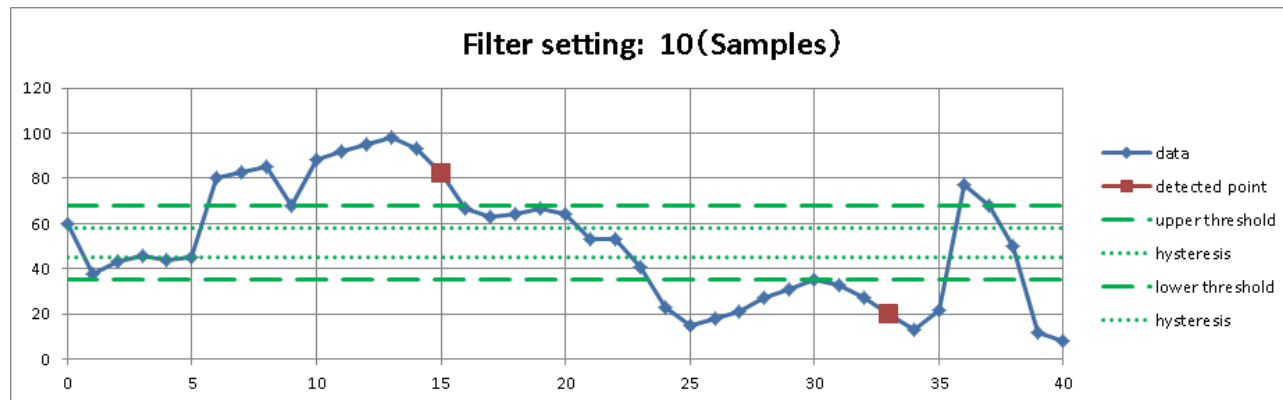

7.5.7. Logic Search

- When channels are set for a logic module in the (search) channel settings, the settings of the logic search conditions are displayed.
- A single logic module is 16 channels (16 bits).
The channels are divided into two groups (Channel A and Channel B), with CH1 to CH8 corresponding to Channel A and the rest corresponding to Channel B.
The detection points are the samples where the AND or OR operation in each group can be performed and the setting conditions are met.
- The input values immediately after starting the search are ignored, even if the conditions are established. The search starts after the data value changes.
- * Searches cannot be performed with "10.1.2. P-P Sampling". See "Conditions where searching cannot be performed" in "7.5.2. Search Method Types and Settings".

Bit pattern: - (OFF: Disabled)/L (Low level)/H (High level)
Set the logic establishment conditions for each of the eight logic channels.

Detection: BIT AND/BIT OR

BIT AND The detection points are the samples where all the channels set in "Bit pattern" meet the conditions.

BIT OR The detection points are the samples where any of the channels set in "Bit pattern" meet the conditions.

Filter: OFF, 10, 20, 50, 100, 200, 500, 1000, 2000, 5000, or 10000.
The detection point is the sample after the conditions are established continuously for the set filter length from the point where the search conditions are met.
OFF has the same meaning as 1.

Logic search example (BIT AND)

The screen is an example of the BIT AND conditions (Y-T waveform display in execution results).
The logic waveform is S1-CHA, the same as the search channel.
The top waveform on the screen displays CH1 and the bottom waveform displays CH8.
We can see that a search has been performed using the "Bit pattern" condition in the settings.

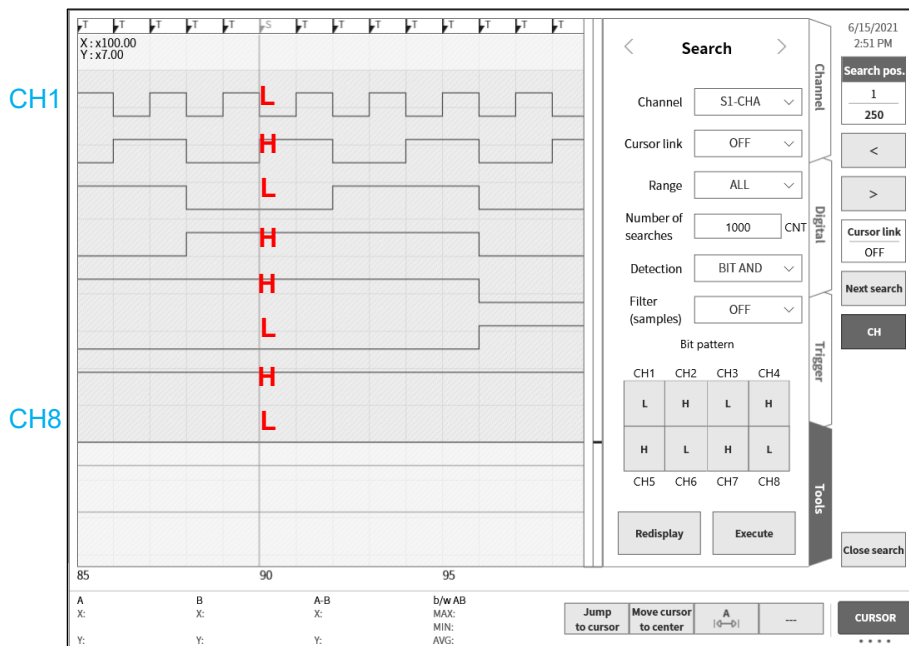

7.5.8. Trigger Search

Searches for the trigger points (T mark  on the top of the Waveform monitor) detected in "5. Trigger Setup" during recording.

- * For a trigger, the S mark on the Y-T waveform is not displayed.

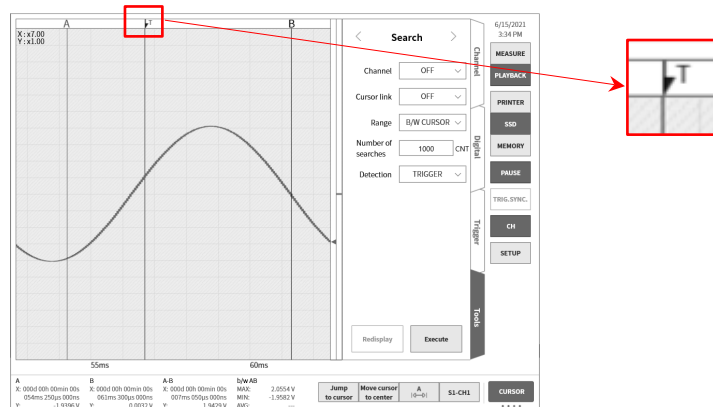

7.5.9. Mark Search

Searches for the detection points (M mark  on the top of the Waveform monitor) of the MARK signal in "12.3.6. Remote Control Module (RA30-112)" during recording. For details on the detection points of the MARK signal, see "9.6.6. Reference Materials".

- * For a mark, the S mark on the Y-T waveform is not displayed.
- * A mark search cannot be performed for memory recording. See "Conditions where searching cannot be performed" in "7.5.2. Search Method Types and Settings".

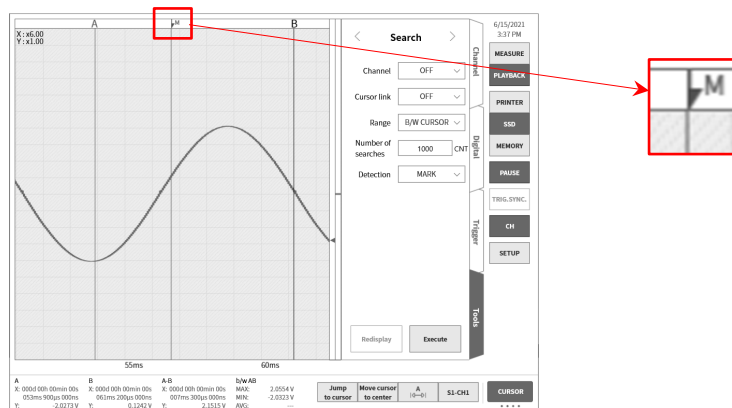

7.5.10. Search Display Menu

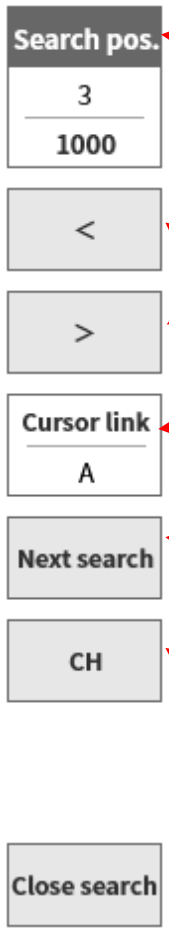

(1) Current number and total number of search results, and the search results themselves
Displays the number of the search result that is currently being displayed on the top and the total number of search results on the bottom. For information on changing the search results display, see ["Method for changing the search results display"](#).

(2) Operation keys for changing the search results display
For information on changing the search results display, see ["Method for changing the search results display"](#).

(3) Cursor link
OFF/A/B
See ["Search setup menu"](#). The operation is the same as that cursor link.

(4) Next search
If more search results exist than the search upper limit, searching is performed again with the last point of the search results as the start point of the search range. The previous search results are deleted when the key is pressed.

(5) Check or reset search settings
Tap the **[CH]** key to display ["4.2.1. Channel setup sub menu \(for RA30-101\)"](#) to check or reset the search settings.

(6) Close search
Tap the **[Close search]** key to end the search and return the search display menu to the regular [side menu](#).

Function limitations

The following functions cannot be used while this menu is displayed.

- Switching the recorded data (between printer recording, SSD recording, and memory recording)
- Switching the memory block
- Switching the X-Y display and FFT display

Method for changing the search results display

There are three methods for displaying the search results.

When the search result number is changed, the Y-T waveform follows and the center of the screen becomes the detection point. However, if there is a detection point near the start or end of the recorded data, the center of the screen will not be the detection point because the maximum amount of waveform is displayed.

- Tap (1) to enable the jog dial.
The jog dial works in increments of 10 for the standard mode and increments of 1 for the fine adjustment mode.
For information on each mode, see ["1.3. Operation panel"](#).
- Press and hold (1) to set the numeric input dialog.
- Tap the **[<]** key in (2) to move to the previous result or the **[>]** key to move to the next result.

7.6. Jump Function

Set the following jump conditions to jump to the corresponding location. (The Y-T waveform display is updated.)

- BEGINNING: Jumps to the beginning of the recorded data
- CENTER: Jumps to the center of the recorded data
- END: Jumps to the end of the recorded data
- DATE: Jumps to the specified time
- TIME: Jumps to the specified elapsed time
- POINT: Jumps to the specified sample point
- CURSOR: Jumps to Cursor A or Cursor B

7.6.1. Jump Types and Operations

Step 1. Perform the procedure in "7.1. Select Recorded Data."

Step 2. Tap the **[CH]** key on the **side menu** to display the channel setup sub menu.

Step 3. Tap the **[Tools]** tab.

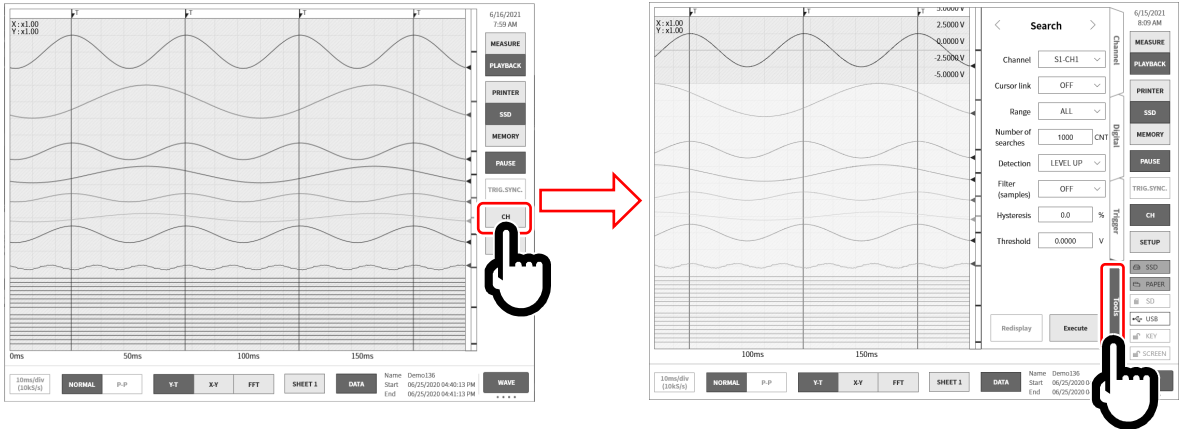

Step 4. There are two main methods for operating the settings.

If the **jump settings menu** is not displayed, swipe near the green frame.

Type 1: For a pull-down list, tap the **[target settings]** key, and tap Item in the list.

Type 2: For numeric entry, tap the **[target settings]** key to change the frame to orange. The area around the rotary knob turns blue, and the rotary knob can be used to change the setting.

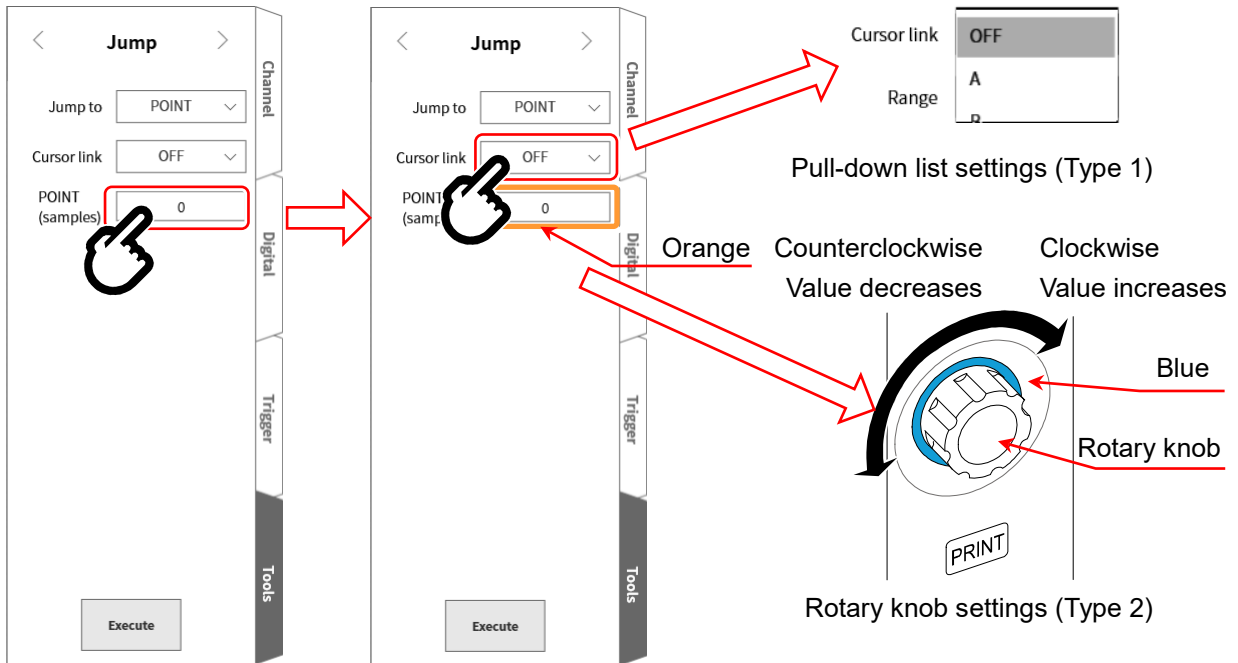

Step 5. When the settings are complete, tap the **[Execute]** key.

The process starts, the jump condition is displayed in the center of the Y-T waveform when the process finishes, then the **side menu** closes. If the search result is near the beginning or end of the data, the S mark will not be displayed in the center.

7.6.2. Jump Condition Types and Settings

The settings differ for each jump condition (the **Jump to** setting (main unit screen notation)). For details, see "7.6.3. Data beginning, center, end", "7.6.4. Date Setup", "7.6.5. Time Setup", "7.6.6. POINT(samples)", "7.6.7. Cursor".

Jump to:

Jump to	Setting item	Setting value
Beginning		
Center		
End		
DATE	Date/Time	Year, month, day, hour, minute, second, millisecond, microsecond, nanosecond
Time	Elapsed time	Day, hour, minute, second, millisecond, microsecond, nanosecond
Point	Sample number	0 to recorded data count - 1
Cursor	Cursor	A, B

Cursor link: Select OFF, A, or B.

- OFF Do not link with the cursor.
- A Move (link) Cursor A to the S mark.
- B Link with Cursor B. When the cursor link setting is "B", the jump destination is "CURSOR", and the cursor setting is "A", Cursor B moves to the same point as Cursor A.

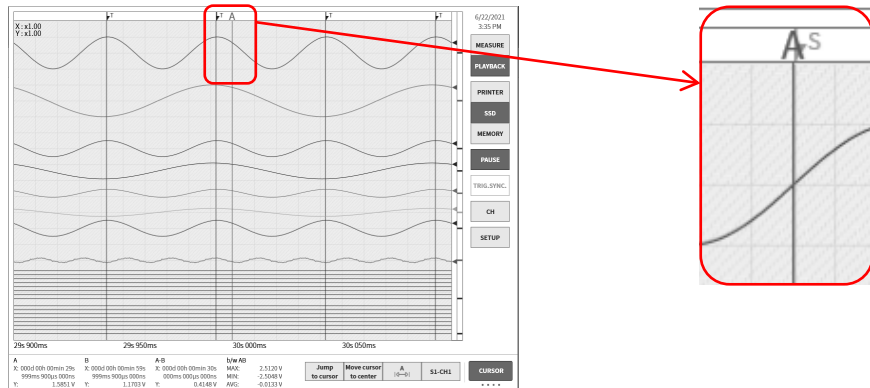

For Cursor A



The cursor line display must have the "1.6.2. Control Bar" as the **[CURSOR]** key. See "7.2.3. Cursor" for the cursor settings.

Jump setup menu

The screen on the right is an example of the jump setup menu.

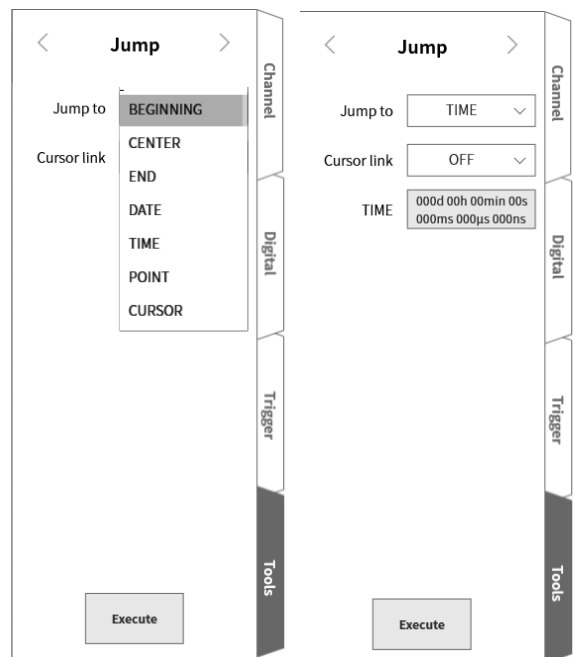

7.6.3. Data beginning, center, end

The THUMBNAIL waveform displays all data.
 The screen shows the result when CENTER is set.
 We can see that the center of the data displays the Y-T waveform.

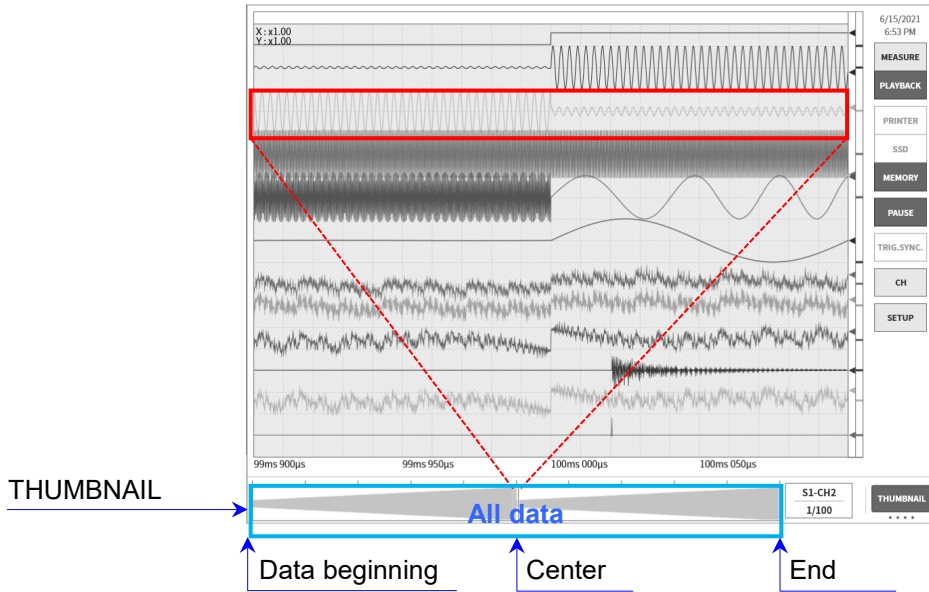

7.6.4. Date Setup

Tap the **【Execute】** key to jump to the point in "Date Setup".
 An error dialog is displayed if the setting is outside the recorded data range.
 If there is no data at the specified time, the most recent point is jumped to.



Use [X axis notation] in "8.2.6. Display Setup" as the **【Date】** key.

Date Setup

Tap the red frame to display the setup screen. Tap the date and set the year, month, and day by swiping, then tap the time and set the hour and minute by swiping. Tap the remaining second, millisecond, and microsecond, and nanosecond, and use the jog dial to specify the settings or press and hold to specify the settings on the numeric entry screen.

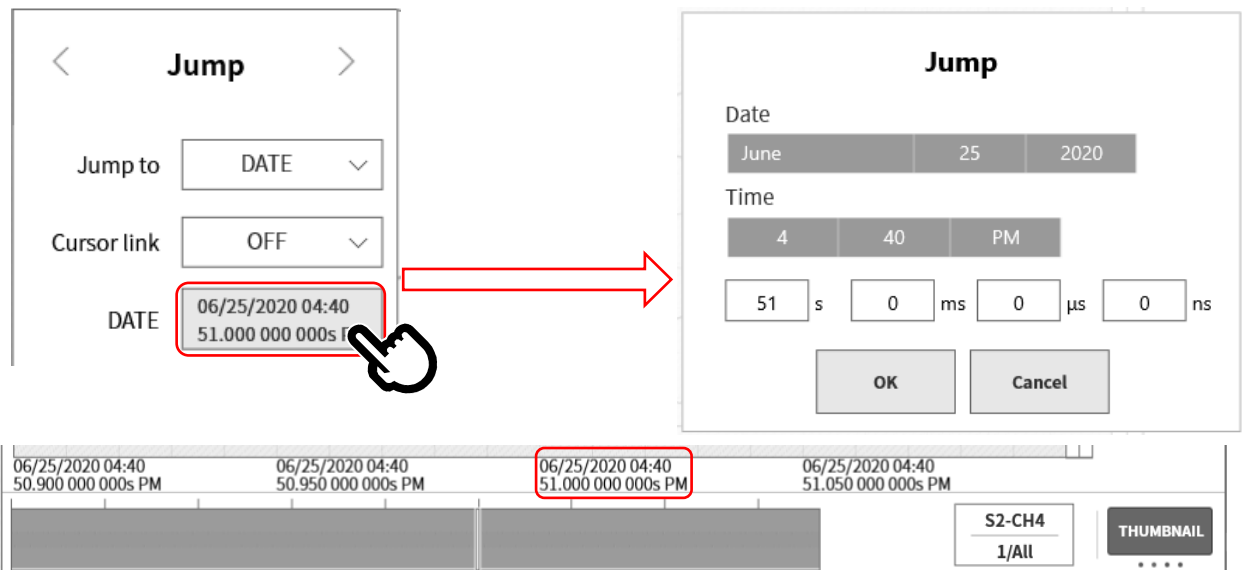

7.6.5. Time Setup

Tap the **【Execute】** key to jump to the point in "Time Setup". Set the relative time with the beginning of the recorded data as 0.

For memory recording, set the relative time with the beginning of the block as 0. All blocks are targeted. An error dialog is displayed if the setting is outside the recorded data range.

If there is no data at the specified time, the most recent point is jumped to.



Use [X axis notation] in "8.2.6. Display Setup" as the **【Time】** key.

Time Setup

Tap the red frame to display the setup screen. Tap the day, hour, minute, second, millisecond, and microsecond, and use the jog dial to specify the settings or press and hold to specify the settings on the numeric entry screen.

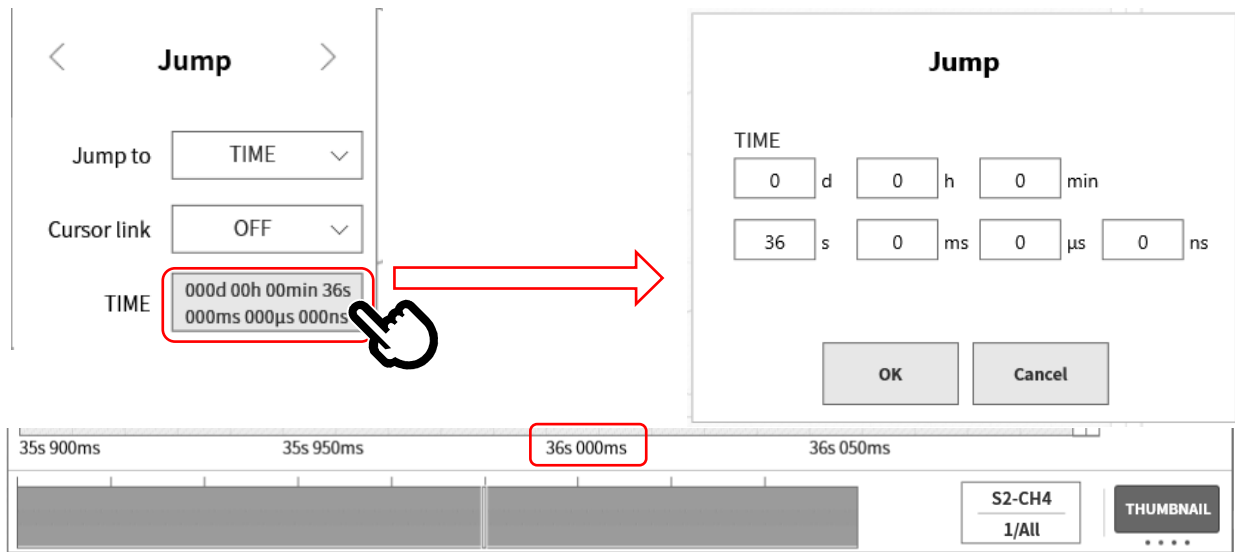

7.6.6. POINT(samples)

Tap the **【Execute】** key to jump to the point in "POINT(samples) Setup".



Use [X axis notation] in "8.2.6. Display" as the **【Point】** key.

POINT(samples) Setup

Tap POINT(samples) and use the jog dial to specify the settings or press and hold to specify the settings on the numeric entry screen.

Setting range: 0 to recorded sample count - 1

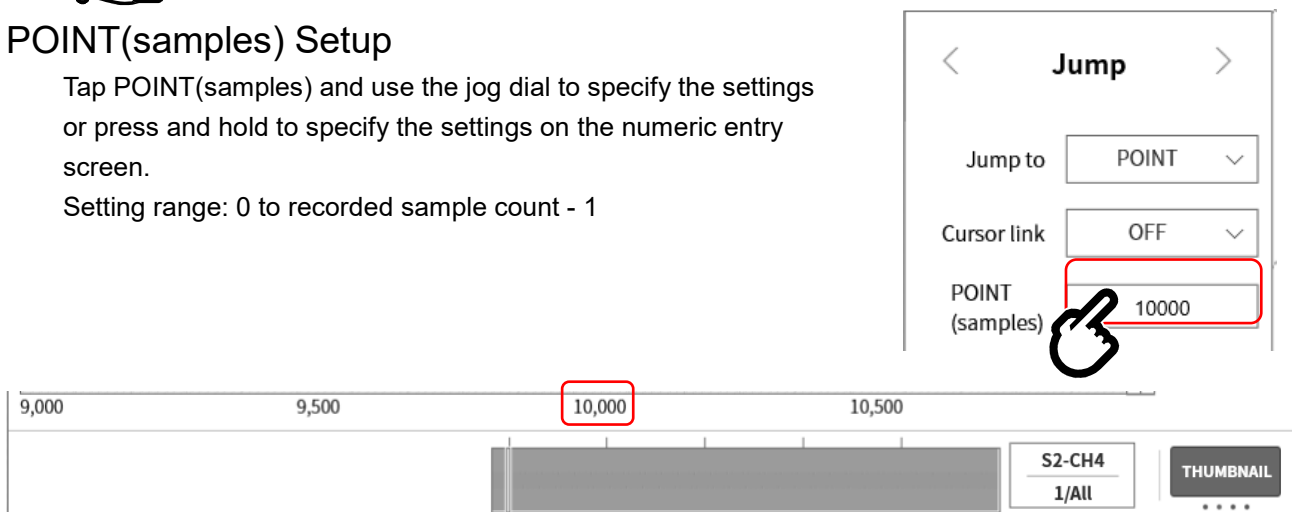

7.6.7. Cursor

Tap the **【Execute】** key to jump to the point in "Cursor Setup".



In "7.2.3. Cursor", set Cursor A or Cursor B.

Cursor Setup

Tap the cursor and use the jog dial to specify the settings or press and hold to specify the settings on the numeric entry screen.

Setting range: 0 to recorded sample count - 1

The screenshot shows the 'Jump' menu with 'CURSOR' selected in the 'Jump to' dropdown and 'OFF' in the 'Cursor link' dropdown. The 'CURSOR' section shows 'A' and 'B' options, with 'B' highlighted and a hand icon pointing to it. A red arrow points from the 'B' option to a numeric entry screen showing 'Cursor B time before jump execution' with the value '01s' highlighted in red.

Cursor B (time 1 s) is displayed in the center of the Y-T waveform.

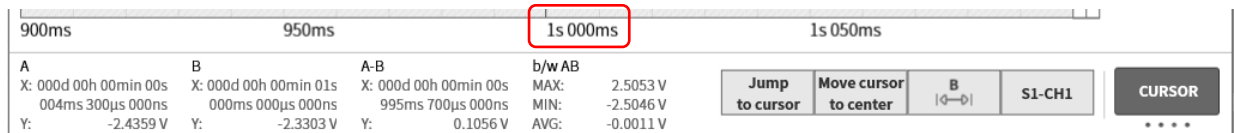

8. Setup Details

This chapter describes the function for configuring the various settings from Settings in the [side menu](#).

8.1. Recording Setup

Configure **Recording**, **Channel list**, **Sheet**, and **Printer**. Tap a settings category to display the detailed settings screen for that category.

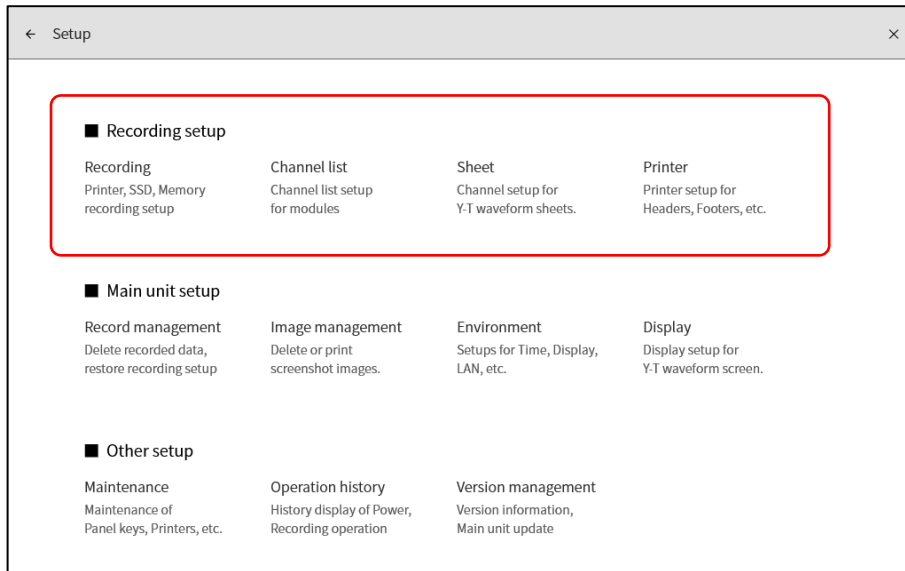

8.1.1. Recording

Tap Recording in the Recording setup to display a list of the settings related to recording. For details, see "[6.3.1. Recording Setup](#)".

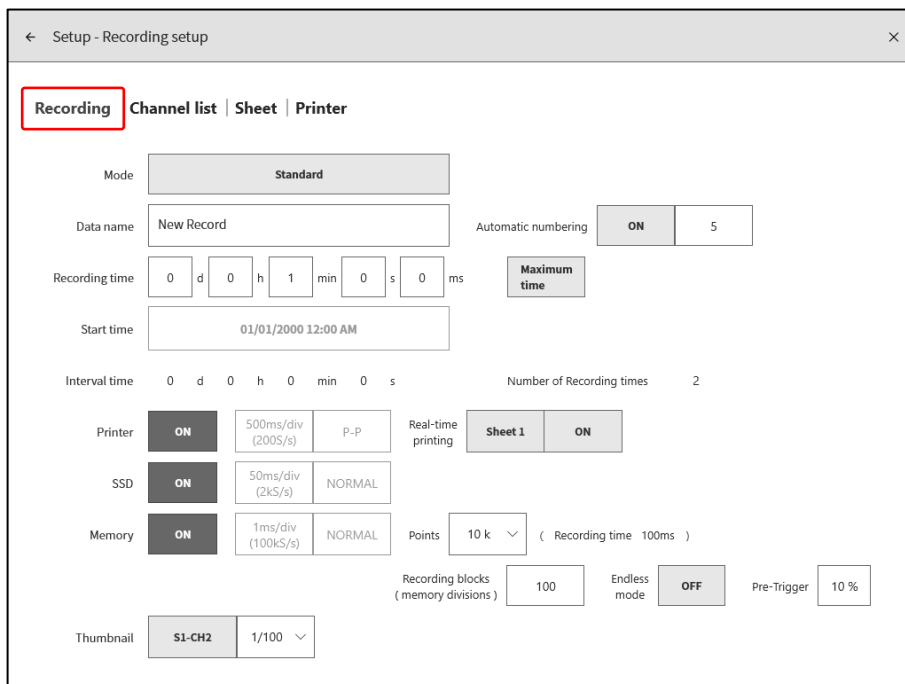

8.1.2. Channel List

Tap **Channel list** to display a list of the input modules, then tap **Common**, **Conversion**, **Sheet**, or **a module type** above the list to display the corresponding list.

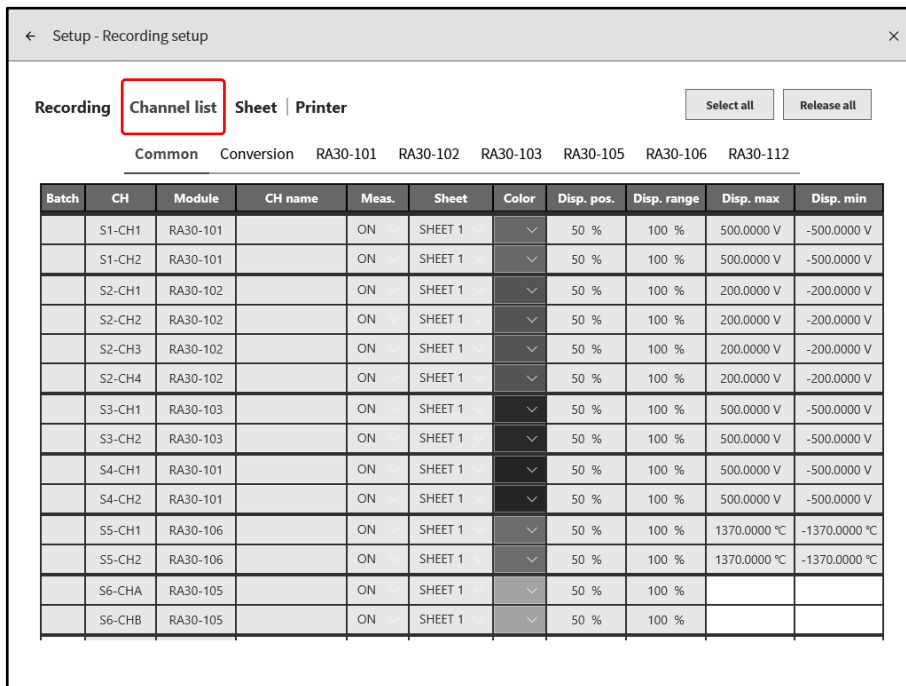

Common Setup

When **Common** is tapped, the settings common to all input modules are displayed, and you can tap a cell to change the setting value of that cell.

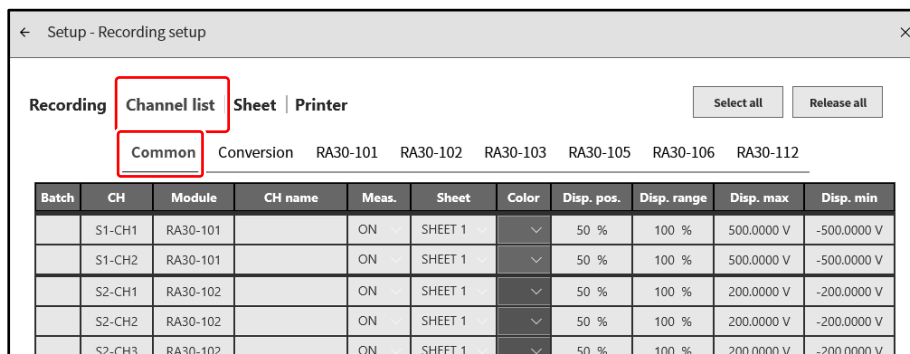

The items in the list are indicated below.

- Batch:** Enables the batch configuration of the selected channels. You can tap **Select all** on the top right to select all the channels.
- CH:** Displays the slot number and channel number, connected with a hyphen.
- Module:** Displays the model of the input module.
- CH name:** Displays the user-defined name of the input signal. Tap this field to set the channel name. Press and hold it to display the software keyboard for input.
- Meas.:** Displays whether input is enabled or disabled. Tap to switch between enabled and disabled.
- Color:** Displays the waveform color displayed on the waveform monitor. Tap to change the waveform color.
- Disp. pos.:** Displays the display position set in the channel settings. Tap to change the display position.

Disp. range: Displays the display range set in the channel settings. Tap to change the display range.

Disp. max: Displays the display maximum set in the channel settings. Tap to change the display maximum.

Disp. min: Displays the display minimum set in the channel settings. Tap to change the display minimum.

Conversion (Physical Quantity Conversion)

Batch	CH	Module	Method	Conversion 1		Conversion 2		Unit		
	S1-CH1	RA30-101	Gain	Gain	→	1.5	Offset	→	0.2	V
	S1-CH2	RA30-101	None		→			→		
	S2-CH1	RA30-102	2-pt.	20	→	1	4	→	-1	V
	S2-CH2	RA30-102	None		→			→		
	S2-CH3	RA30-102	Gain		→			→		
	S2-CH4	RA30-102	2-pt.		→			→		
	S3-CH1	RA30-103	None		→			→		

The items in the list are indicated below.

Batch: Enables the batch configuration of the selected channels.
You can tap Select all on the top right to select all the channels.

Method: Select [Gain], [2-pt.], or [None] as the conversion method.

Gain: Applies gain and offset to the input voltage and performs conversion with the primary function $y = ax + b$.

Conversion1 is gain, Conversion2 is offset

2-pt.: Converts two input voltages to two target physical quantities.

Conversion1 is the first physical conversion value, and Conversion2 is the second physical conversion value

For example, when converting the voltage of a signal input at 4-20 mA with 1 k Ω shunt resistance, the setting for resisting the input voltage value at ± 1 V is Conversion1 = 20 \rightarrow +1, Conversion2 = 4 \rightarrow 1.

None: Do not perform physical quantity conversion.

Relationship between 2-pt gain and gain compensation
The relationship between the gain specified by the 2 points a_1 (x_1, y_1) and a_2 (x_2, y_2) and gain a and offset b of $y = ax + b$ is
gain $a = (y_2 - y_1)/(x_2 - x_1)$
offset $b = y_1 - ax_1 = y_1 - x_1(y_2 - y_1)/(x_2 - x_1)$

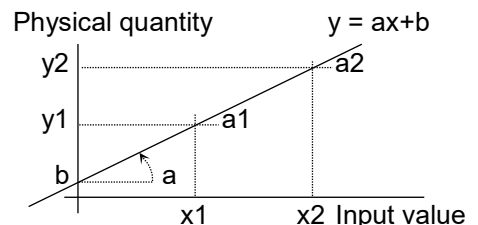

Unit: Sets the unit for the output of the physical quantity conversion. Tap to display the unit table and select the target unit. If the target unit is not in the table, tap the **【Unit list】** key and change the unit table.

Setup Unique to Module Types

Tap the **【module type】** (RA30-xxx) to display a list of the settings unique to the same type of installed module. For information on the settings for each module, see "9. Using Optional Modules". An example of the RA30-101 is indicated below.

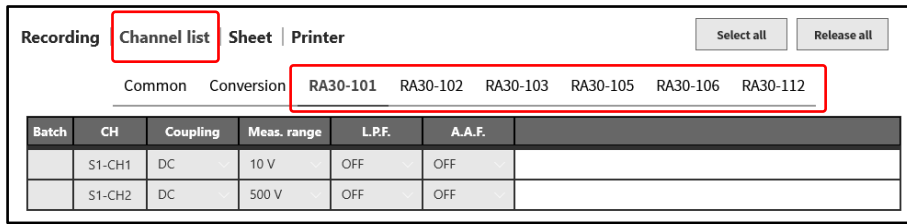

Tap **【RA30-101】** to display a list of the settings unique to the RA30-101 (two channel voltage module). The items in the list are indicated below.

- CH: Displays the slot number and channel number, connected with a hyphen.
- Coupling: Displays the state of coupling (DC, AC, or GND) that is set. Tap to set coupling.
- Meas. range: Displays the measurement range of the input module. Tap to change the range.
- L.P.F.: Displays the low-pass filter setting. Tap to change the filter.
- A.A.F.: Displays the antialiasing filter setting. Tap to change the filter.

8.1.3. Sheet Setup

Tap Sheet in the recording settings to display the graph settings and a list of the monitor display and printer waveform sheet settings.

Graph

Tap **Graph** to display the settings related to the number of divisions (number of graphs) of the Y-T waveform.

You can tap a cell to change the setting value of that cell.

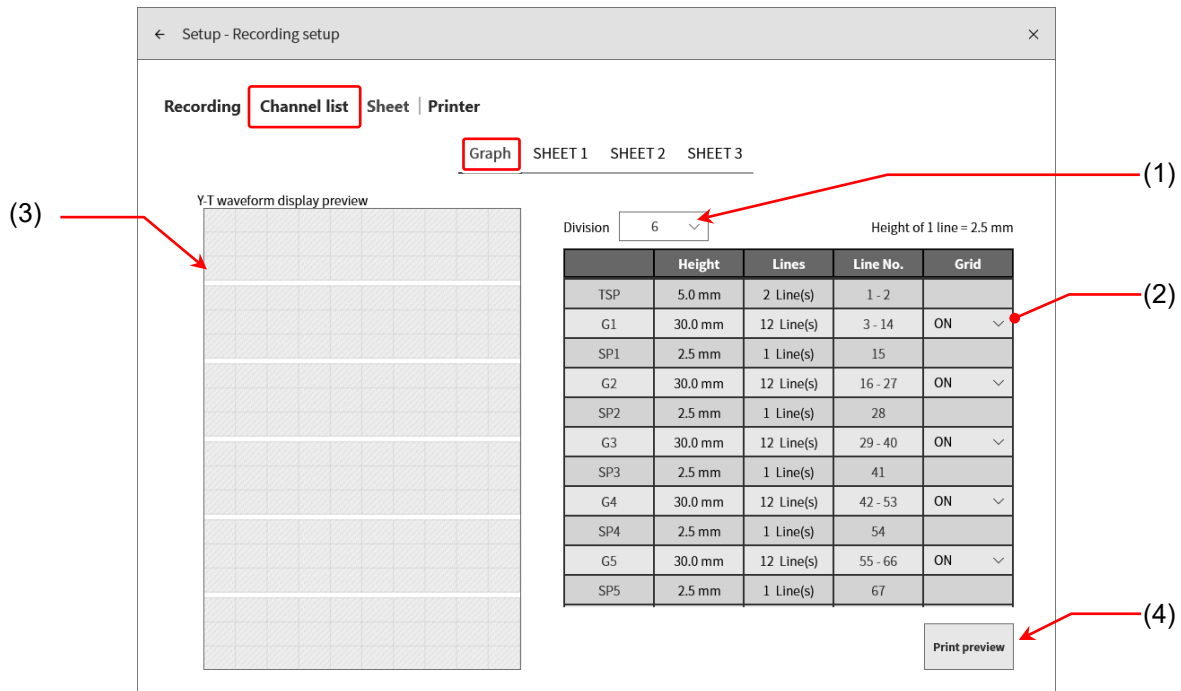

(1) Y-T waveform display preview:

Displays a preview of the grid on the Y-T waveform screen when you change settings such as the number of divisions or the height.

(2) Number of divisions:

Selects the number of divisions (number of graphs) of the Y-T waveform. (maximum 18)

(3) Division settings:

Sets the graph height and space height, and enables/disables the grid.

The settings are displayed for the selected number of graphs.

TSP (Top SPace) Indicates a space on the top.

BSP (Bottom SPace) Indicates a space on the bottom.

G# (Graph) Indicates each graph. (# is the graph number)

SP# (SPace) Indicates the space between each graph. (# is the space number)

Height/number of lines:

Sets the graph (G#) or space (SP#) to print on the recording paper by the height or number of lines.

When setting by height, it is set in increments of 2.5 mm (the height of one line).

Line number: Displays the line number of the print position.

Grid: Enables/disables the displaying/printing of the grid.

Enable "Text to Print" in "8.1.4 Printer" or the grid setting in "8.2.6 Display Setup".

8.Setup Details – 8.1.Recording Setup

- (4) Print preview: Opens a screen displaying a print preview of the Y-T waveform.
This enables you to check the print position of the grid and "Printing Setup" and "Text to Print" in "8.1.4 Printer".

Pinch out to enlarge the display. Swipe to move.

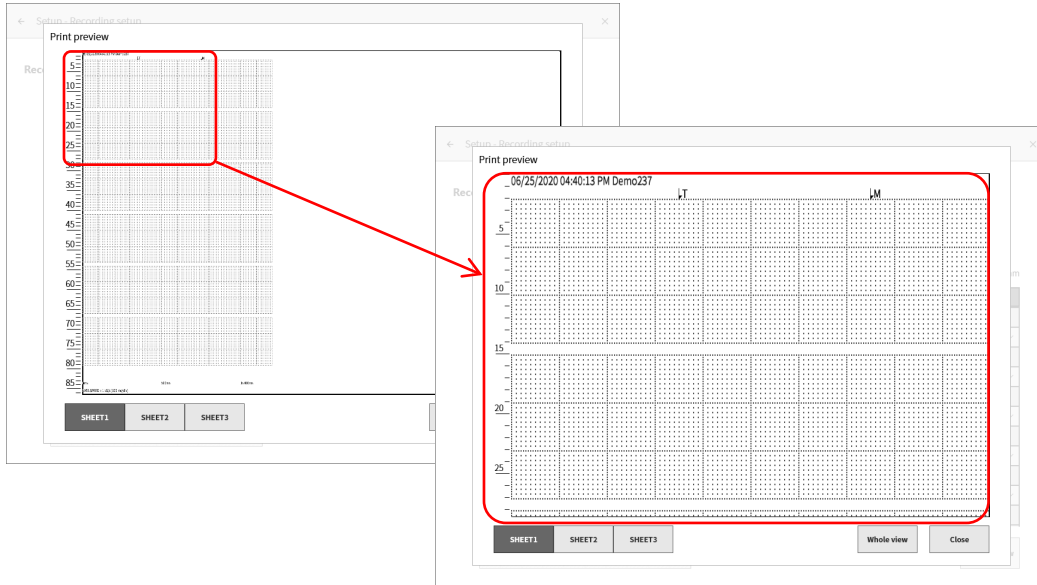

Sheet switching keys: The **[SHEET1]**, **[SHEET2]**, **[SHEET3]** keys on the bottom left enable you to check the display of each sheet. You can check the signal names and scale values.

Whole view: When the display is enlarged, tap the **Whole view** key to resize the display to match the height.

Close: Closes the screen.

SHEET1/ SHEET2/ SHEET3

Tap **[Sheet]** in the recording settings to display a list of the monitor display and printer waveform sheet settings.

Graph	Channel	Number of channels used
G1	S1-CH1 / S1-CH2 / S6-CHA1 / S6-CHA8	24 / 48 ch
G2	S2-CH1 / S2-CH2 / S6-CHA2 / S6-CHA7	
G3	S2-CH3 / S2-CH4 / S6-CHA3	
G4	S3-CH1 / S3-CH2 / S6-CHA4	
G5	S6-CHA5	
G6	S6-CHA6 / S6-CHB	
G7		
G8		
G9		
G10		
G11		
G12		
G13		
G14		

Tap the sheet to set or a graph cell to display the channel assignment screen. The target sheet number and graph number are displayed on the center top of the screen.

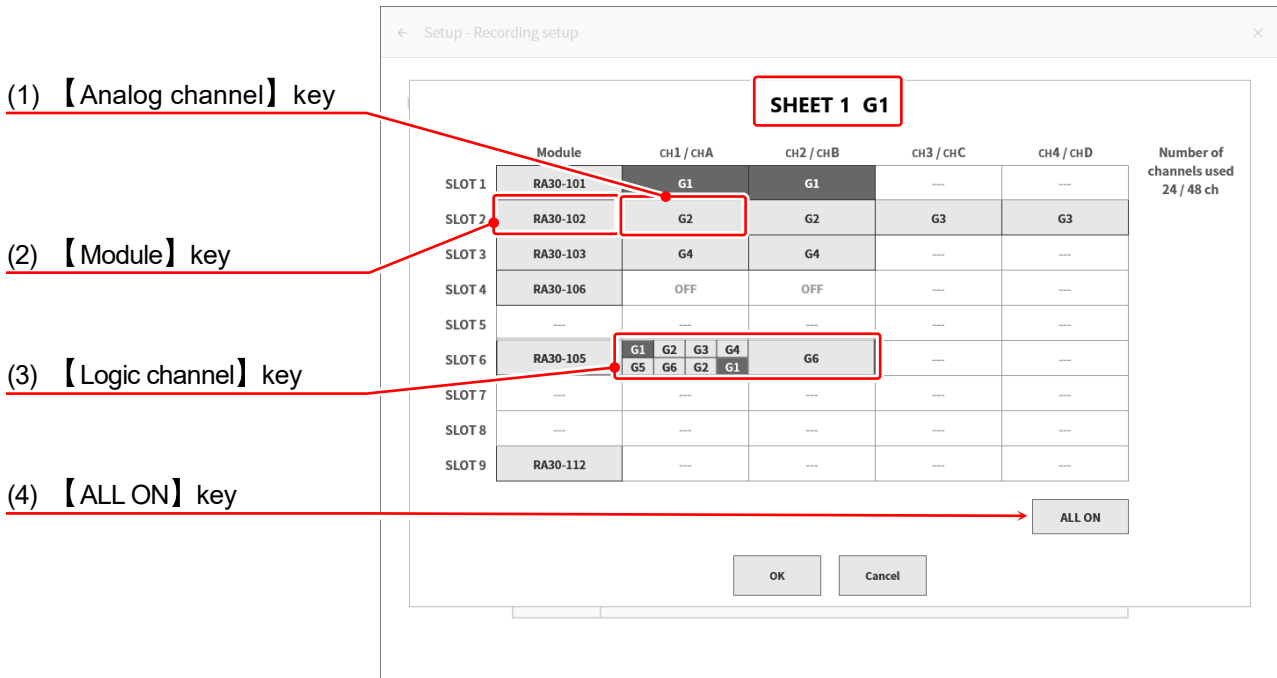

- (1) **【Analog channel】** key: Tap to assign the selected channel to the graph of the sheet.
- (2) **【Module】** key: Tap to assign all channels of the module to the graph of the sheet.
- (3) **【Logic channel】** key: When the signal unit is set to "1 CH" in "9.4.2 Setting the Input Channel" ("16 Channel Logic Module (RA30-105)"), assignment is performed on a single channel basis. Tap the channel key to display a dialog and assign the selected channel to the graph of the sheet.
When the signal unit is set to "8 CH", assignment is performed on an eight channel basis (CHA/CHB).



- (4) **【ALL ON】** key: Tap to assign all channels of all modules to the graph of the sheet.

Up to 48 channels can be enabled for a single sheet, and the current number of channels used is displayed on the right side of the table. When the number of channels used exceeds 48, tap **【OK】** or **【Cancel】** and assign the channels on another sheet.

8.1.4. Printer

Tap **Printer** in the recording settings to configure the various print functions for printer output.

Printing Setup

Tap **Printing** to configure the various information printed at the same time as the waveform.



Header: This product prints the header Text/CH name before printing the waveform. Select **Text**, **CH name**, **Text/CH name**, or **OFF** as the information to print before the waveform.

Annotation: Enables or disables the printing of annotation text to print at the same time as the waveform. Select **Text** or **OFF**.

Footer: Select **Text**, **Scale value**, **Text/Scale value**, or **OFF** as the footer text to print after waveform recording ends.

Grid: Selects the grid pattern to print with the waveform. Select **10 mm STD**, **10 mm**, **5 mm STD**, **5 mm**, or **OFF**.

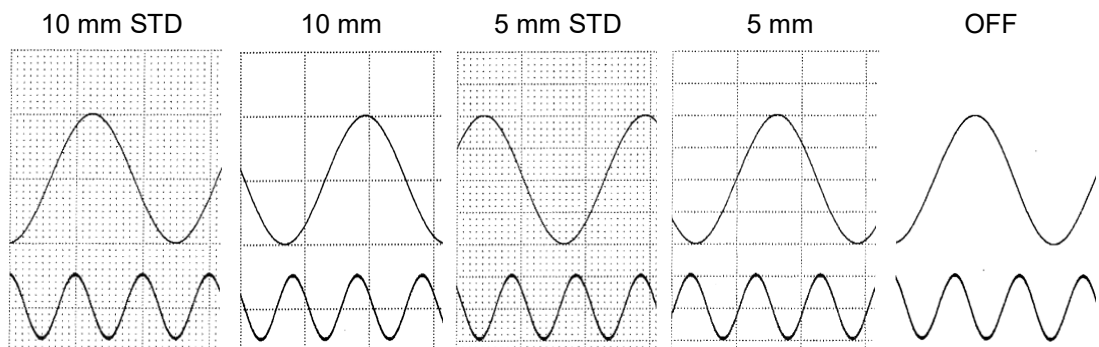

Date/Data name: Select **【 Date 】**, **【 Date name 】**, **【 Date / Date name 】**, or **【 OFF 】**.

Trigger/mark: Select **【 ON 】** or **【 OFF 】**.

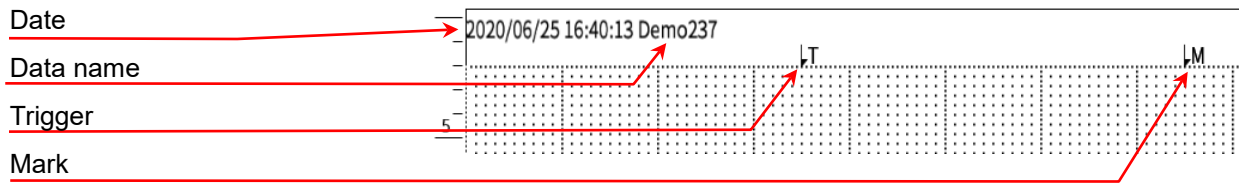

Time axis: Select **【 ON 】** or **【 OFF 】**. The X axis notation set in "8.2.6 Display Setup" is used as the notation. When the X axis notation is set to "date", two lines are printed.

NOTE

For the 86th line, the 2nd line is not printed.

Recording speed: Select **【 Sampling speed 】**, **【 Chart speed 】**, or **【 OFF 】** as the recording speed to print below the waveform.

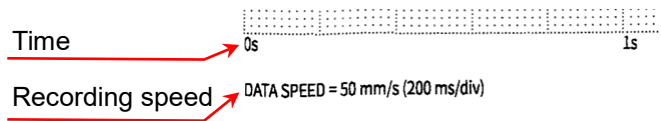

Printing example

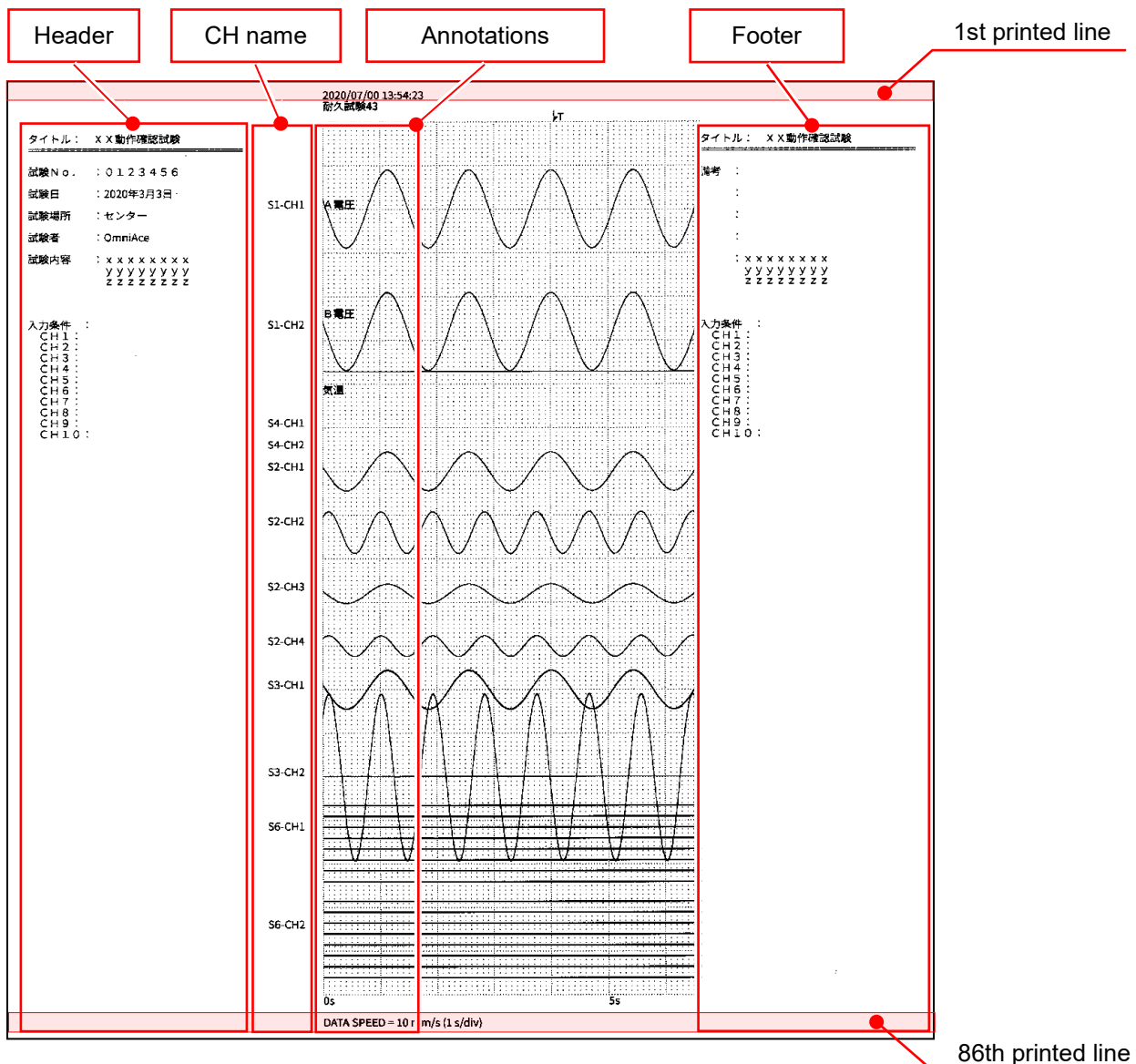

Text to Print

Tap **【 Header 】**, **【 Annotation 】**, or **【 Footer 】** to display the corresponding settings screen for the text to print. The setting method is the same for each.

For details, see "6.2.3. [Setting and Printing Annotations](#)".

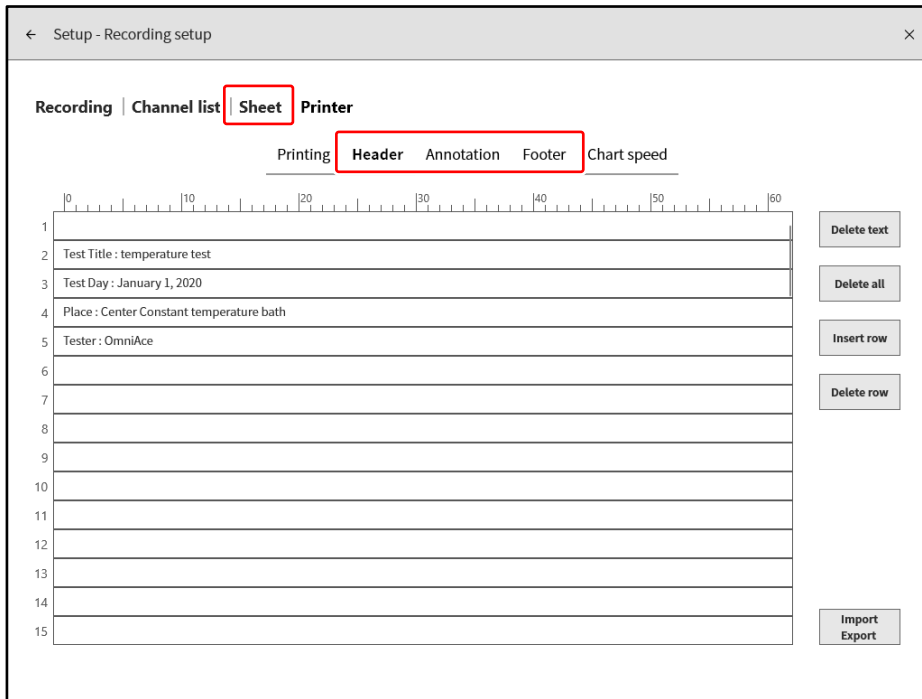

Other setup

Chart speed key: Set the user defined chart speed displayed on the control bar when **【 PRINTER 】** is selected as the recording device and **【 PEN REC 】** is selected in the menu on the right edge of the control bar.

Six chart speeds can be registered. The key on the left end is **【 Chart speed key 1 】**.

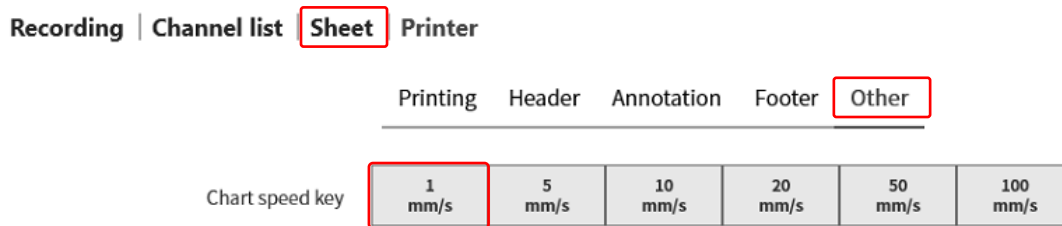

Tap a **【 Chart speed key 】** to display the setting dialog.

【 EXT. 】 refers to "10.2.2. [External Sampling](#)".

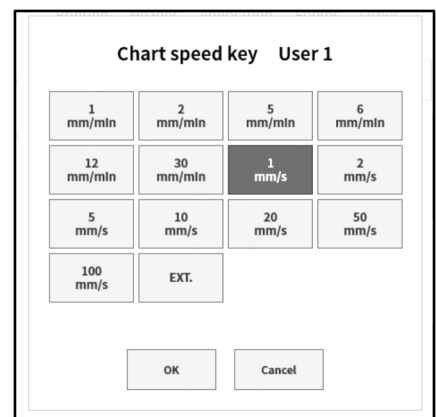

8.2. Main Unit Setup

Configure **[Record management]**, **[Image management]**, **[Environment]**, and **[Display]**. Tap a settings category to display the detailed settings screen for that category.

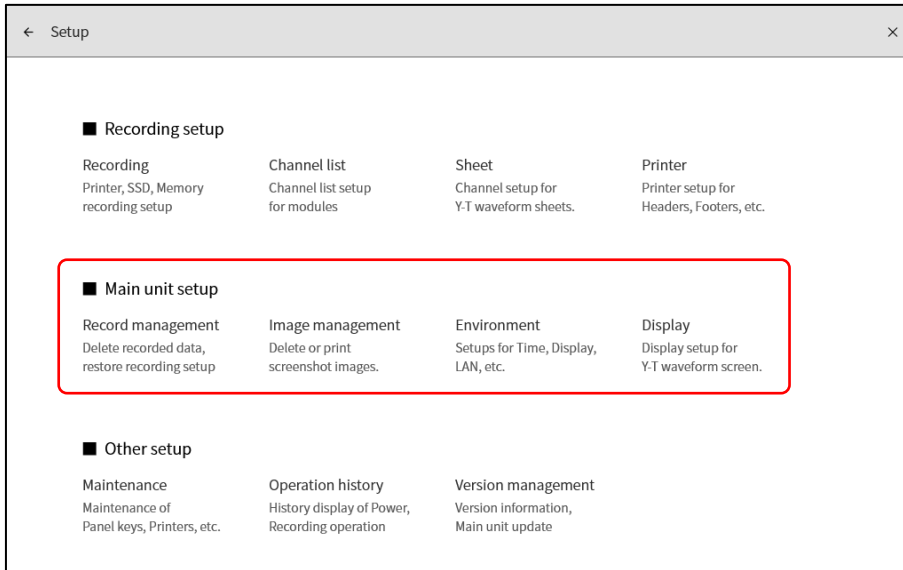

8.2.1. Record management

The method for managing data recorded with this product is explained below.

Tap **[Record management]** in the main unit settings in **[SETUP]** on the **side menu** to display the **[Record management]** screen.

A list of the recorded data on the internal SSD of the product is displayed on the left side of the **[Record management]** screen.

Tap the Data name or Date/Time in the recording data to display **[Recording info]** for that recorded data on the right.

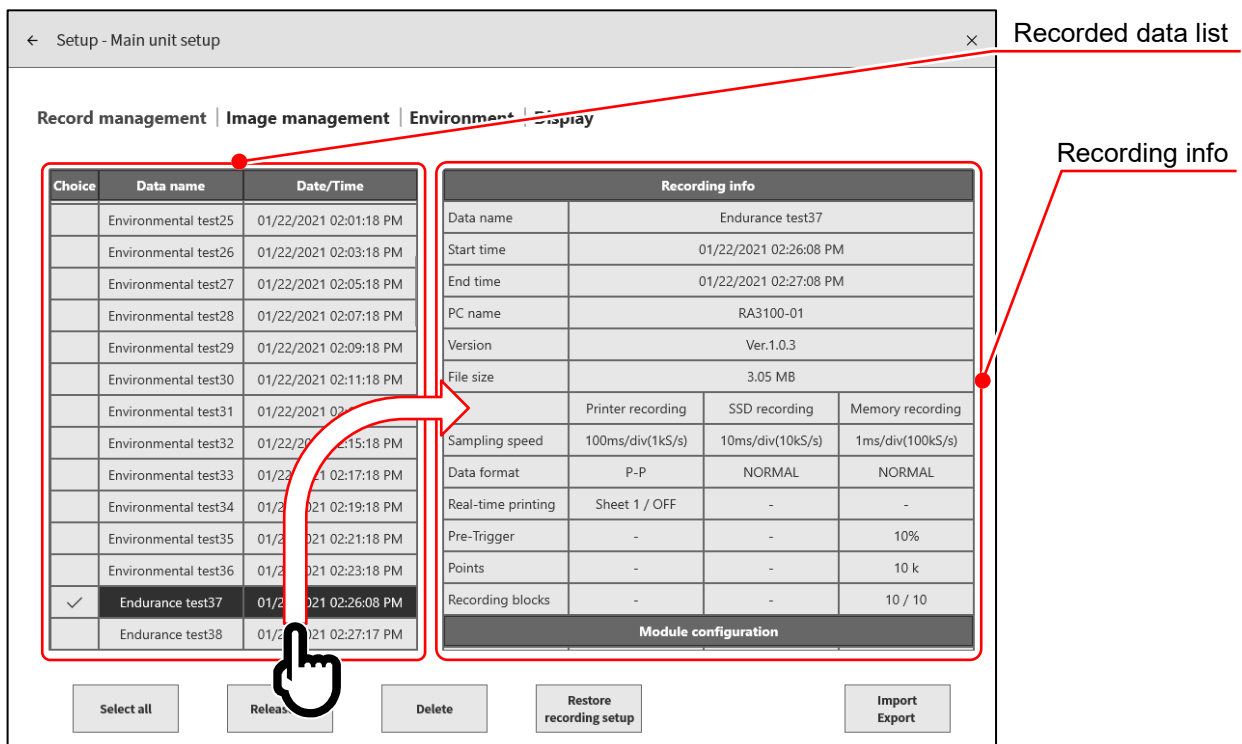

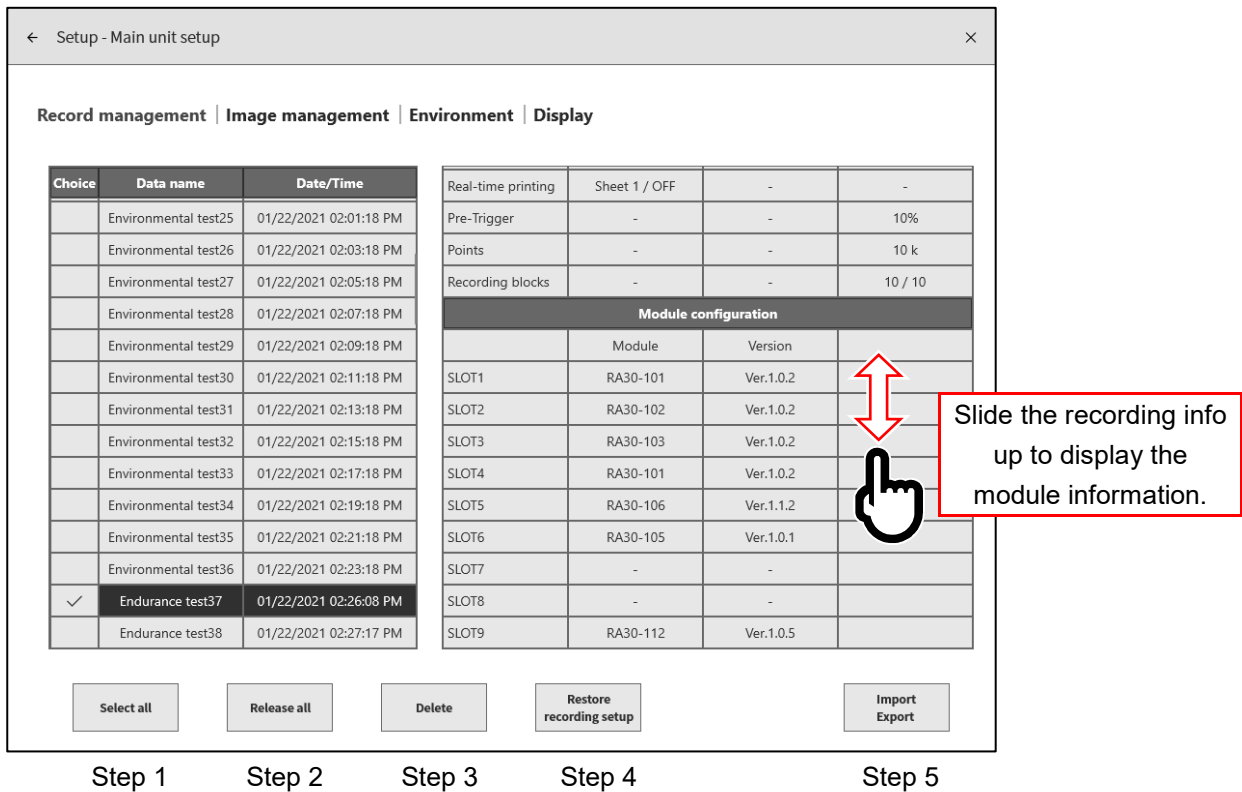

Choice	Data name	Date/Time
	Environmental test25	01/22/2021 02:01:18 PM
	Environmental test26	01/22/2021 02:03:18 PM
	Environmental test27	01/22/2021 02:05:18 PM
	Environmental test28	01/22/2021 02:07:18 PM
	Environmental test29	01/22/2021 02:09:18 PM
	Environmental test30	01/22/2021 02:11:18 PM
	Environmental test31	01/22/2021 02:13:18 PM
	Environmental test32	01/22/2021 02:15:18 PM
	Environmental test33	01/22/2021 02:17:18 PM
	Environmental test34	01/22/2021 02:19:18 PM
	Environmental test35	01/22/2021 02:21:18 PM
	Environmental test36	01/22/2021 02:23:18 PM
✓	Endurance test37	01/22/2021 02:26:08 PM
	Endurance test38	01/22/2021 02:27:17 PM

Real-time printing	Sheet 1 / OFF	-	-
Pre-Trigger	-	-	10%
Points	-	-	10 k
Recording blocks	-	-	10 / 10
Module configuration			
	Module	Version	
SLOT1	RA30-101	Ver.1.0.2	
SLOT2	RA30-102	Ver.1.0.2	
SLOT3	RA30-103	Ver.1.0.2	
SLOT4	RA30-101	Ver.1.0.2	
SLOT5	RA30-106	Ver.1.1.2	
SLOT6	RA30-105	Ver.1.0.1	
SLOT7	-	-	
SLOT8	-	-	
SLOT9	RA30-112	Ver.1.0.5	

Record management Operations

Tap a selection field on the left of the list to display "✓" to select that data as the target for deletion or setting restoration. Tap the selection field again to deselect the data.

- Step 1. Select all: Selects all the recorded data.
- Step 2. Release all: Deselects all the data.
- Step 3. Delete: Deletes the selected recorded data.
- Step 4. Restore recording setup: Restores the settings saved together with the recorded data to the main unit.
- Step 5. Import/Export: Exports recorded data to external media (such as an SD memory card or USB stick) or imports (reads) the data backed up to external media.

Restoring recording setup

The recording settings of this product are saved together with the recorded data.

Select the data for the recording conditions to restore/set again on the [Record management] screen, and tap the **【Restore recording setup】** key to set the recording conditions to the main unit.

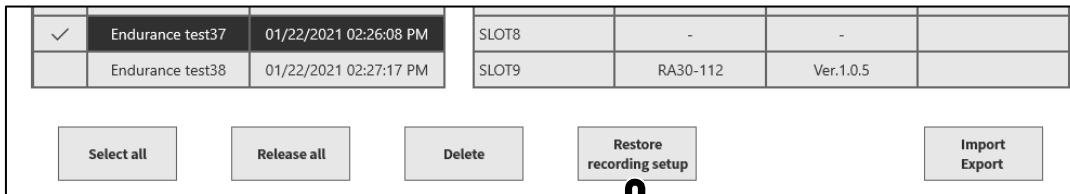

NOTE

- Saving the data with the recording conditions in the recording name (such as pressing the **【START】** key then the **【STOP】** key in a short time) enables the recordings to be easily restored at a later date. The data saved for recording conditions can be exported to external media by itself to easily restore recording condition settings.

8.2.2. Export - Backing Up Recorded Data

Connect the external storage media (such as SD memory card or USB stick) to the main unit and confirm that the SD/USB indicator on the [side menu](#) activates.

Tap the **【Import/Export】** key on the bottom right of the [Record management] screen to display the external media selection dialog and select the target external media.

Tap **【OK】** to switch to the [Import/Export] screen.

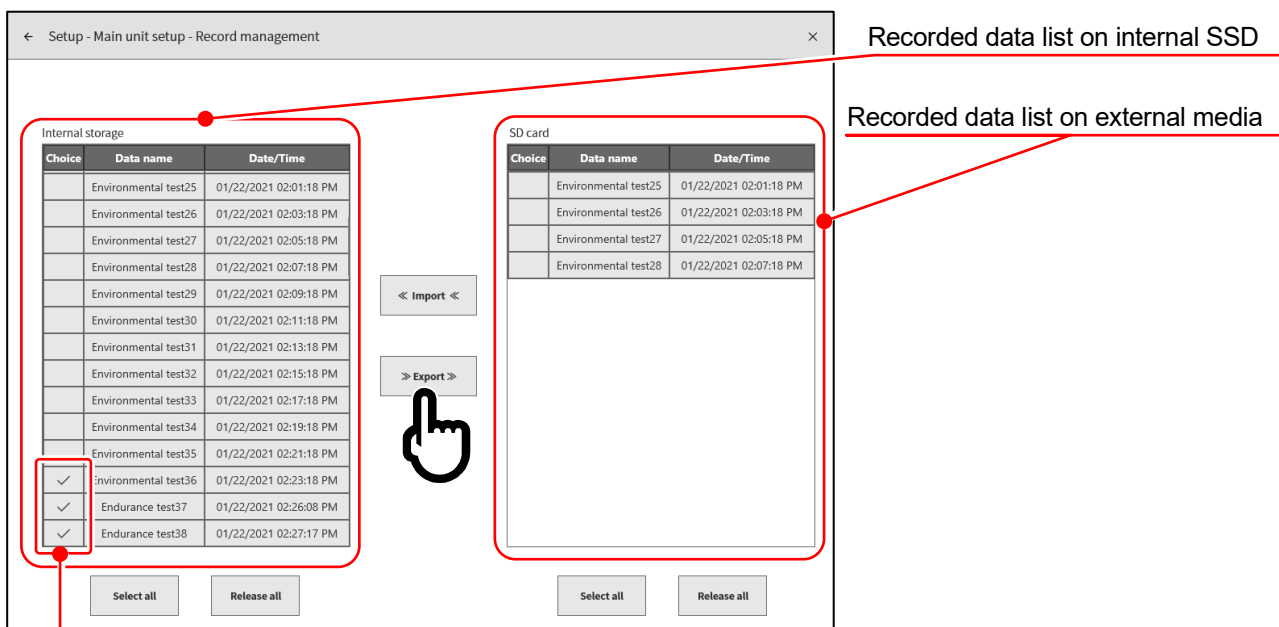

Place a check mark (✓) on the data to back up

Place a check mark (✓) in the selection field of the data to back up and tap the **【Export】** key in the center to export the recorded data.

8.2.3. Import - Reading Backup Data

Open the [Import/Export] screen in the same way as when exporting data, and import backup data backed up to external media to the main unit.

When importing, place a check mark (✓) in the recorded data list for external media on the right, and tap the **[Import]** key in the center.

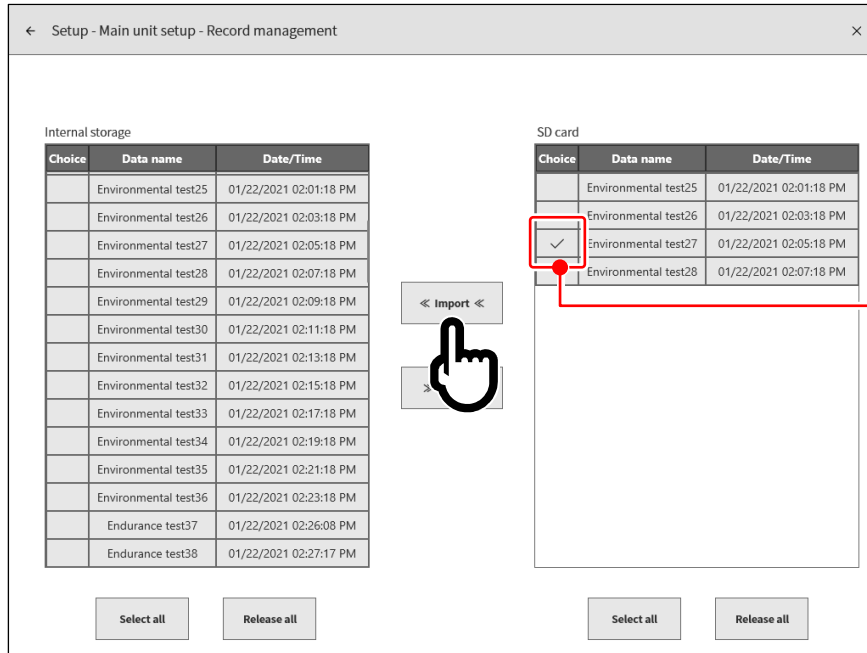

When the same data as the backup exists in the internal storage, a cautionary dialog box is displayed, and you can select the appropriate operation using the **[Overwrite]**, **[Skip]**, or **[Cancel]** key.

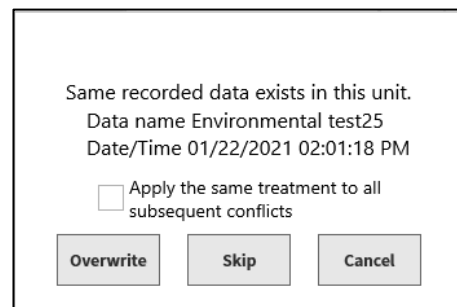

8.2.4. Image Management

Tap **[Image management]** in the main unit settings to display the [Image management] screen. Press and hold the **[PRINT]** key on the [Image management] screen to manage the screenshot images of the monitor.

A list of the image data on the internal SSD of the product is displayed on the left side of the screen. Tap the date field in the list to display a preview of that image on the right.

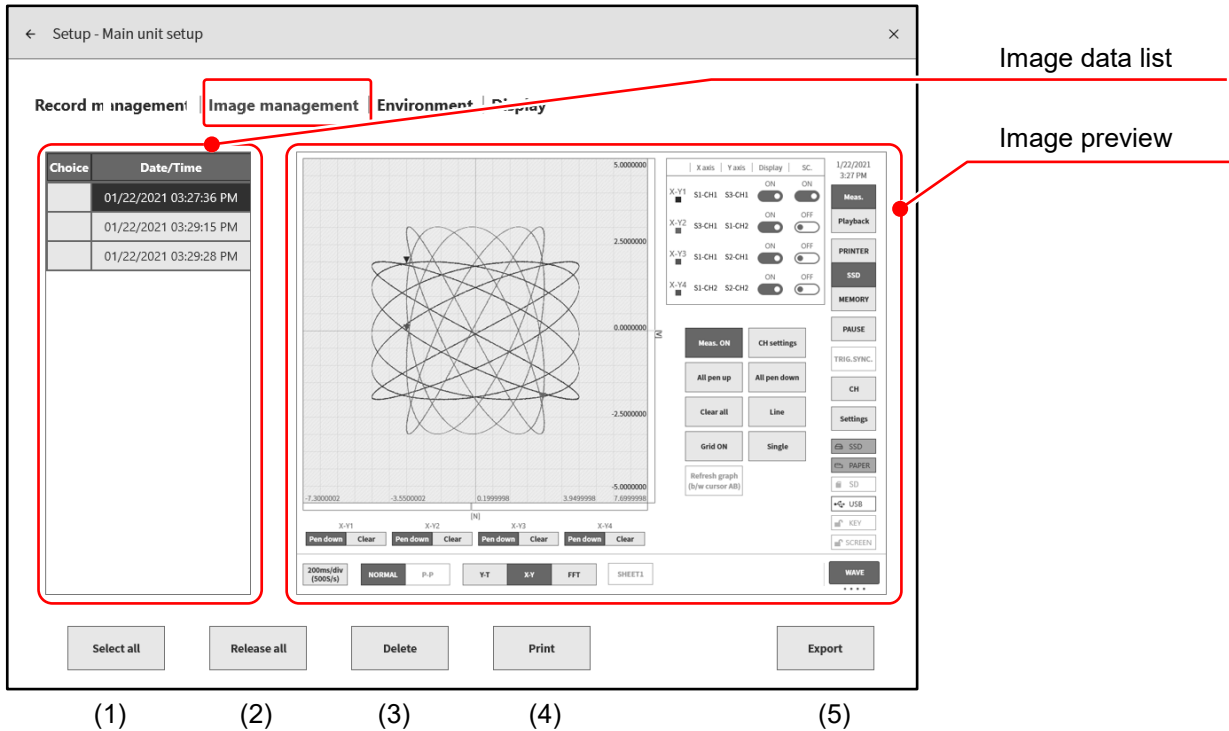

Image Management Operations

Tap a selection field on the left of the list to display "✓" to select that data as the target for operation.

Tap the selection field again to deselect the data.

- (1) **Select all:** Selects all the image data.
- (2) **Release all:** Deselects all the data.
- (3) **Delete:** Deletes the selected image data.
- (4) **Print:** Prints the image data displayed in the preview from the printer.
- (5) **Export:** Exports image data to external media (such as an SD memory card or USB stick).

Exporting Images

Tap the **[Export]** key in step 5 to display the external media selection dialog box and select the target external media. Tap **[OK]** to switch to the [Export] screen. Place a check mark (✓) in the selection field of the data to export and tap the **[Export]** key in the center to export the recorded data.

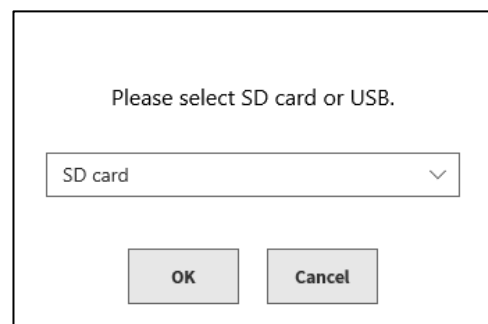

Place a check mark (✓) in the selection field of the data to export

Image data list on internal SSD

Image data list on external media

The screenshot shows a software interface for image management. It features two main sections: 'Internal storage' on the left and 'SD card' on the right. Each section contains a table with columns for 'Choice' and 'Date/Time'. In the 'Internal storage' table, the first row has a checkmark in the 'Choice' column. Below these tables is a central button labeled '>> Export >>' with a hand cursor icon. At the bottom of each section are 'Select all' and 'Release all' buttons. Red lines and dots point from the text labels to the respective tables.

Choice	Date/Time
<input checked="" type="checkbox"/>	01/22/2021 03:27:36 PM
<input type="checkbox"/>	01/22/2021 03:29:15 PM
<input type="checkbox"/>	01/22/2021 03:29:28 PM

Choice	Date/Time
<input type="checkbox"/>	01/22/2021 03:27:36 PM

8.2.5. Environment Setup

Tap **[Environment]** in the main unit settings to display the [Environment] screen.

The environment settings and communication settings of the product can be configured on the [Environment] screen.

Environment Setup

Tap the **[Environment]** key in the center of the [Environment] screen to display the environment setup screen.

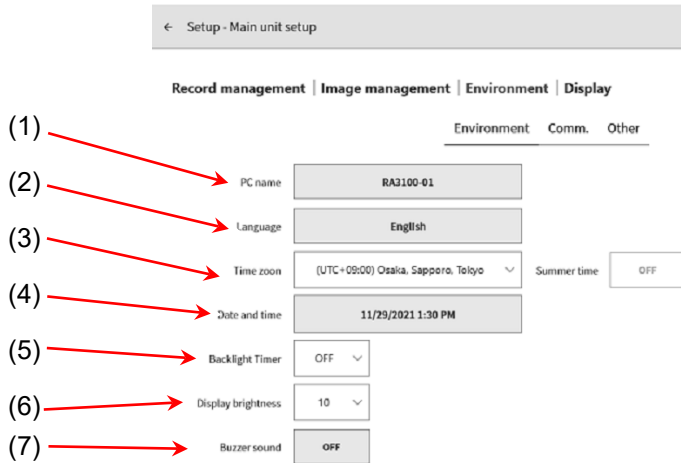

The functions of each item are indicated below.

- (1) PC name: Sets the name of this product. Tap the name field to display the [PC name] dialog box for changing the name. Double-tap the name to display the software keyboard.

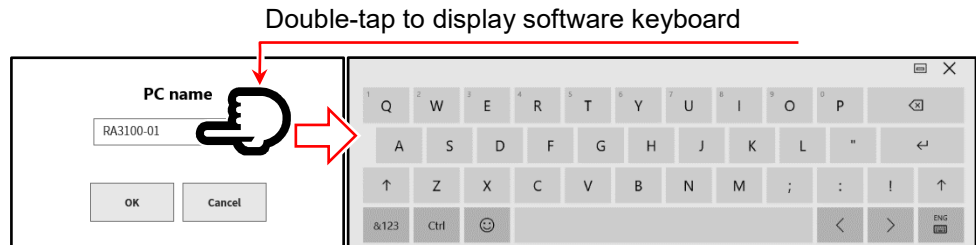

- (2) Language: The display language of this product.
- (3) Time zone: Sets the time zone of the clock in this product.

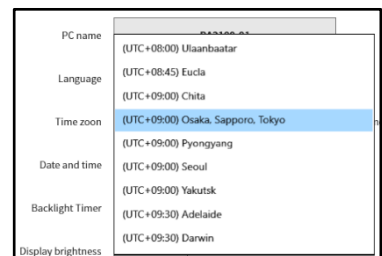

- (4) Date and time: Sets the time of this product. Tap the **[Date and time]** key to display the [Date and time] dialog box. Tap and set the year, month, day, hour, and minute.

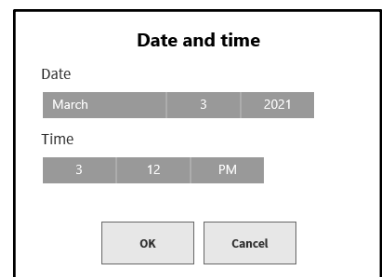

- (5) Backlight Timer: This function automatically turns off the monitor when the product has not been operated for the specified period of time. Select [OFF], [1 minute], [5 minutes], [10 minutes], [30 minutes], or [60 minutes]. Select [OFF] to always display the monitor.



- (6) Display brightness: Changes the screen brightness. Set a value between 1 and 10.

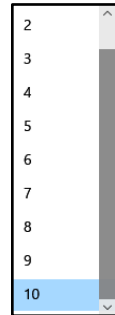

- (7) Buzzer sound: Enable this setting to emit a buzzer when the range is exceeded, or disable it to not.

Communication Setup

Tap the **【Comm.】** key in the center of the [Environment] screen to display the communication setup screen, which enables you to configure the network and RS-232C.

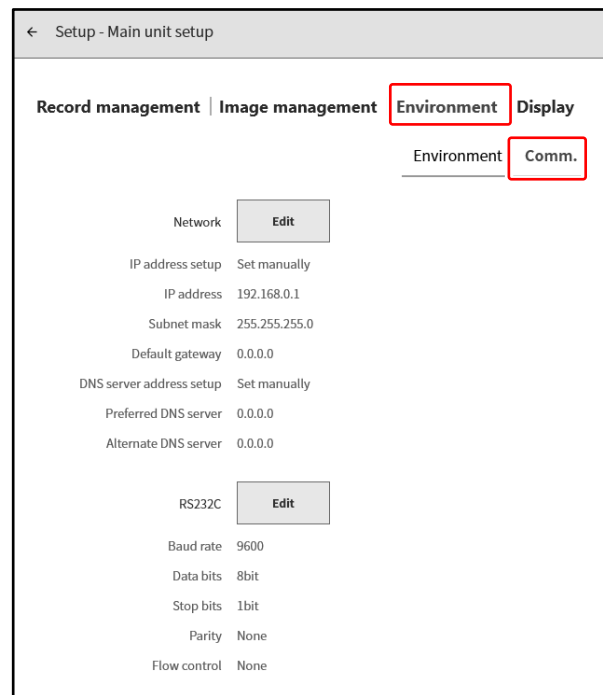

Network Setup

CAUTION

□ Caution Regarding Network Setup

When connecting this product to an on-premise network, contact the network administrator regarding the network settings.

Tap the network **[Edit]** key on the [Comm.] setup screen to display the network setup dialog box. Tap **[OK]** to continue without turning off the power.

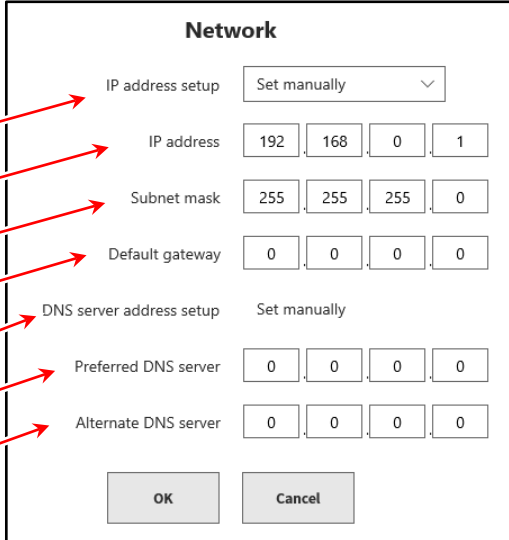

The screenshot shows a 'Network' dialog box with the following fields and callouts:

- (1) IP address setup: Set manually (dropdown)
- (2) IP address: 192, 168, 0, 1
- (3) Subnet mask: 255, 255, 255, 0
- (4) Default gateway: 0, 0, 0, 0
- (5) DNS server address setup: Set manually (dropdown)
- (6) Preferred DNS server: 0, 0, 0, 0
- (7) Alternate DNS server: 0, 0, 0, 0

Buttons: OK, Cancel

- (1) IP address setup: Select whether "obtain automatically" (using DHCP) or "set manually" for the LAN. The settings in (2) to (4) are not required for obtain automatically.
- (2) IP address: Manually sets the IP address of the LAN. Since the IP address is unique to the device, make sure to set a different address when connecting two or more of this product.
- (3) Subnet mask: The value that defines the IP address range (subnet). Normally set class C.
Class C: 255.255.255.000
Class B: 255.255.000.000
Class A: 255.000.000.000
- (4) Default gateway: Sets the IP address of the gateway device for connecting the network that the product is connected to with external networks.
- (5) DNS server address setup: Select whether to automatically retrieve or manually set the IP address of the DNS server. The settings in (6) to (7) are not required for automatic retrieval.
- (6) Preferred DNS server: Sets the IP address of the preferred DNS server on the network.
- (7) Alternate DNS server: Sets the IP address of the alternate DNS server on the network.

NOTE

- When using the LAN port to communicate with an external device, use port 3000.

RS-232C Setup

CAUTION

□ Caution Regarding RS-232C Settings

When using the RS-232C port of this product to communicate with an external device, match the RS-232C settings with those of the host device.

Tap the [RS-232C] **[Edit]** key on the [Comm.] settings screen to display the RS-232C settings dialog box.

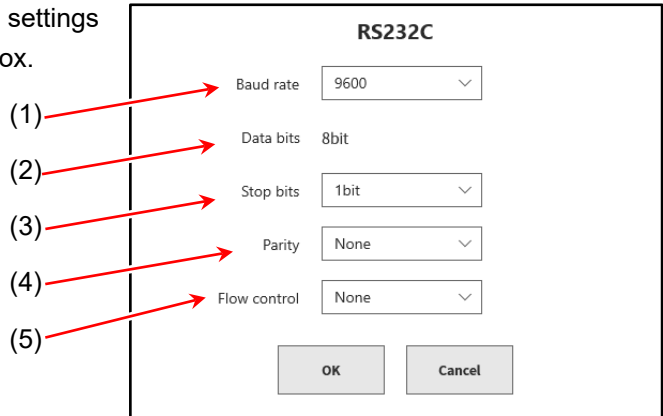

- (1) Baud rate: Sets the RS-232C data transmission speed.
Select 300, 600, 1200, 2400, 4800, 9600, 14400, 19200, 38400, 57600, 115200, 230400, or 460800 bps.
- (2) Data bits: The number of bits in one byte of data. Fixed to 8 bits.
- (3) Stop bits: The stop bits in one byte of data. Select 1 or 2 bits.
- (4) Parity: The parity bit for one byte of data.
Select none, odd, even, mark, or space.
- (5) Flow control: The flow control of communication. Hardware uses control via CTS/RTS for the communication line.
Select none, Xon/Xoff, or Hardware.

Other

Tap the **[Other setup]** key on the [Environment] screen to display the [Other setup] screen.

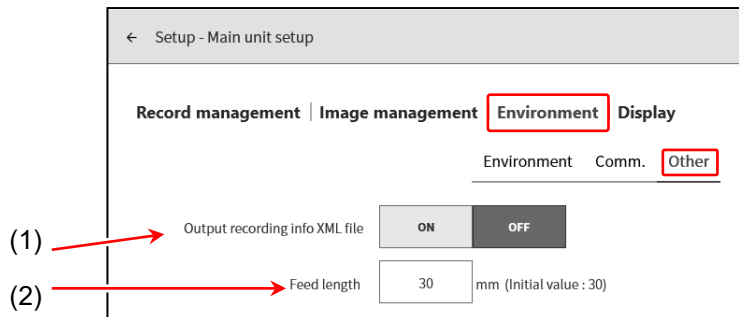

- (1) Output recording info XML file: Enable this setting to read the recording file in a custom application. When enabled, an XML format file containing the recording information is added to the recording data.
- (2) Feed length: Sets the length to feed after all printing is complete, including waveform printing and screen copy (screenshot) printing.

8.2.6. Display Setup

Tap **[Display]** in the main unit setup to display the [Display] screen.

The auxiliary monitor display functions can be set on the [Display] screen.

Grid: Switches the grid lines of the waveform monitor on or off.

Trigger line: Switches the trigger lines for trigger detection on or off.

Mark line: Switches the mark lines for mark detection on or off.

* **Mark line** is available when the optional remote control module is installed.

Search result line: Switches the search result line on or off.

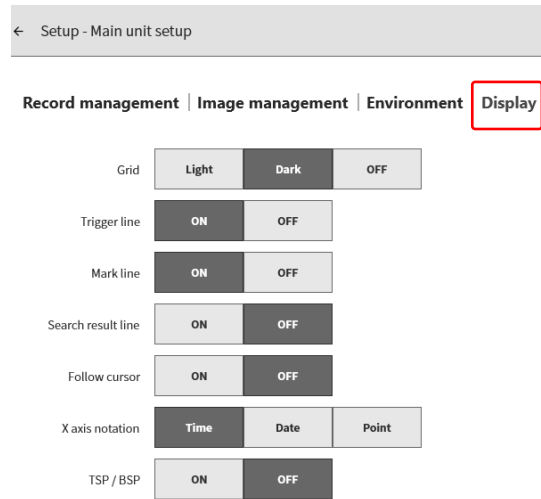

Displaying the Trigger Line, Mark Line, and Search Result Line in the waveform monitor

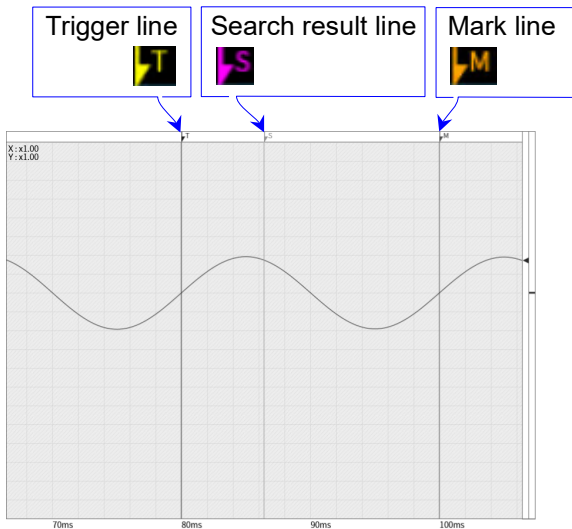

When enabled

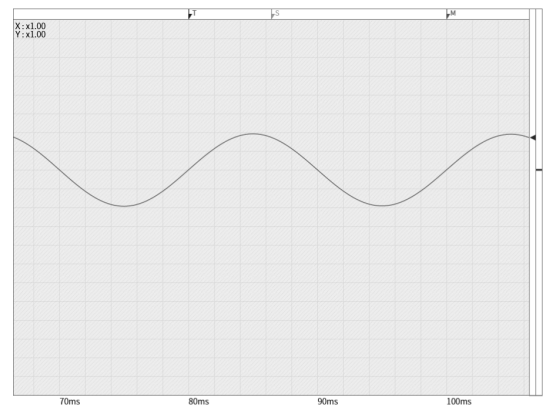

When disabled

Follow cursor:

When enabled, the waveform and cursor are displayed when the cursor moves outside the waveform monitor. When disabled, the cursor moves but the waveform does not when the waveform moves outside the waveform monitor. (The cursor line will no longer be displayed.)

X axis notation: Set the time, date, and point.

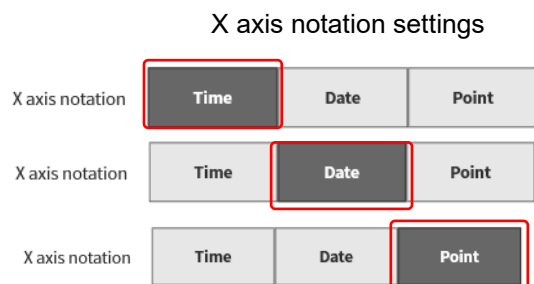

Waveform monitor X axis display

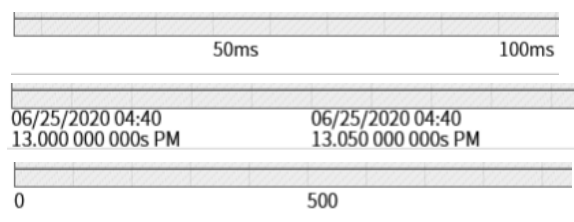

TSP/BSP: Enable/disable the TSP (Top SPace) and BSP (Bottom SPace) display settings of "Graph" in "8.1.3 Sheet Setup".

8.3. Other setup

Configure/display **【 Maintenance】**, **【 Operation history】**, and **【 Version management】**.
Tap a settings category to display the details screen for that category.

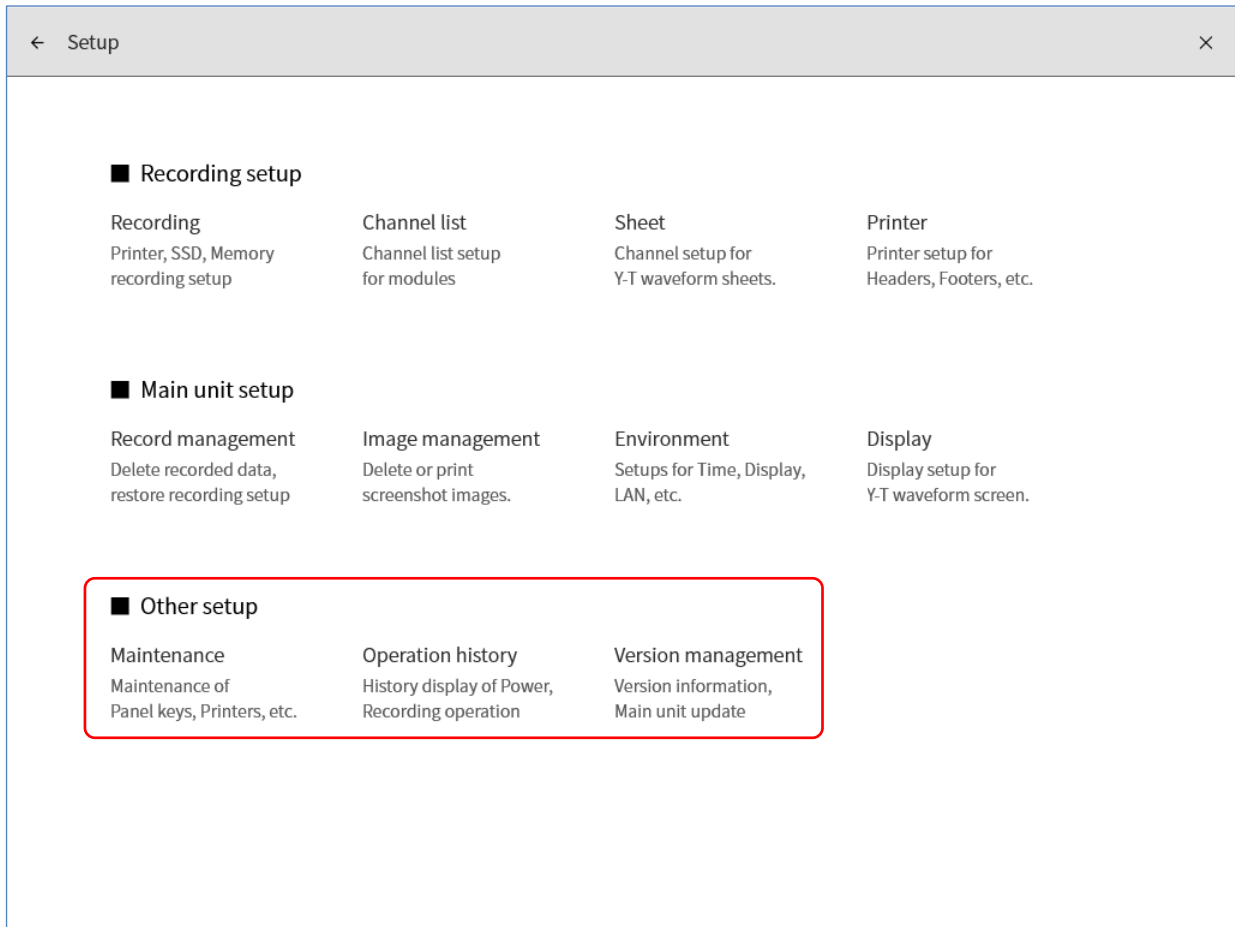

8.3.1. Maintenance

⚠ CAUTION

- ❑ If the maintenance check detects an error in this product, please contact our sales representative.
- ❑ When the life remaining is low or the health is no longer normal, it is recommended that you replace the SSD, as data will not be able to be retained in the long term.
- ❑ If [Stop] is displayed for the state of the fan, the fan has failed and needs a repair.
- ❑ The check passes if there are three or less pixel defects in the LCD at the time of delivery. When using the product for an extended period of time, deterioration in the LCD may cause pixel defects.
- ❑ The head temperature may be high after performing printer recording for an extended period of time, which can cause an error. In this case, check again after waiting a while.

Tap **【 Maintenance 】** in the other settings to display the [Maintenance] screen to perform maintenance on the product.

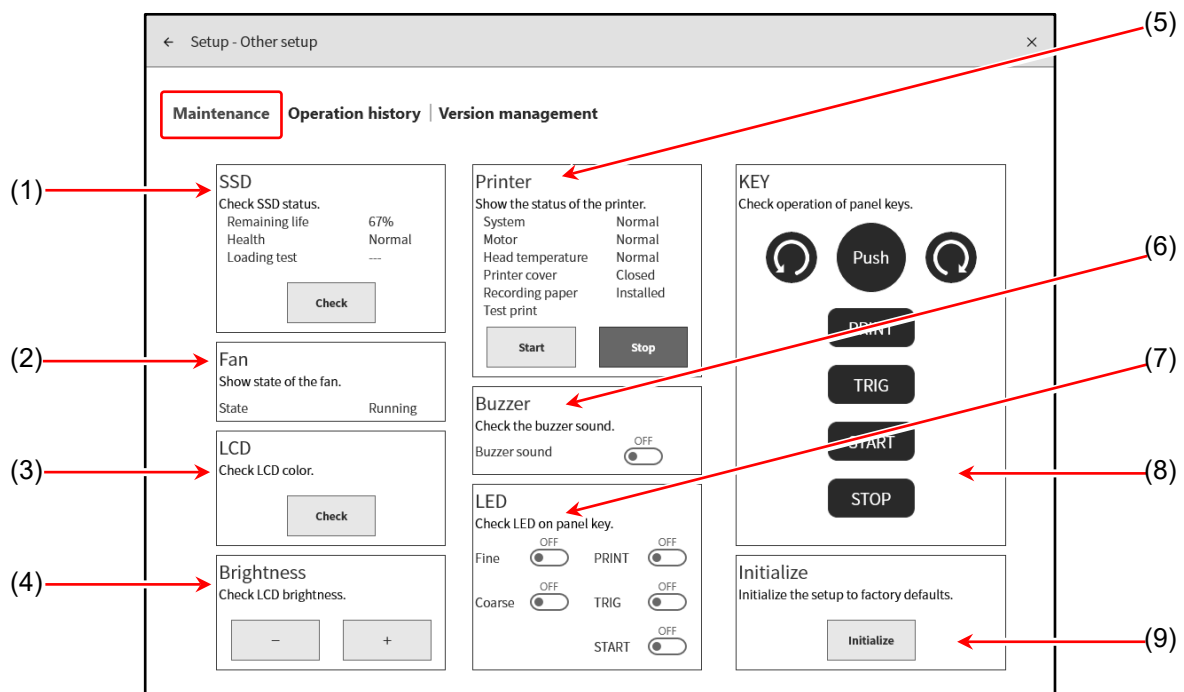

- (1) SSD: Checks the health of the internal SSD.
Tap the **【 Check 】** key to execute an SSD check and loading test, and display the results.

- (2) Fan: Displays the state of the cooling fan.

- (3) LCD: Displays the state of the LCD.

Tap the **【 Check 】** key to display the screen for checking, which switches in the order red → green → blue → white → black. Confirm that there are not any large areas with display problems (areas that are always black or white).

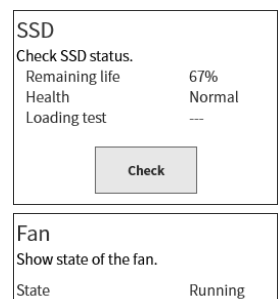

- (4) **Brightness:** Performs a brightness adjustment test on the LCD.

Tap the **[-]** key to make the screen darker.
Tap the **[+]** key to make the screen lighter.

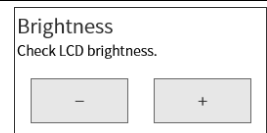

- (5) **Printer:** Displays the state of printer. You can also press the **[Start]** and **[Stop]** key for test printing to check the printing state of the printer.

Test printing prints the date and time and serial number of the main unit on recording paper, then prints a test pattern over the entire surface of the paper. The test pattern can be used to check for horizontal density variation and damage to the thermal head for printing.

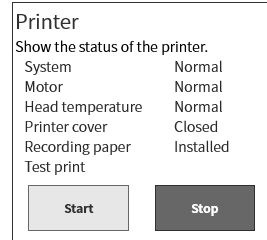

<Example test print>

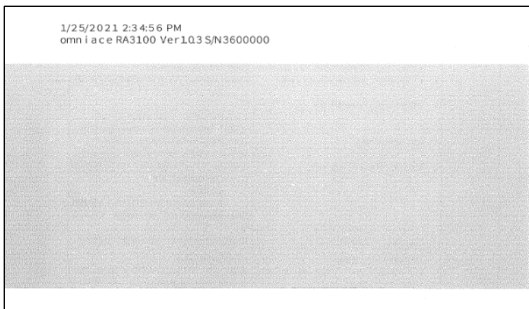

- (6) **Buzzer:** Tap the buzzer ON/OFF key to emit a beep to confirm that the buzzer works.

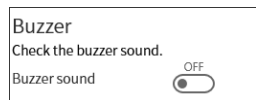

- (7) **LED:** Check the state of the main unit using the LED on the operation panel.
Use the color around the rotary knob to check the fine/coarse setting.

PRINT: Orange Fine: Orange
TRIG: Blue Coarse: Blue
START: Green

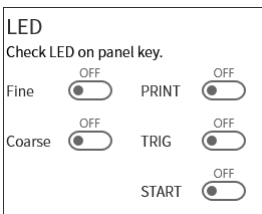

- (8) **KEY:** Use this to check the rotary knob and keys of the operation panel.
The display on the screen is highlighted when a key on the operation panel is pressed or the rotary knob is turned clockwise or counterclockwise.

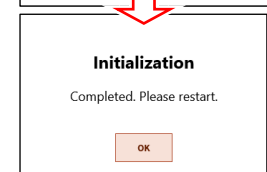
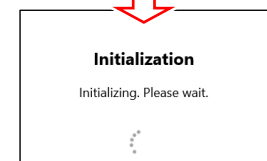
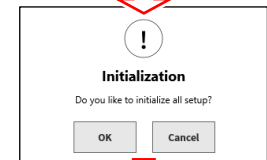
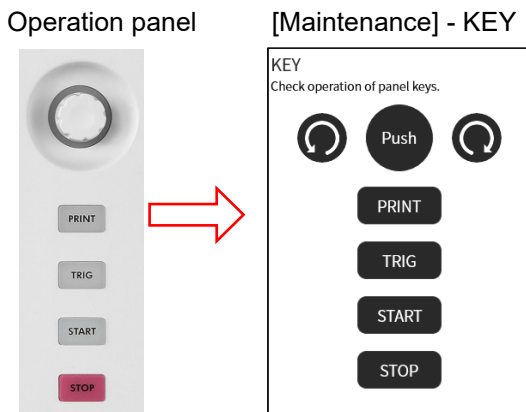

- (9) **Initialize:** Initializes this product. Tap the **[Initialize]** key, then tap **[OK]** in the confirmation dialog box displayed for executing initialization. The product automatically shuts down when initialization is complete, so press the Power switch on the front panel to turn on the product.

For information on the initialized state, see ["10.5. Setup Information after Executing Initialization"](#).

8.3.2. Operation History

Tap **Operation history** in the other settings to display the history of the last 100 operations.

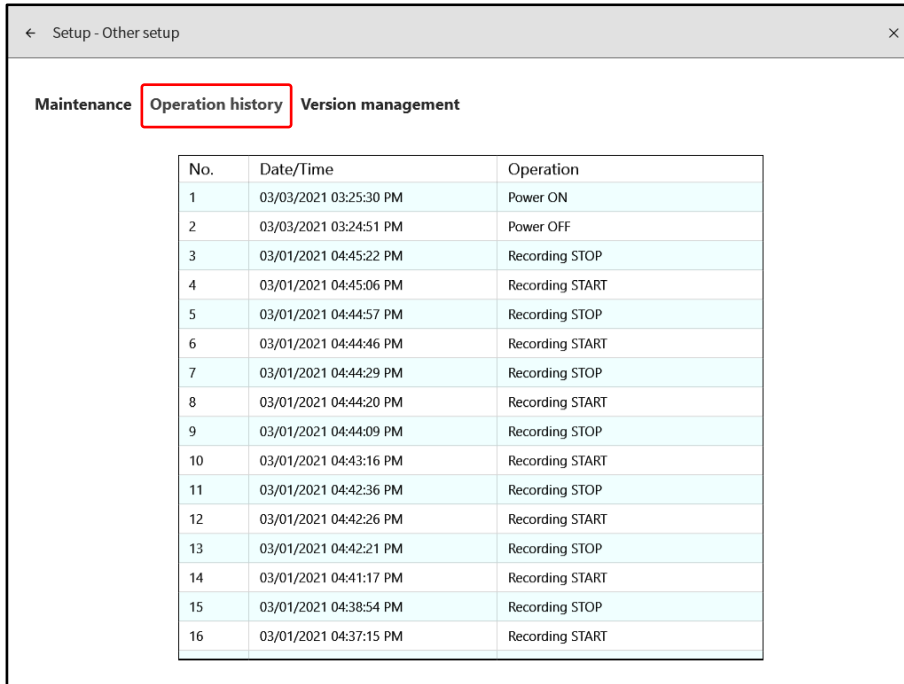

No.	Date/Time	Operation
1	03/03/2021 03:25:30 PM	Power ON
2	03/03/2021 03:24:51 PM	Power OFF
3	03/01/2021 04:45:22 PM	Recording STOP
4	03/01/2021 04:45:06 PM	Recording START
5	03/01/2021 04:44:57 PM	Recording STOP
6	03/01/2021 04:44:46 PM	Recording START
7	03/01/2021 04:44:29 PM	Recording STOP
8	03/01/2021 04:44:20 PM	Recording START
9	03/01/2021 04:44:09 PM	Recording STOP
10	03/01/2021 04:43:16 PM	Recording START
11	03/01/2021 04:42:36 PM	Recording STOP
12	03/01/2021 04:42:26 PM	Recording START
13	03/01/2021 04:42:21 PM	Recording STOP
14	03/01/2021 04:41:17 PM	Recording START
15	03/01/2021 04:38:54 PM	Recording STOP
16	03/01/2021 04:37:15 PM	Recording START

8.3.3. Version Management

Tap **Version management** in the other settings to display and update the version of this product. For information on updating, see the materials provided with the data for updating (on our website).

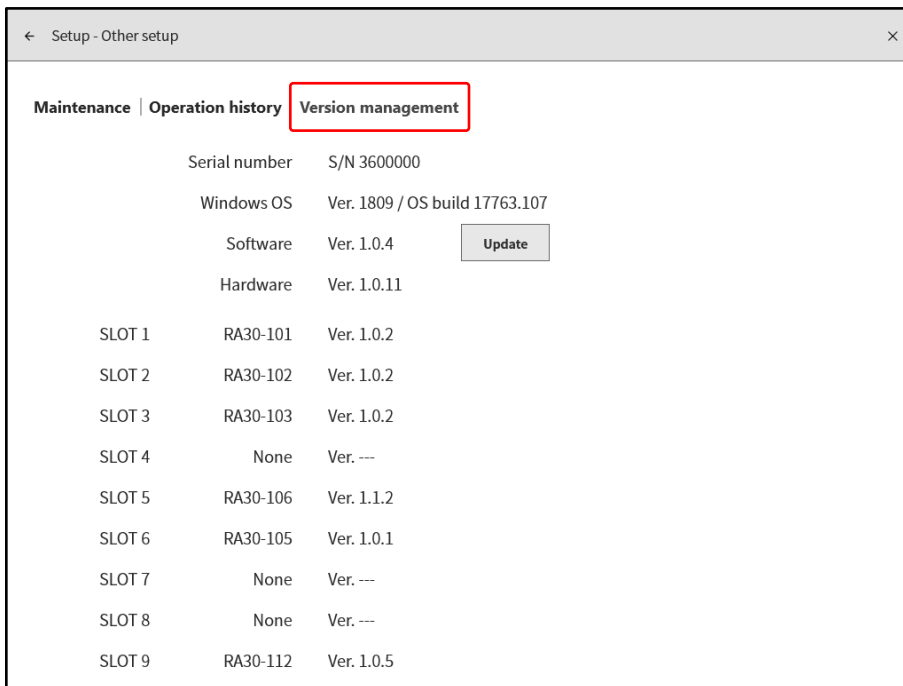

Serial number	S/N 3600000	
Windows OS	Ver. 1809 / OS build 17763.107	
Software	Ver. 1.0.4	<input type="button" value="Update"/>
Hardware	Ver. 1.0.11	
SLOT 1	RA30-101	Ver. 1.0.2
SLOT 2	RA30-102	Ver. 1.0.2
SLOT 3	RA30-103	Ver. 1.0.2
SLOT 4	None	Ver. ---
SLOT 5	RA30-106	Ver. 1.1.2
SLOT 6	RA30-105	Ver. 1.0.1
SLOT 7	None	Ver. ---
SLOT 8	None	Ver. ---
SLOT 9	RA30-112	Ver. 1.0.5

9. Using Optional Modules

This chapter provides an overview of how to use optional modules.

9.1. Two Channel Voltage Module (RA30-101)

9.1.1. Overview

This two channel voltage input module samples a DC to 100 kHz signal at 16-bit 1 MS/s within the measurement range of ± 100 mV to ± 500 V and can perform A/D conversion. It includes an antialiasing filter and analog filter. It is insulated between each channel and between input and output.

9.1.2. Setting the Input Channel

<This section describes the setting switches and setting values of the RA3100 main unit. >

- (1) Slot number, input module type
- (2) Change slot: You can change the display slot by swiping this sub menu left or right or tapping the left [**<**] and right [**>**] key.

- (3) Select channel:
Select the channel in the slot.

- (4) Meas. ON/OFF
ON: Measure and record the input signal.

- (5) Color: Change the display color of the waveform monitor.

- (6) Coupling: Switch the input signal coupling in the order DC → GND → AC. Tap the key and turn the rotary knob to select.

- (7) Meas. range:
Change the measurement range of the input channel. When this key is tapped, the rotary knob is enabled (the LED lights up) and the range can be selected by turning the knob.

- (8) L.P.F.: Change the low-pass filter of the input channel. When this key is tapped, the rotary knob is enabled (the LED lights up) and the filter can be selected by turning the knob.

- (9) A.A.F.: Turns the anti-aliasing filter of the input channel on or off.

- (10) Disp. pos.: Specify the position of the waveform monitor to display the specified range of the waveform display area. Specified as a percentage indicating the center position of the display range from the bottom of the graph when the full range of each graph is 100%.

- (11) Disp. range: Specifies the display width in the amplitude direction of each graph. Specified (by tapping the key and turning the knob) as the percentage of the display width with the full range of each graph at is 100%.

- (12) Disp. min: Set (by tapping the key and turning the knob) the display lower limit value (scale value) of the bottom of the display range.

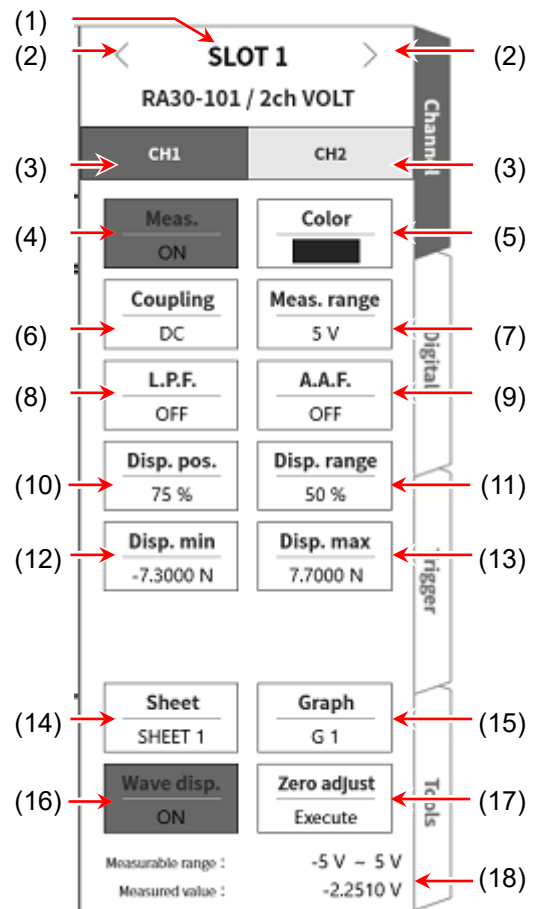

- (13) Disp. max: Set (by tapping the key and turning the knob) the display upper limit value (scale value) of the top of the display range.
- (14) Sheet: Set the monitor display/printer print sheet of the set channel.
- (15) Graph: Set the graph.
When this key is tapped, the rotary knob is enabled (the LED lights up) and the graph can be changed by turning the knob.
- (16) Waveform display area:
When enabled, the waveform is displayed. When disabled, the waveform is not displayed.
- (17) Zero adjust: Cancels the input offset of the input channel. Execute zero cancellation to perform more accurate measurement.
- (18) Available measurement range/measurement value:
Displays the current available measurement range and measurement value.

9.1.3. Measurement Setup

Check the slot number and channel, connect the signal to the corresponding input module, and enable the **【 Meas.】** key to display the input waveform on the monitor screen. Perform adjustment for the required signal waveform while viewing the waveform.

Follow the procedure below to set the input channel.

Step 1. Set the input coupling with the **【 Coupling】** key (6).

Coupling	Contents
DC	Enables measurement of the actual input signal, including the DC and AC component.
AC	Measures the AC component of the input signal only. Set this when you want to measure only the amplitude of an AC signal, as it cancels the DC offset of the signal.
GND	Connects the channel input to GND without connecting the input signal inside the channel. Enables the input GND level to be checked with waveform monitoring or printer recording.

* When switching from DC coupling to AC coupling during measurement, it takes about 12 seconds for the DC component to completely disappear.

Step 2. Set Meas. range according to the target for measurement.

The input sensitivity can be changed with the **【 Meas. range】** key (7) in the channel setup sub menu.

The value displayed for the measurement range (RANGE) indicates the input (measurement) maximum value and corresponds to 10 div on the waveform monitor. When the display position is 50%, \pm RANGE (full measurement range) is displayed.

Tap the **【 Meas. range】** key and turn the rotary knob to change the range. Turn the rotary knob counterclockwise to reduce the sensitivity and clockwise to increase the sensitivity.

The following 12 measurement ranges are available.

500 V	200 V	100 V	50 V	20 V	10 V	5 V	2 V	1 V	500 mV	200 mV	100 mV
-------	-------	-------	------	------	------	-----	-----	-----	--------	--------	--------

When the input exceeds the measurement range, "OVER RANGE" is displayed on the bottom right of the screen, and the main unit emits a warning beep. Reduce the sensitivity with the measurement range so that the input signal does not exceed the range. To emit a warning beep, enable the buzzer setting. See "[8.2.5. Environment Setup](#)".

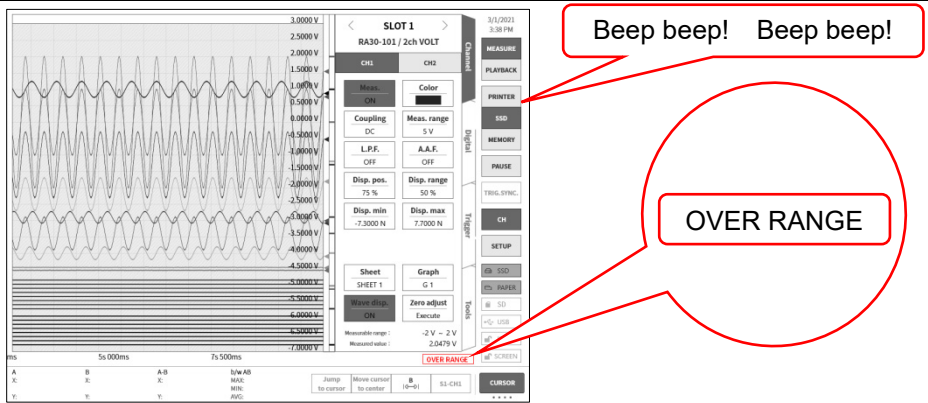

Step 3. Set the input filter.

Set the low-pass filter with the **【L.P.F.】** key (8).

The low-pass filter of this module is a gently sloping attenuation filter that prioritizes the waveform. Set a cutoff frequency about 10 times the effective frequency as a signal to remove the unnecessary high frequency component and noise component.

OFF	3 kHz	300 Hz	30 Hz	3 Hz
-----	-------	--------	-------	------

Set the antialiasing filter setting with the **【A.A.F.】** key (9).

A steeply sloping attenuation low-pass filter. Enable this filter to automatically set the cutoff frequency linked with the sampling speed so that aliasing does not occur in the measurement data due to the sampling. This is particularly effective for FFT analysis. The L.P.F. setting is disabled because L.P.F. is used internally.

Step 4. Set the display range and display position.

See "[Description of Step 4 \(setting the display range and display position \(waveform display area\)\)](#)" in "[04.2.2. Setup the input channels](#)".

Disp. range: The display width in the amplitude direction of the waveform display area on the waveform monitor

Disp. pos.: Specify the position of the waveform monitor to display the specified range of the waveform display area.

Step 5. Set the display minimum and display maximum.

See "[Description of Step 5 \(setting the display maximum and display minimum \(waveform display scale\)\)](#)" in "[04.2.2. Setup the input channels](#)".

Disp. max: Set the display upper limit value of the top of the display range.

Disp. min: Set the display lower limit value of the bottom of the display range.

Step 6. Execute zero adjust.

After turning on the power, changes in the surrounding temperature as time elapses change the internal temperature of the RA3100 main unit, and cause temperature drift inside the input module, which leads to errors in measurements due to variation in the DC offset voltage. Execute zero adjust to minimize these errors.

To perform zero cancellation, tap the **【Zero adjust】** key (14) after waiting for a warm-up period of 60 minutes.

NOTE

- This function is for canceling internal offset and drift, and does not cancel the offset of the input signal.

9.1.4. Reference Materials

⚠ CAUTION

- Ensure that the voltage between each input and the chassis (GND) and between each channel does not exceed 300 V AC or DC. (Damage may be caused if the voltage is exceeded.)

1 Input cable

The input connectors for CH1 and CH2 are insulated BNC connectors. Do not connect metallic BNC plugs, as they may damage the connectors or cause connection problems.

Use the insulated BNC cable indicated below (RA30-507) as the signal input cables.

Recommended cables

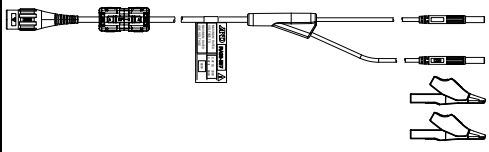
Name (type)	Shape/characteristics	Remarks
Insulated BNC cable (safety alligator clip) RA30-507		Insulated BNC ⇕ Safety alligator clip Red + Black - Length 1.5 m + 0.2 m
		RA30-101 RA30-102 RA30-103 Analog input

2 Maximum rated voltage to ground

RA3100 main unit Input module

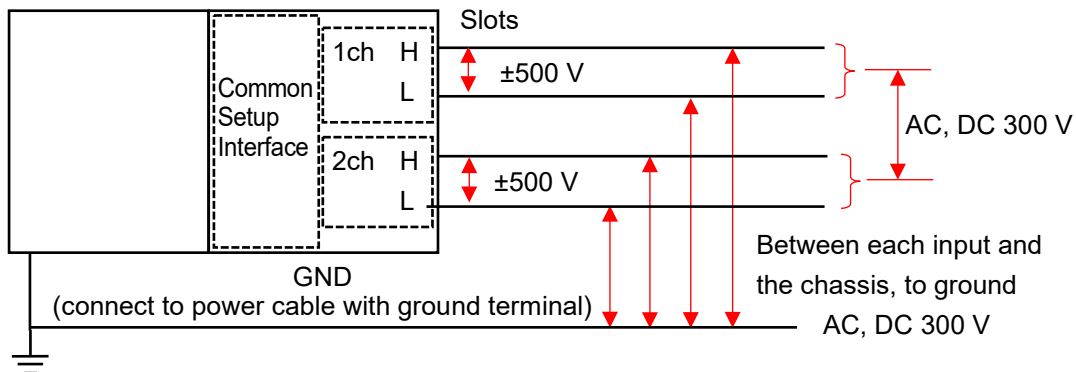

9.2. Four Channel Voltage Module (RA30-102)

9.2.1. Overview

This four channel voltage input module samples a DC to 100 kHz signal at 16-bit 1 MS/s within the measurement range of ± 1 V to ± 200 V and can perform A/D conversion. It includes an analog filter for waveform observation. It is insulated between each channel and between input and output.

9.2.2. Setting the Input Channel

<This section describes the setting switches and setting values of the RA3100 main unit. >

- (1) Slot number, input module type
- (2) Change slot: You can change the display slot by swiping this sub menu left or right or tapping the left [**<**] and right [**>**] key.
- (3) Select channel: Tap [**CH1**] to [**CH4**] in the slots and select the channel to set.
- (4) Meas. ON/OFF
ON: Measure and record the input signal.
- (5) Color: Change the display color of the waveform monitor.
- (6) Coupling: Switch the input signal coupling in the order DC → GND. Tap the key and turn the rotary knob to select.
- (7) Meas. range: Change the measurement range of the input channel.
When this key is tapped, the rotary knob is enabled (the LED lights up) and the range can be selected by turning the knob.
- (8) L.P.F.: Change the low-pass filter of the input channel.
When this key is tapped, the rotary knob is enabled (the LED lights up) and the filter can be selected by turning the knob.
- (10) Disp. pos.: Specify the position of the waveform monitor to display the specified range of the waveform display area. Specified as a percentage indicating the center position of the display range from the bottom of the graph when the full range of each graph is 100%.
- (11) Disp. range: Specifies the display width in the amplitude direction of each graph. Specified (by tapping the key and turning the knob) as the percentage of the display width with the full range of each graph at 100%.
- (12) Disp. min: Set (by tapping the key and turning the knob) the display lower limit value (scale value) of the bottom of the display range.
- (13) Disp. max: Set (by tapping the key and turning the knob) the display upper limit value (scale value) of the top of the display range.
- (14) Sheet: Set the monitor display/printer print sheet of the set channel.

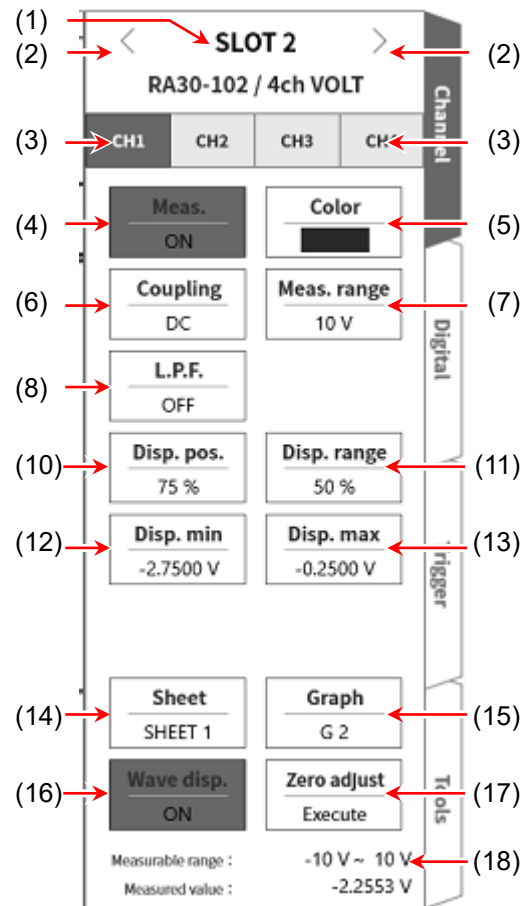

- (15) Graph: Set the graph. When this key is tapped, the rotary knob is enabled (the LED lights up) and the graph can be changed by turning the knob.
- (16) Waveform display: When enabled, the waveform is displayed in the waveform monitor. When disabled, the waveform is not displayed.
- (17) Zero adjust: Cancels the input offset of the input channel. Execute zero cancellation to perform more accurate measurement.
- (18) Available measurement range/measurement value: Displays the current available measurement range and measurement value.

9.2.3. Measurement Setup

Check the slot number and channel, connect the signal to the corresponding input module, and enable **【 Meas.】** to display the input waveform on the monitor screen. Perform adjustment for the required signal waveform while viewing the waveform.

Follow the procedure below to set the input channel.

Step 1. Set the input coupling in with the **【 Coupling】** key (6).

Coupling	Contents
DC	Enables measurement of the actual input signal, including the DC and AC component. Set DC coupling when performing measurement.
GND	Connects the channel input to GND without connecting the input signal inside the channel. Enables the input GND level to be checked with waveform monitoring or printer recording.

Step 2. Set Meas. range according to the target for measurement.

The input sensitivity can be changed with the **【 Meas. range】** key (7) in the channel setup sub menu. The value displayed for the measurement range (RANGE) indicates the input (measurement) maximum value and corresponds to 10 div on the waveform monitor. When the display position is 50%, \pm RANGE (full measurement range) is displayed.

Tap the **【 Meas. range】** key and turn the rotary knob to change the range. Turn the rotary knob counterclockwise to reduce the sensitivity and clockwise to increase the sensitivity. The following 8 measurement ranges are available.

200 V	100 V	50 V	20 V	10 V	5 V	2 V	1 V
-------	-------	------	------	------	-----	-----	-----

When the input exceeds the measurement range, "OVER RANGE" is displayed on the bottom right of the screen, and the main unit emits a warning beep. Reduce the sensitivity with the measurement range so that the input signal does not exceed the range. To emit a warning beep, enable the buzzer setting. See "[8.2.5. Environment Setup](#)".

Step 3. Set the input filter. Set the low-pass filter with the **【 L.P.F.】** key (8).

The low-pass filter of this module is a gently sloping attenuation filter that prioritizes the waveform. Set a cutoff frequency about 10 times the effective frequency as a signal to remove the unnecessary high frequency component and noise component.

OFF	3 kHz	300 Hz	30 Hz	3 Hz
-----	-------	--------	-------	------

- Step 4. Set the display range and display position.
See "[Description of Step 4 \(setting the display range and display position \(waveform display area\)\)](#)" in "[4.2.2. Setup the input channels](#)".
Disp. range: The display width in the amplitude direction of the waveform display area on the waveform monitor
Disp. pos.: Specify the position of the waveform monitor to display the specified range of the waveform display area.
- Step 5. Set the display minimum and display maximum.
See "[Description of Step 5 \(setting the display maximum and display minimum \(waveform display scale\)\)](#)" in "[4.2.2. Setup the input channels](#)".
Disp. max: Set the display upper limit value of the top of the display range.
Disp. min: Set the display lower limit value of the bottom of the display range.
- Step 6. Execute zero adjust.
After turning on the power, changes in the surrounding temperature as time elapses change the internal temperature of the RA3100 main unit, and cause temperature drift inside the input module, which leads to errors in measurements due to variation in the DC offset voltage. Execute zero adjust to minimize these errors.
To perform zero cancellation, tap the **【 Zero adjust 】** key (14) after waiting for a warm-up period of 60 minutes.

NOTE

- This function is for canceling internal offset and drift, and does not cancel the offset of the input signal.

9.2.4. Reference Materials

⚠ CAUTION

- Ensure that the voltage between each input and the chassis (GND) and between each channel does not exceed 300 V AC or DC. (Damage may be caused if the voltage is exceeded.)

1 Input cable

The input connectors for CH1 to CH2 are insulated BNC connectors. Do not connect metallic BNC plugs, as they may damage the connectors or cause connection problems.

Use the insulated BNC cable indicated below (RA30-507) as the signal input cables.

Recommended cables

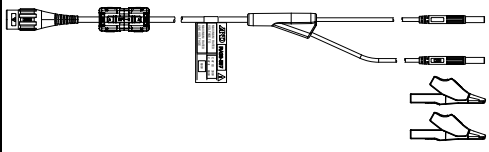
Name (type)	Shape/characteristics	Remarks	
Insulated BNC cable (safety alligator clip) RA30-507		Insulated BNC ↕ Safety alligator clip Red + Black - Length 1.5 m + 0.2 m	RA30-101 RA30-102 RA30-103 Analog input

2 Maximum rated voltage to ground

RA3100 main unit Input module

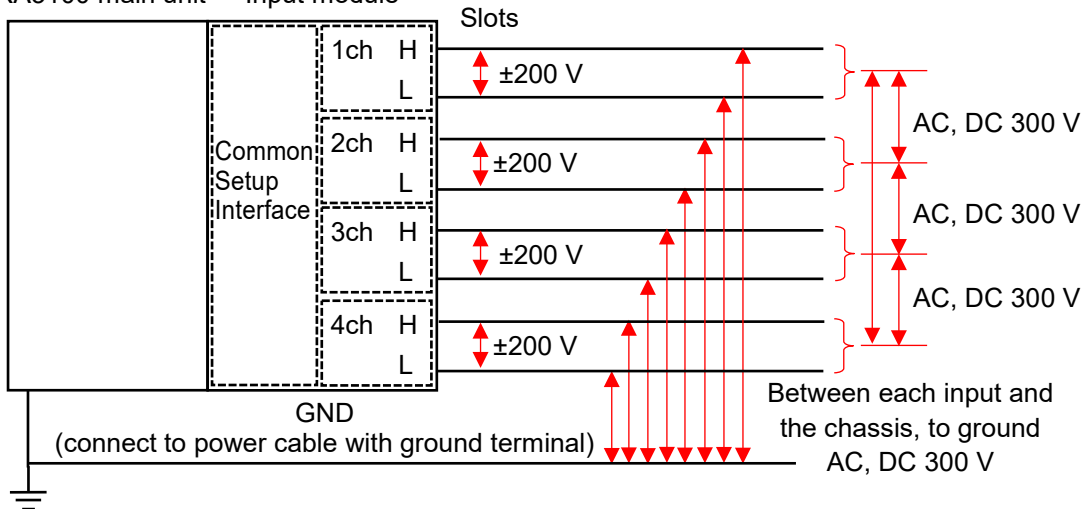

9.3. Two Channel High-Speed Voltage Module (RA30-103)

9.3.1. Overview

This two channel voltage input module samples a DC to 5 MHz signal at 16-bit 20 MS/s within the measurement range of ± 100 mV to ± 500 V and can perform A/D conversion. It includes an antialiasing filter used for FFT processing and analog filter for waveform observation. It is insulated between each channel and between input and output.

9.3.2. Setting the Input Channel

<This section describes the setting switches and setting values of the RA3100 main unit. >

- | | | | |
|--|--------|--------|--------|
| (1) Slot number, input module type | (1) → | (1) → | (2) ← |
| (2) Change slot: You can change the display slot by swiping this sub menu left or right or tapping the left [<] and right [>] key. | (2) → | (2) → | (2) ← |
| (3) Select channel:
Select the channel in the slot. | (3) → | (3) → | (3) ← |
| (4) Meas. ON/OFF
ON: Measure and record the input signal. | (4) → | (4) → | (5) ← |
| (5) Color: Change the display color of the waveform monitor. | (6) → | (6) → | (7) ← |
| (6) Coupling: Switch the input signal coupling in the order DC → GND → AC. Tap the key and turn the rotary knob to select. | (6) → | (6) → | (7) ← |
| (7) Meas. range: Change the measurement range of the input channel.
When this key is tapped, the rotary knob is enabled (the LED lights up) and the range can be selected by turning the knob. | (8) → | (8) → | (11) ← |
| (8) L.P.F.: Change the low-pass filter of the input channel.
When this key is tapped, the rotary knob is enabled (the LED lights up) and the filter can be selected by turning the knob. | (10) → | (10) → | (11) ← |
| (10) Disp. pos.: Specify the position of the waveform monitor to display the specified range of the waveform display area. Specified as a percentage indicating the center position of the display range from the bottom of the graph when the full range of each graph is 100%. | (12) → | (12) → | (13) ← |
| (11) Disp. range: Specifies the display width in the amplitude direction of each graph.
Specified (by tapping the key and turning the knob) as the percentage of the display width with the full range of each graph at 100%. | (14) → | (14) → | (15) ← |
| (12) Disp. min: Set (by tapping the key and turning the knob) the display lower limit value (scale value) of the bottom of the display range. | (16) → | (16) → | (17) ← |
| (13) Disp. max: Set (by tapping the key and turning the knob) the display upper limit value (scale value) of the top of the display range. | (16) → | (16) → | (17) ← |
| (14) Sheet: Set the monitor display/printer print sheet of the set channel. | (16) → | (16) → | (18) ← |
| (15) Graph: Set the graph. When this key is tapped, the rotary knob is enabled (the LED lights up) and the graph can be changed by turning the knob. | (16) → | (16) → | (18) ← |

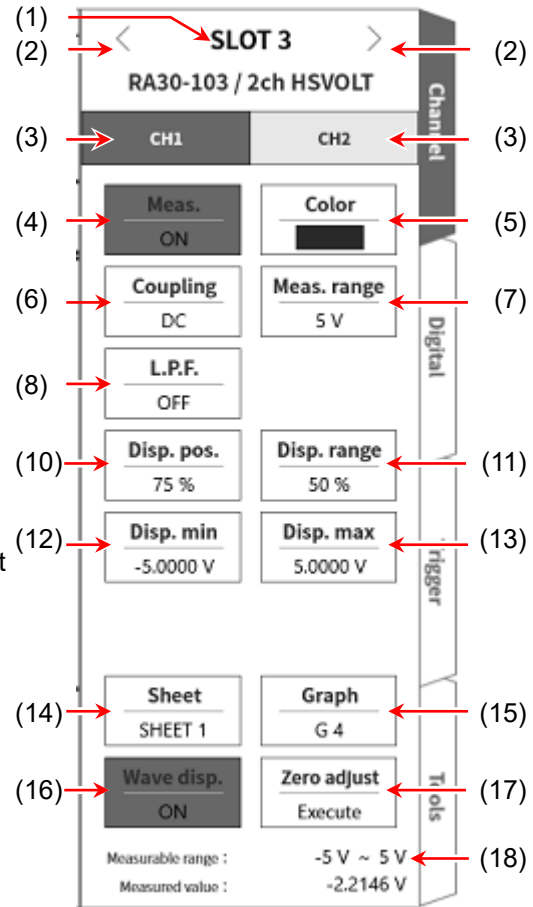

(16) Waveform display:

When enabled, the waveform is displayed in the waveform monitor. When disabled, the waveform is not displayed.

(17) Zero adjust: Cancels the input offset of the input channel. Execute zero cancellation to perform more accurate measurement.

(18) Available measurement range/measurement value:

Displays the current available measurement range and measurement value.

9.3.3. Measurement Setup

Check the slot number and channel, connect the signal to the corresponding input module, and enable **【 Meas.】** to display the input waveform on the monitor screen. Perform adjustment for the required signal waveform while viewing the waveform.

Follow the procedure below to set the input channel.

Step 1. Set the input coupling in with the **【 Coupling】** key (6).

Coupling	Contents
DC	Enables measurement of the actual input signal, including the DC and AC component. Set DC coupling when performing measurement.
AC	Measures the AC component of the input signal only. Set this when you want to measure only the amplitude of an AC signal, as it cancels the DC offset of the signal.
GND	Connects the channel input to GND without connecting the input signal inside the channel. Enables the input GND level to be checked with waveform monitoring or printer recording.

Step 2. Set Meas. range according to the target for measurement.

The input sensitivity can be changed with the **【 Meas. range】** key (7) in the channel setup sub menu.

The value displayed for the measurement range (RANGE) indicates the input (measurement) maximum value and corresponds to 10 div on the waveform monitor. When the display position is 50%, \pm RANGE (full measurement range) is displayed.

Tap the **【 Meas. range】** key and turn the rotary knob to change the range. Turn the rotary knob counterclockwise to reduce the sensitivity and clockwise to increase the sensitivity. The following 12 measurement ranges are available.

500 V	200 V	100 V	50 V	20 V	10 V	5 V	2 V	1 V	500 mV	200 mV	100 mV
-------	-------	-------	------	------	------	-----	-----	-----	--------	--------	--------

When the input exceeds the measurement range, "OVER RANGE" is displayed on the bottom right of the screen, and the main unit emits a warning beep. Reduce the sensitivity with the measurement range so that the input signal does not exceed the range. To emit a warning beep, enable the buzzer setting. See "[8.2.5. Environment Setup](#)".

Step 3. Set the input filter. Set the low-pass filter with the **【 L.P.F.】** key (8).

The low-pass filter of this module is a gently sloping attenuation filter that prioritizes the waveform. Set a cutoff frequency about 10 times the effective frequency as a signal to remove the unnecessary high frequency component and noise component.

OFF	500 kHz	50 kHz	5 Hz
-----	---------	--------	------

Step 4. Set the display range and display position.

See "[Description of Step 4 \(setting the display range and display position \(waveform display area\)\)](#)" in "[4.2.2. Setup the input channels](#)".

Disp. range: The display width in the amplitude direction of the waveform display area on the waveform monitor

Disp. pos.: Specify the position of the waveform monitor to display the specified range of the waveform display area.

Step 5. Set the display minimum and display maximum.

See "[Description of Step 5 \(setting the display maximum and display minimum \(waveform display scale\)\)](#)" in "[4.2.2. Setup the input channels](#)".

Disp. max: Set the display upper limit value of the top of the display range.

Disp. min: Set the display lower limit value of the bottom of the display range.

Step 6. Execute zero adjust.

After turning on the power, changes in the surrounding temperature as time elapses change the internal temperature of the RA3100 main unit, and cause temperature drift inside the input module, which leads to errors in measurements due to variation in the DC offset voltage. Execute zero adjust to minimize these errors.

To perform zero cancellation, tap the **【 Zero adjust 】** key (14) after waiting for a warm-up period of 60 minutes.

NOTE

- This function is for canceling internal offset and drift, and does not cancel the offset of the input signal.

9.3.4. Reference Materials

1 Input cable

The input connectors for CH1 and CH2 are insulated BNC connectors. Do not connect metallic BNC plugs, as they may damage the connectors or cause connection problems.

Use the insulated BNC cable indicated below (RA30-507) as the signal input cables.

Recommended cables

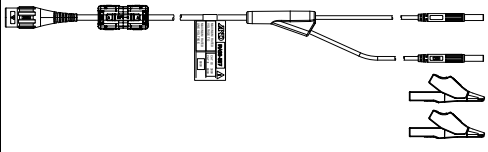
Name (type)	Shape/characteristics	Remarks
Insulated BNC cable (safety alligator clip) RA30-507		Insulated BNC ↓ Safety alligator clip Red + Black - Length 1.5 m + 0.2 m
		RA30-101 RA30-102 RA30-103 Analog input

2 Input frequency and input voltage derating characteristics

A maximum of 1000 Vp-p can be input for the voltage and 5 MHz for the frequency, but there are restrictions on the relationship between the voltage and frequency. These set limits to avoid damage to devices and enable safe measurement.

Increased device heat and input voltage may damage the signal source and device.

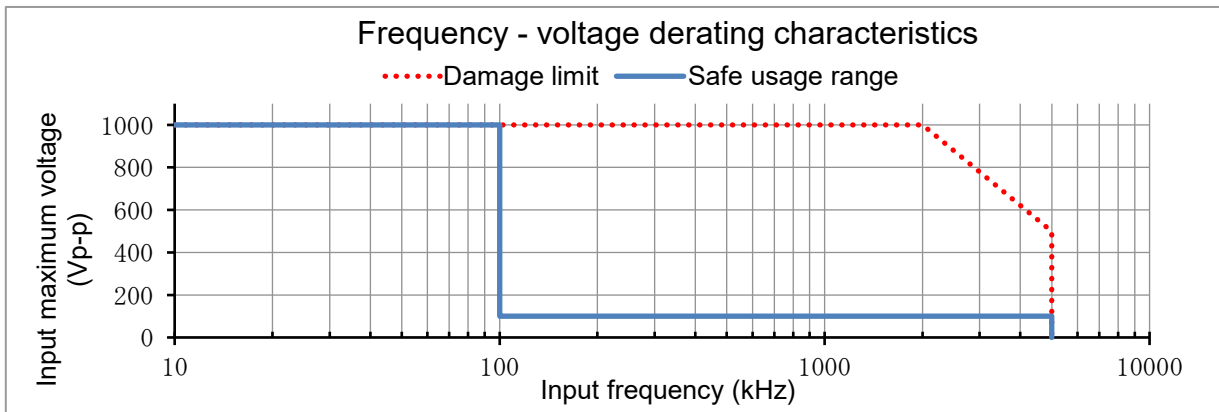

3 Maximum rated voltage to ground

RA3100 main unit

Input module

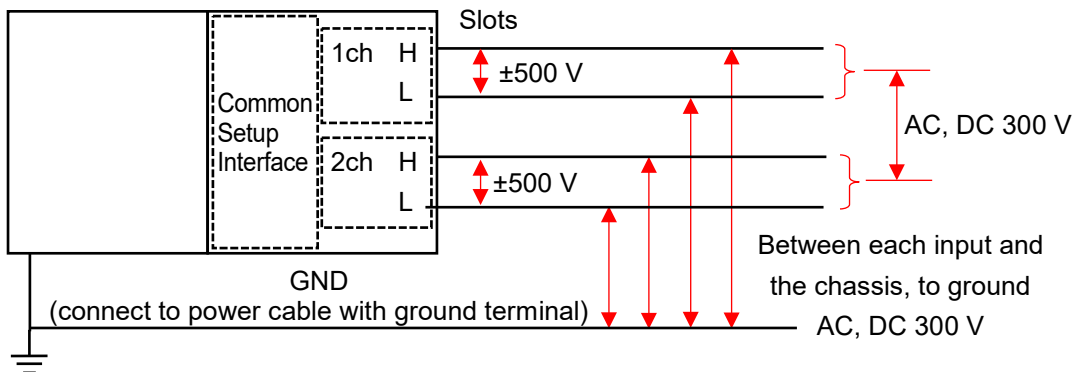

⚠ CAUTION

- ❑ Use the product within the safe usage range.
With 1000 Vp-p 100 kHz, note that the input current will be approximately 21 mA, which will place a load on the signal source.
- ❑ Ensure that the voltage between each input and the chassis (GND) and between each channel does not exceed 300 V AC or DC. (Damage may be caused if the voltage is exceeded.)

9.4. 16 Channel Logic Module (RA30-105)

9.4.1. Overview

This module is a logic measurement module that converts 16 channels (8 channels x 2) of input signals into high level or low level logic signals according to a threshold. It supports voltage (high level /low level) detection and non-voltage contact (open/close) of input signals. Pulses can respond at 1 μs or lower. 16 channel data synchronizes for measurement and recording. The probe that can connect to this module is an optional 1539S floating voltage probe for recording the existence of 100 V or 200 V system voltage and the 1540S and 1543S voltage conversion probes for recording voltage increases and decreases for AC 100 V systems and AC 200 V systems.

9.4.2. Setting the Input Channel

The Input signal setting of this module differs for voltage and contact, as indicated below.

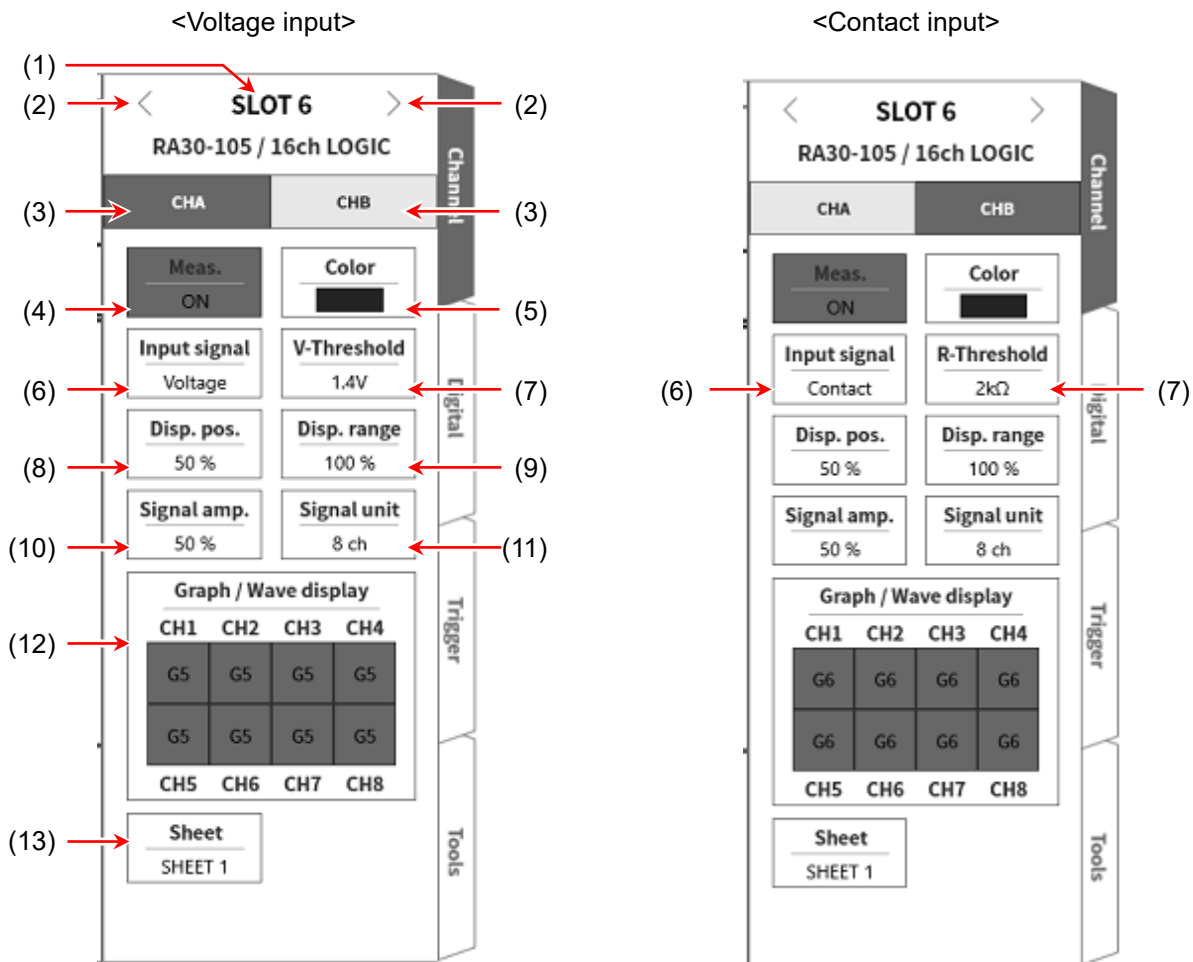

- (1) Slot number, input module type
- (2) Change slot: You can change the display slot by swiping this sub menu left or right or tapping the left [<] and right [>] key.
- (3) Select channel: Tap [CHA] and [CHB] in the slots and select the channel.
- (4) Meas. ON/OFF
ON: Measure and record the input signal.
- (5) Color: Change the display color of the waveform monitor.
- (6) Input signal: Select voltage or contact. This setting can be selected for both CHA (8 ch) and CHB (8 ch).

- (7) Threshold setting: When **【 Input signal】** is set to voltage, **【 V-Threshold】** (7) can be set. Three types of threshold for voltage detection can be selected. When **【 Input signal】** is set to contact, **【 R-Threshold】** (7) can be set. Three types of threshold for contact detection can be selected.
- (8) Disp. pos.: Sets the display position for the logic signal of CHA or CHB. The low level position of CH-4 is the set value.
- (9) Disp. range: Sets the display amplitude for the logic signal of CHA or CHB. Specified as the percentage of the display width when the full range of each graph is 100%. The eight channel signals are displayed at equal intervals and the overall display width can be set.
- (10) Signal amplitude: Sets the high level (waveform) height as a percentage to the low level of each channel. An example of the display for each signal unit is indicated in the figure below.

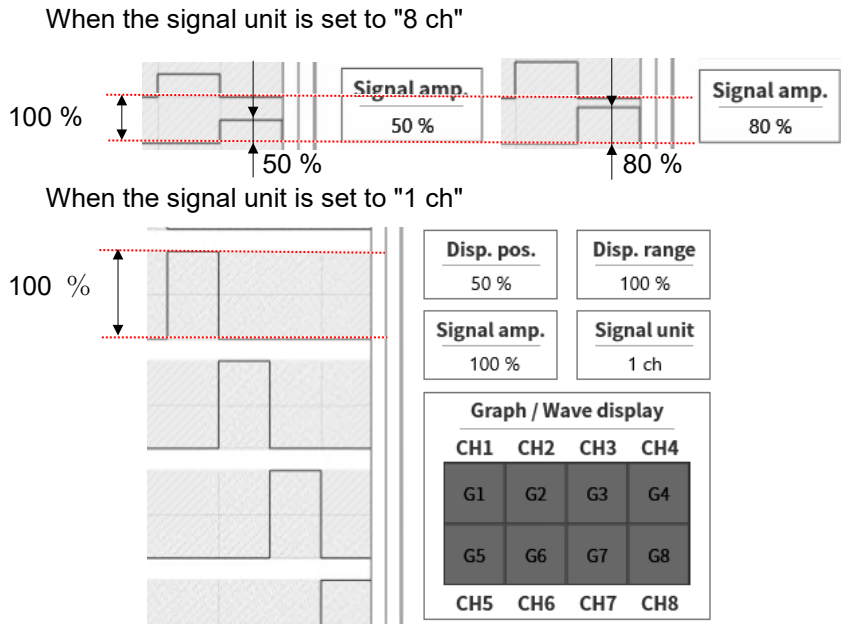

- (11) Signal unit: Sets whether to assign channels to the graph on a single channel basis or eight channel basis. When the signal unit is set to "8 ch", assign channels on a CHA or CHB basis (eight channels at a time). When the signal unit is set to "1 ch", assign channels for CH1 to CH8 basis (one channel at a time). For information on channel assignment, see ["SHEET1/SHEET2/SHEET3"](#) in ["8.1.3 Sheet Setup"](#).
- (12) Graph/Wave display: Tap inside the Graph/Wave display frame to display the setting dialog. Set G1 to G18 for the graph using the graph keys. When waveform display is enabled, the waveform is displayed in the waveform monitor. When disabled, the waveform is not displayed.

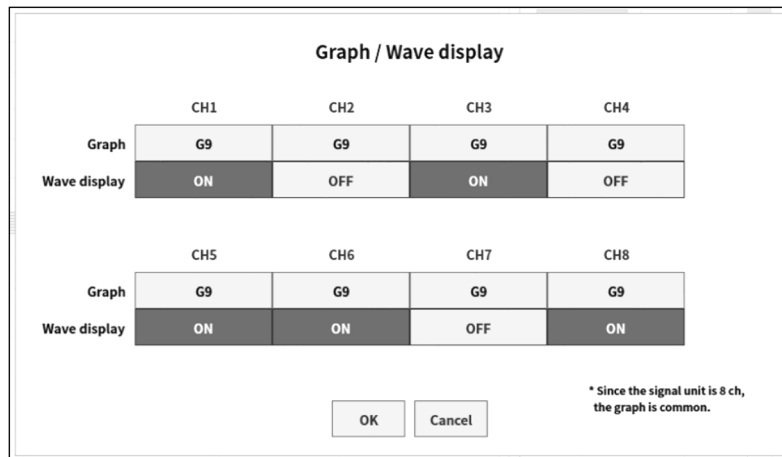

(13) Sheet: Displays the sheet number when using monitor display or printer recording for CHA or CHB. You can tap SHEET to change the sheet number.

9.4.3. Measurement Setup

⚠ CAUTION

□ The maximum voltage input is 24 V.
Take care, as applying high voltage can damage the module.
Use the 1539S floating voltage probe when inputting high voltage.

Check the slot number and channel, connect the signal to the corresponding input module, and enable **【 Meas.】** to display the input waveform on the monitor screen. Perform adjustment for the required signal waveform while viewing the waveform.
Follow the procedure below to set the input CHA and input CHB.

Step 1. Select voltage or contact in **【 Input signal】** (6).
For voltage input, the high/low state of the voltage is displayed as binary data with the waveform indicating the high level/low level.
For contact connection, the open/closed state of the non-voltage contact is displayed as binary data with the waveform indicating the high level/low level.

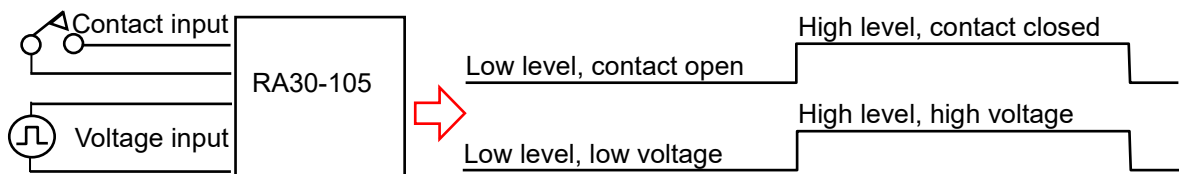

Step 2. Set **【 Threshold value】** (7) according to the target for measurement.
1.4 V, 2.5 V, or 4 V can be selected as the threshold for voltage input.
The resistance value between contacts is used as the threshold for contact connection, as indicated in the table. Select the setting using the threshold when open.

Non-voltage contact closed (ON)	High level	250 Ω or lower	1.5 kΩ or lower	3.0 kΩ or lower
Non-voltage contact open (OFF)	Low level	2.0 kΩ or higher	5.0 kΩ or higher	9.0 kΩ or higher

* A load current of about 0.5 mA flows.

Step 3. Set the channel for monitor display or printer recording in **【 Display signal】** (10).

Step 4. Set **【 Disp. pos.】** (8) and **【 Disp. range】** (9).

9.4.4. Reference Materials

1 Pin layout of input connector

This module can input 16 channels, but eight channels are grouped in CHA and CHB, respectively. The input, trigger, and waveform display settings are set separately for CHA and CHB. The connectors are also separate for CHA and CHB.

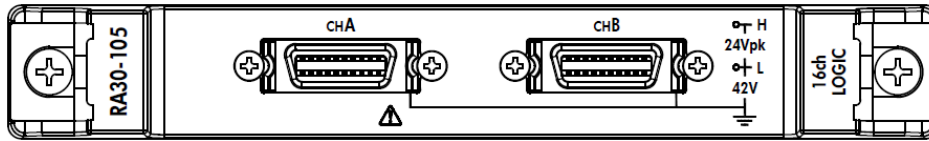

CHA connector

Pin number	Sig name	Pin number	Sig name
A1	+5VA2	B1	GND
A2	+5VA2	B2	
A3	CH8	B3	
A4	CH7	B4	
A5	CH6	B5	
A6	CH5	B6	
A7	CH4	B7	
A8	CH3	B8	
A9	CH2	B9	
A10	CH1	B10	

CHB connector

Pin number	Sig name	Pin number	Sig name
A1	+5VA2	B1	GND
A2	+5VA2	B2	
A3	CH8	B3	
A4	CH7	B4	
A5	CH6	B5	
A6	CH5	B6	
A7	CH4	B7	
A8	CH3	B8	
A9	CH2	B9	
A10	CH1	B10	

- * Connector for input signal: DF02R020NA3 (Japan Aviation Electronics Industry)
- * The A series and B series are complementary. GND (B series) is the input common for A series signals.
- * The plugs (manufacturer model numbers) corresponding to each input signal connector are indicated below.
Compatible plug: DF02P020F22A1 (soldered type), DF02P020G28A1 (pressure connected type)

2 Maximum rated voltage to ground

RA3100 main unit Input module

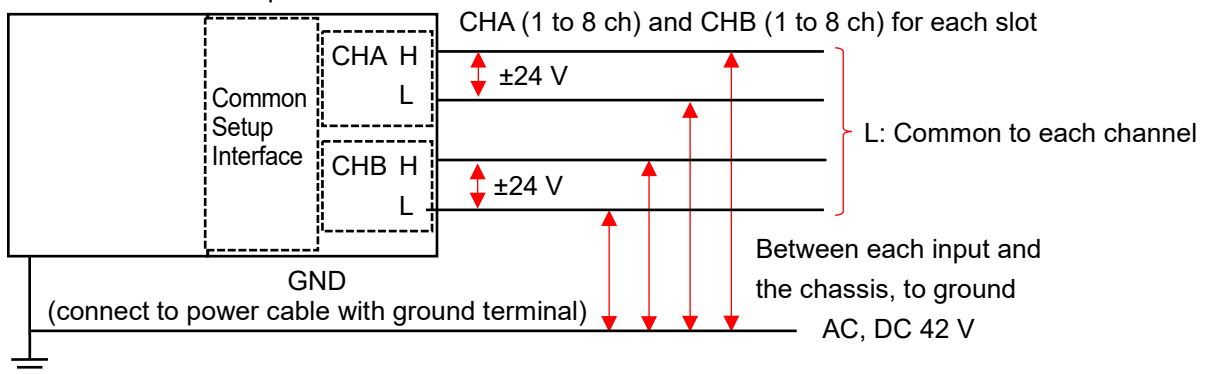

CAUTION

- Ensure that the voltage between each input and the chassis (GND) does not exceed 42 V AC or DC. (Damage may be caused if the voltage is exceeded.)
There is no insulation between the inputs. L (GND) is connected internally.

9.4.5. Options

1 Connection cables and terminal blocks

The following cables, terminal blocks, and probes are provided for signal input.

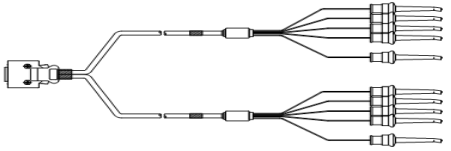
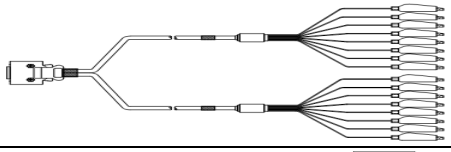
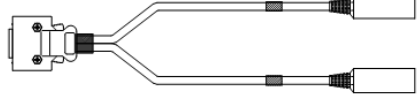
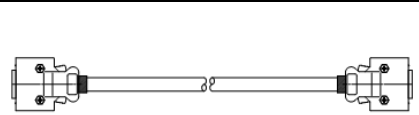
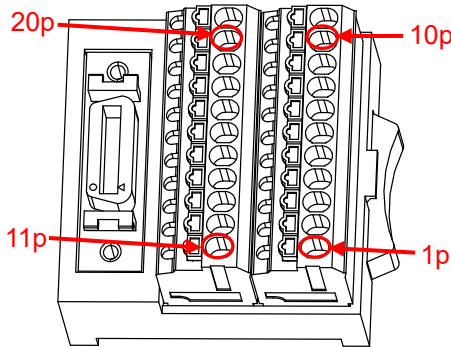
Name (type)	Shape/characteristics	Adaptation	
8 channel logic cable (IC clip) RA30-501		For logic input 4CH x 2, shared ground 1.5 m	RA30-105
8 channel logic cable (alligator clip) RA30-502		For logic input 4CH x 2 1.5 m	RA30-105
Rectangular to mini DIN Conversion cable RA30-503		For 1539S connection Length 0.3 m	RA30-105
Terminal block connection cable RA30-504		For MDR 20 pole terminal block connection 20P - 20P Length 2 m	RA30-105 RA30-112
Terminal block AX-PCX-10S20		For MDR 20 pole terminal block (for AWG16-28) 1 to 10: A1 to A10 11 to 20: B1 to B10	RA30-105 RA30-112

2 Probe

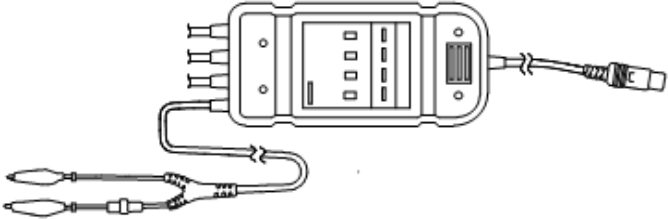
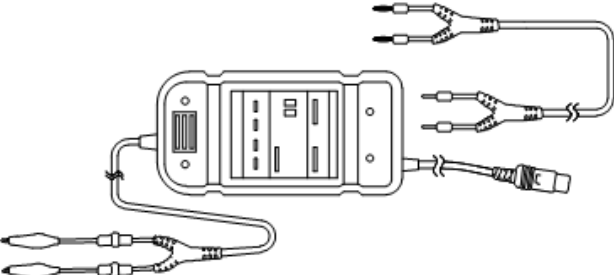
Name (type)	Shape	Adaptation
Floating voltage probe 1539S		RA30-105 Rectangular to mini DIN Conversion cable Connected to RA30-503 Four inputs
Probe for voltage variation 1540S: AC100/120V 1543S: AC220/240V		RA30-105 Rectangular to mini DIN Conversion cable Connected to RA30-503 One input

9.5. Two Channel Temperature Module (RA30-106)

9.5.1. Overview

This module is a two channel temperature measurement module that can set three measurement ranges for each thermocouple (TC) and platinum resistance temperature detector (RTD) sensor, and perform 16-bit sampling with a three-stage data update rate to enable A/D conversion. It includes functions for switching the internal/external reference junction and checking for disconnections. It is insulated between each channel and between input and output, to safely support general temperature measurement.

9.5.2. Setting the Input Channel

The settings differ according to whether **【 Sensor 】** (1) is set to the thermocouple (TC) or platinum resistance temperature detector (RTD) type.

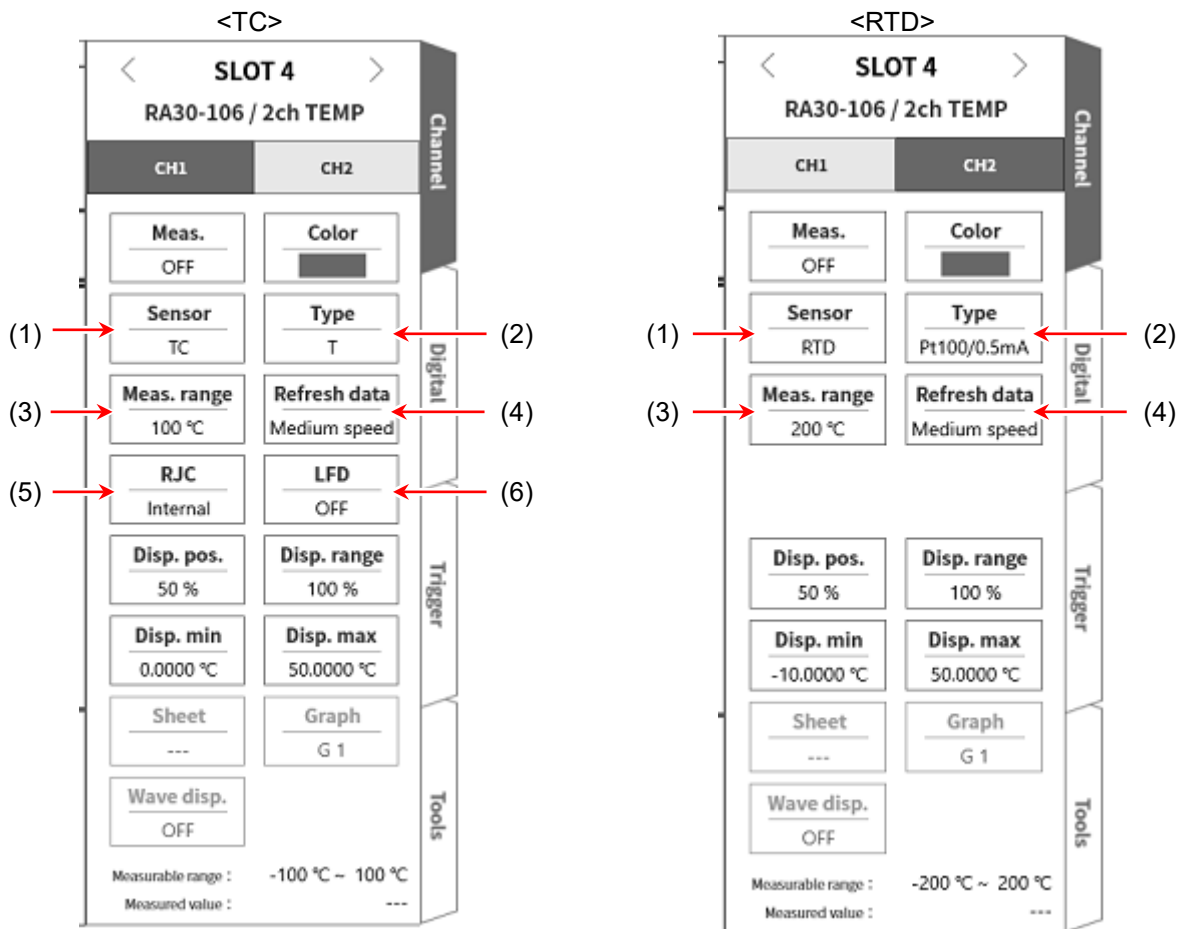

- (1) Sensor: Select [TC] or [RTD] as the sensor type.
- (2) Type: For a thermocouple (TC) sensor, select K, E, J, T, N, R, S, B, or C as the thermocouple (TC) to connect.
For RTD, select Pt100 (1 mA), Pt100 (0.5 mA), or Pt1000 (0.1 mA).
- (3) Meas. range: Set the temperature range to measure. Three types of ranges can be selected for each sensor type.
- (4) Refresh data: Select low speed (1 s), medium speed (100 ms), or high speed (1.5 ms) as the data update speed.
- (5) RJC: Select [Internal] to directly connect the sensor when using a thermocouple (TC).
When placing the reference junction (cooling point) outside, select [External] to perform temperature compensation.

- (6) LFD: Set [ON] or [OFF]. When set to [ON], the output goes over the scale when there is a disconnection.
- Other: The **【 Meas.】**, **【 Color】**, **【 Disp. pos.】**, **【 Disp. range】**, **【 Disp. min】**, **【 Disp. max】**, **【 Sheet】**, **【 Graph】**, available setting ranges, and measurement value settings are the same as for other modules.

9.5.3. Measurement Setup

Check the slot number and channel, and set the sensor type, etc. to use for the corresponding input module.

Follow the procedure below to set the input channel.

- Step 1. Select thermocouple (TC) and platinum resistance temperature detector (RTD) sensor in **【 Sensor】**, and set the sensor type in **【 Type】**.
- Step 2. Connect the signal and enable **【 Meas.】** to display the input waveform on the monitor screen. Perform adjustment for the required signal waveform while viewing the waveform.
- Step 3. Set **【 Meas. range】** according to the target for measurement.
The value displayed for the measurement range (RANGE) indicates the maximum value of the temperature to input (measure).
For temperature measurement, the minimum value of the measured value differs from +RANGE. Check the actual measurement range in [Measurable range].
- Step 4. Set the **【 Refresh data】**.
Select high speed, medium speed, or low speed as the data refresh rate.
With low speed (1s), the response speed is slower but there is less variation in data and accurate measurement can be performed.
At medium speed (100 ms), the data is updated 10 times per second. This provides more stable measurement accuracy than with high speed.
With high speed (1.5 ms), the response speed is faster and quickly changing temperatures can be measured. The measurement certainty specifications are also fulfilled with high speed.
- Step 5. Set **【 RJC】**.
When connecting a reference junction device such as a ZERO-CON, set it to [External].
When set to [Internal], measure the temperature of the front panel to use as the reference junction.
- Step 6. Set **【 LFD】**.
- Step 7. Set the display range and display position.
See "[Description of Step 4 \(setting the display range and display position \(waveform display area\)\)](#)" in "[4.2.2. Setup the input channels](#)".
Disp. range: The display width in the amplitude direction of the waveform display area on the waveform monitor
Disp. pos.: Specify the position of the waveform monitor to display the specified range of the waveform display area.
- Step 8. Set the display minimum and display maximum.
See "[Description of Step 5 \(setting the display maximum and display minimum \(waveform display scale\)\)](#)" in "[4.2.2. Setup the input channels](#)".
Disp. max: Set the display upper limit value of the top of the display range.
Disp. min: Set the display lower limit value of the bottom of the display range.

NOTE

- When the sampling speed of this product is lower than the data update time of this module, the same data is output during the update period.

9.5.4. Reference Materials

⚠ CAUTION

- ❑ Do not connect something other than a sensor (thermocouple (TC) or platinum resistance temperature detector) to an input terminal.
(Do not input voltage or current. Doing so may lead to failure.)
- ❑ Ensure that the voltage between each input and the chassis (GND) and between each channel does not exceed 300 V AC or DC. (Damage may be caused if the voltage is exceeded.)
- ❑ When measuring a location with electric potential using a non-insulated thermocouple (TC) or platinum resistance temperature detector, never touch the metallic parts of the input wire, as electric potential occurs in the cable itself.

1 Front panel

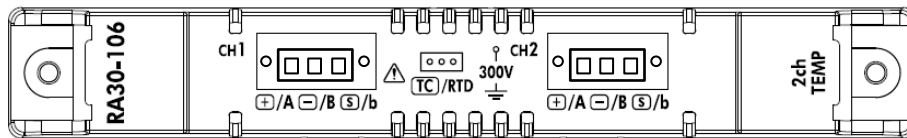

2 Thermocouple (TC) sensor connection method

2.1 Connection terminal

After screwing the thermocouple (TC) into the temperature sensor connector, insert it into the connector of the front panel.

The terminal names of the input connectors are indicated on the left side of the panel as +, -, and S.

+ /A terminal	Connect the + side wire of the thermocouple (TC).
- /B terminal	Connect the - side wire of the thermocouple (TC).
S /b terminal	Terminal for shielding. Connect the sheath (shield) wire of the non-contact type sheathed thermocouple (TC). Leave the S terminal unconnected for the grounded type.

NOTE

- ❑ When using the non-contact type sensor, the S terminal must be insulated from the + terminal and - terminal.
If they are connected, correct measurement will not be able to be performed and failure may occur.
- ❑ The thermocouple (TC) has a + and - side. Connect them correctly.
(Correct measurement will not be able to be performed if the + and - sides are switched.)
- ❑ Make sure the resistance value of the thermocouple (TC) is 1 kΩ or less.
- ❑ Use a compatible extension wire for thermocouple (TC) extension.
- ❑ Connect a single thermocouple (TC) to a single channel.
- ❑ Wire the thermocouple (TC) cable away from the power line and sources of noise.

2.2 Thermocouple (TC) sensor connection diagram

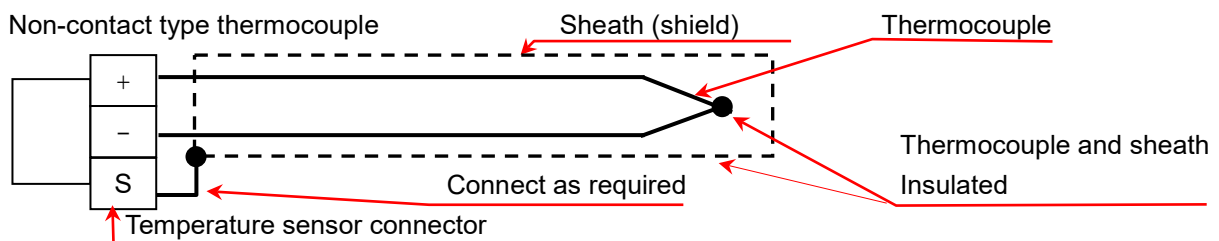

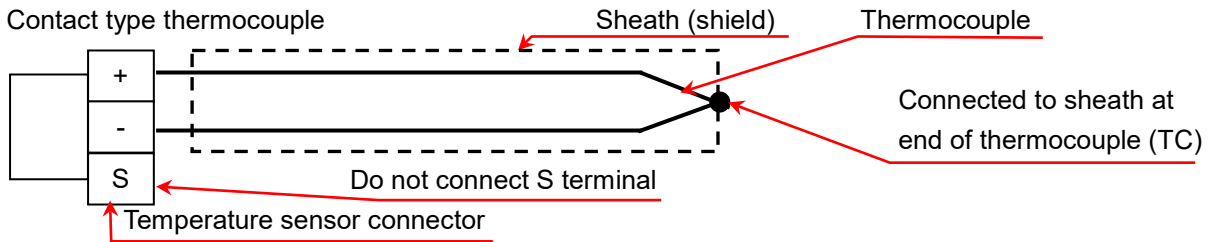

2.3 Types and characteristics of thermocouples (TC)

Thermocouple (TC)	Characteristics	Disadvantages
B	High usage temperature.	Cannot measure low temperatures at or below 0°C.
R, S	Suitable for precise measurement in oxidizing atmospheres and inert gas at high temperatures. Good precision and little variation or deterioration. Used as standard thermocouple (TC).	The electromotive force characteristic has poor linearity. Poor linearity of electromotive force characteristic. Cannot measure low temperatures at or below 0°C.
N	Stable thermo-electromotive force at a wide range of temperatures from low temperature to high temperature	
K	Good linearity of thermo-electromotive force and suitable for oxidizing atmospheres. Most common for industrial use.	Poor linearity of electromotive force characteristic.
E	High thermo-electromotive force.	
J	High thermo-electromotive force, for industrial use and medium range temperatures.	Poor linearity of electromotive force characteristic.
T	Stable thermo-electromotive force and suitable for precision measurement at low temperatures.	Low maximum usage temperature.
C	Suitable for reducing atmospheres, inert gases, and hydrogen gas.	Cannot be used in air.

3 Platinum resistance temperature detector (RTD) sensor connection method

3.1 Connection terminal

After screwing the platinum resistance temperature detector into the temperature sensor connector, insert it into the connector of the front panel. The terminal names of the input connectors are indicated on the right side of the panel as A, B, and b.

<input type="checkbox"/> +/A terminal	Connect the A side wire of the platinum resistance temperature detector (RTD).
<input type="checkbox"/> -/B terminal	Connect the B side wire of the platinum resistance temperature detector (RTD).
<input type="checkbox"/> S/b terminal	Connect the b side wire of the platinum resistance temperature detector (RTD).

NOTE

- Make sure to use a three-wire type platinum resistance temperature detector (RTD) sensor.
- Use three equal length cables for RTD extension in order to match the resistance values.
- Ensure the wire resistance is 10 Ω or less (per wire)
- Connect a single RTD to a single channel.
- Wire the RTD cable away from the power line and sources of noise.

3.2 Platinum resistance temperature detector (RTD) three wire sensor connection method

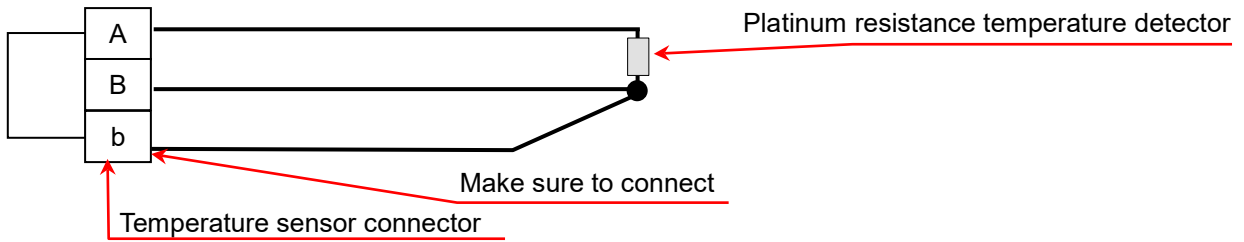

4 Sensor cable connection

- Step 1. Peel the coating of the sensor cable, and connect the cable to the socket.
 0.2 sq to 1.5 sq (AWG 24 to AWG 16) wire is supported.
 Insert the sensor cable from the right direction and tighten the top screw.
 Gently pull the cable and confirm that it does not become disconnected.

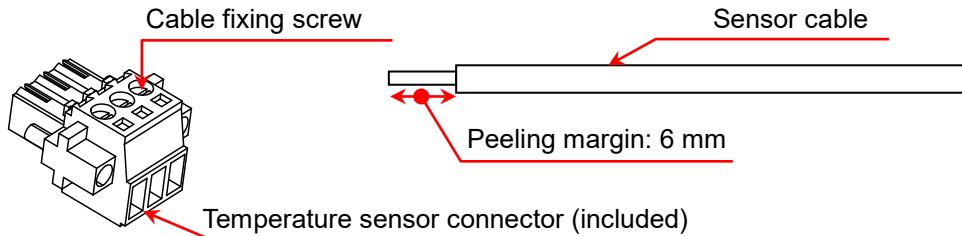

NOTE

- Cable fixing screw tightening torque: 0.2 Nm to 0.25 Nm
- Flat-blade screwdriver blade size: 0.4 m (thickness) x 2.5 mm (width)

- Step 2. Insert the top cable cover and bottom cable cover in the socket.
 Secure the cable from the bottom cable cover with a cable tie.

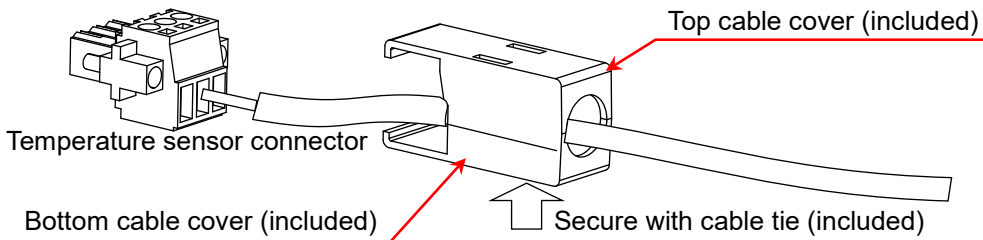

- Step 3. Connect the socket to the connector of the input panel.

- Step 4. Secure the socket to the connector of the input panel using the socket fixing screw.

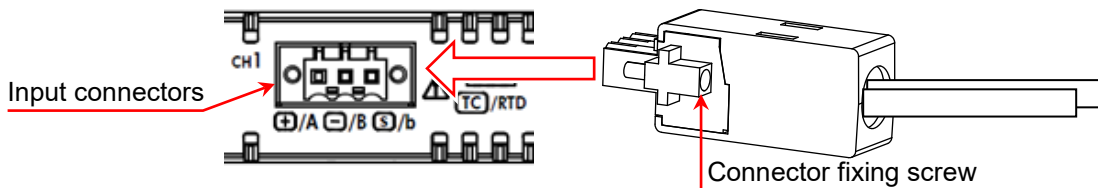

NOTE

- Socket fixing screw tightening torque: 0.2 Nm to 0.25 Nm
- The cable cover protects the terminal and cable fixing screw areas from static electricity, etc.

5 Reference junction compensation (RJC) when measuring thermocouple (TC)

Reference junction compensation is required when measuring the thermocouple (TC), and can be switched between internal and external compensation with this module.

Internal reference junction compensation measures the reference junction temperature at the module front panel.

When external compensation is set, it is necessary to externally perform 0°C reference junction compensation.

NOTE

- Perform measurement so that the temperature around the input connectors is stable.
- If there is a rapid change in the surrounding temperature, wait until the module temperature stabilizes (about one hour) and then start measurement.
- Ensure that the input connectors are not directly exposed to wind.
- Do not block the air holes of the front panel.

When performing external reference junction compensation

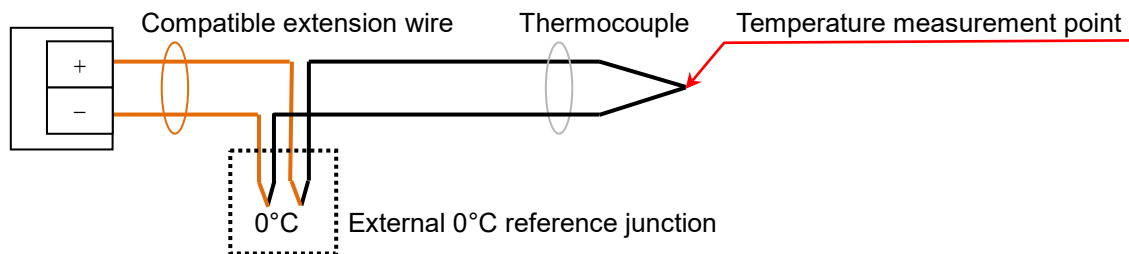

6 LFD function

This module has an LFD function that can be enabled or disabled when performing TC measurement. When enabled, 0.5 μA current is supplied and + side over range output occurs when the sensor is open (at 300 kΩ or higher). (Over range detects the possibility of a disconnection.)

NOTE

- When LFD is enabled, a temperature rise error will occur from the power consumption in the thermocouple (TC) resistance because a current of 0.5 μA is constantly supplied.
- It can be disabled when performing standard measurement to reduce the above error.
- When the setting is enabled, detection is possible when the open resistance is 300 kΩ or higher.

7 Maximum rated voltage to ground

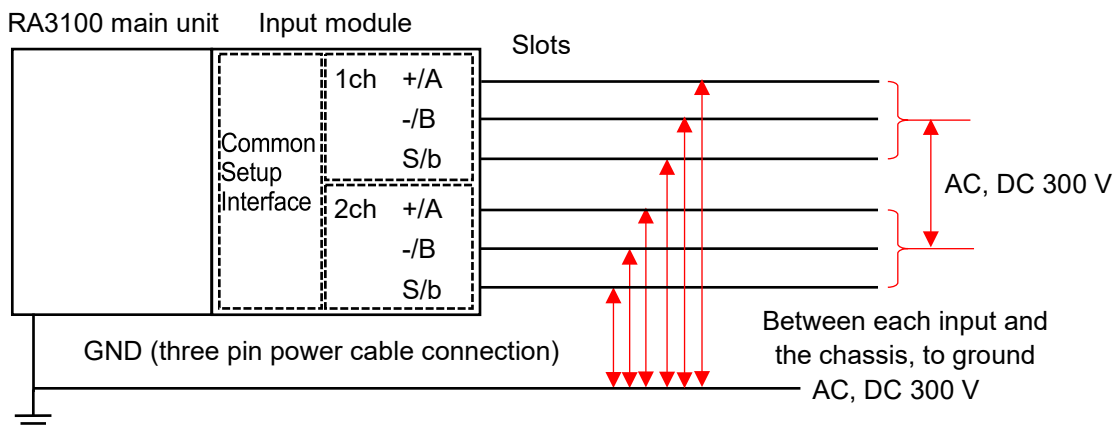

9.5.5. Spare Parts

Two sets of temperature sensor connectors are included as standard, and they can be connected to an alternate sensor in advance to allow easy changing.

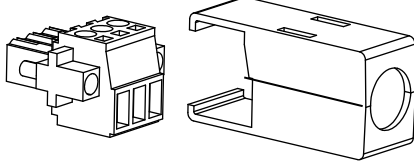
Name (type)	Shape/characteristics		Remarks
Temperature sensor connector Top cable cover Bottom cable cover Two sets of cable ties RA30-555			Can be connected/disconnected to/from the input connectors of the connector module for temperature sensor connection RA30-106

9.6. Remote Control Module (RA30-112)

9.6.1. Overview

The following three major types of functions are included in the RA30-112 remote module.

- ❑ Remote function for remotely controlling this product from an external device
- ❑ Carrier function for AC strain module
- ❑ Waveform confirmation output for confirming the voltage input module

The remote function includes both remote input for control from an external device and remote output for performing synchronized operation with another RA3100 and this product acting as the master.

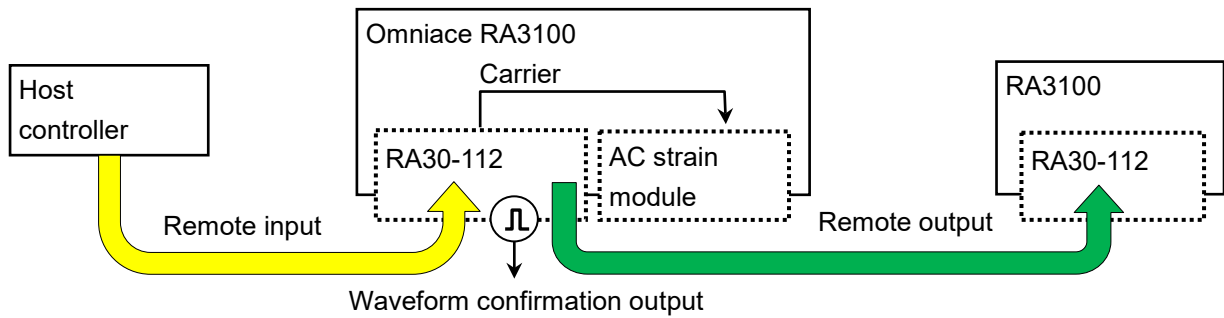

9.6.2. Installation

This module is installed to the input module block of this product as described in "2.1.2. Installing Optional Modules". This module differs from other modules in that it can only be installed to "SLOT 9". (Another module can be installed to "SLOT 9" if the RA30-112 is not installed.)

The RA30-112 can only be installed to SLOT 9.

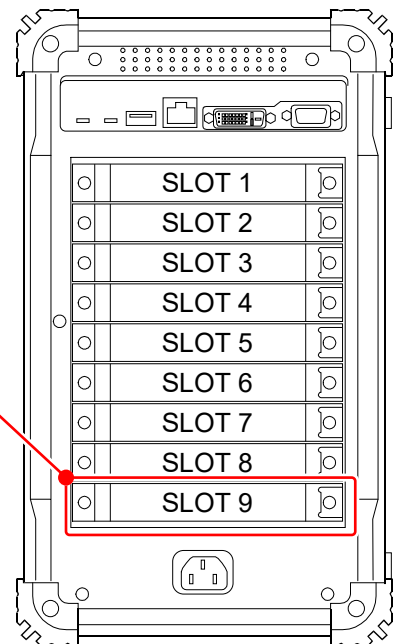

9.6.3. Channel setting

Tap the **[CH]** key on the **side menu** to display the channel settings menu. "SLOT 9" where the remote module (RA30-112) is installed in slot selection is displayed.

For information on functions, see "9.6.5 Measurement Setup".

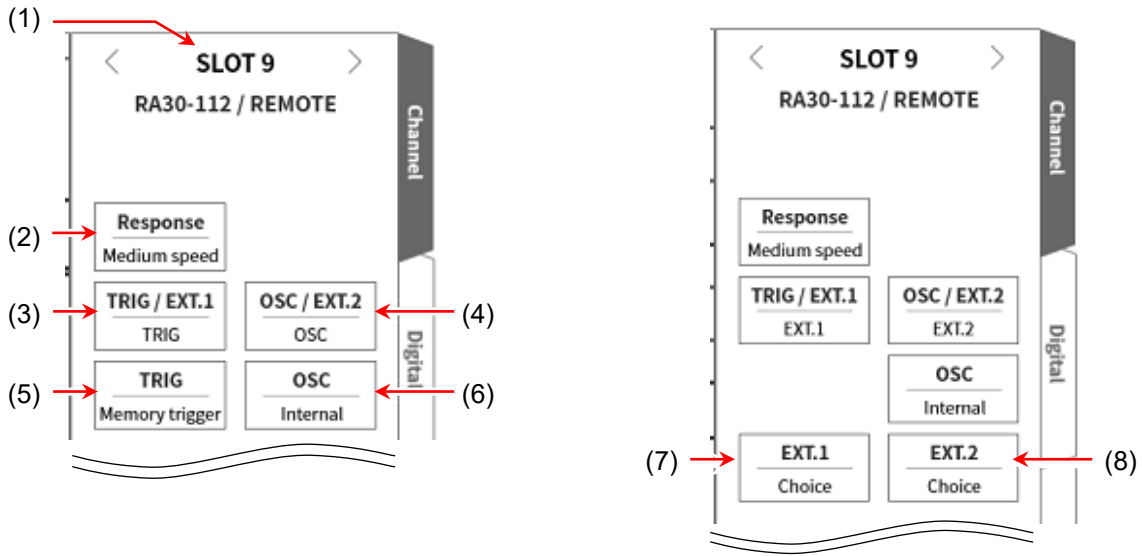

- (1) The slot number of SLOT 9.
- (2) Response: Select [High speed], [Medium speed], or [Low speed] for the response speed of the remote input signal.
- (3) TRIG/EXT.1: Select [TRIG] or [EXT.1]. Set TRIG in [TRIG] (5) and EXT.1 in [EXT.1] (7).
- (4) OSC/EXT.2: Select [OSC] or [EXT.2]. Set OSC in [OSC] (6) and EXT.2 in [EXT.2] (8).
- (5) TRIG: Sets the TRIG signal for remote input.
- (6) OSC: Select "Internal" or "External" as the carrier signal source for the AC strain module.
- (7) EXT.1: Enables/disables the state of this product set to output externally for system errors, printer errors, and overranges. Tap to display the EXT.1/EXT.2 setting dialog.
- (8) EXT.2: The same as EXT.1.

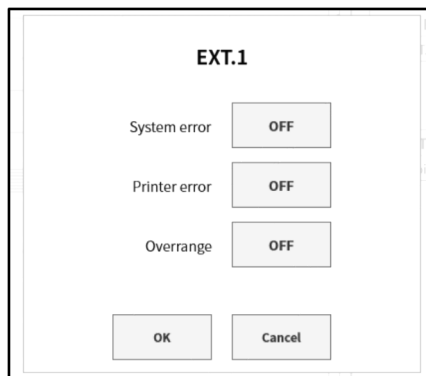

9.6.4. Output terminal for waveform confirmation

A square wave is output from the output terminal of this module at 0 to 5 V and 1 kHz.

This square wave signal can be connected to the voltage input module and waveform monitored to check module operation.

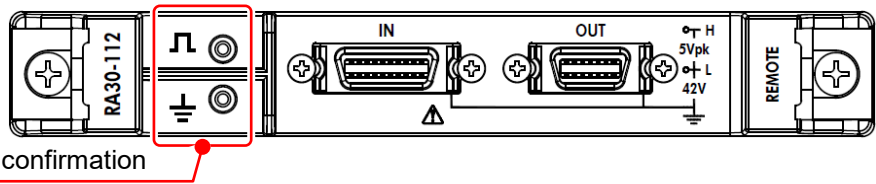

Output terminal for waveform confirmation

9.6.5. Measurement Setup

1 Response

Select [High speed], [Medium speed], or [Low speed] for the response speed of the remote input signal.

In noisy environments, select [Low speed] to perform control with a filter.

The effective pulse width of the input signal is as follows.

- For high speed response: High level period 1 μ s or more, Low level period 1 μ s or more
- For medium speed response: High level period 1 ms or more, Low level period 1 ms or more
- For low speed response: High level period 10 ms or more, Low level period 10 ms or more

2 OSC

Select the carrier signal source used for the RA3100 main unit when the AC strain module is installed.

Internal: Use the OSC signal generated in the RA3100 main unit where this module is installed.

It can also be supplied to another RA3100 connected with synchronization.

External: Supplies the OSC IN signal input from remote input to the implementation module.

See the connection diagram in "[5 Connection Method.](#)"

3 TRIG

Sets the TRIG signal for remote input.

- OFF: Do not use the TRIG signal for remote input.
- Start trigger: Input the TRIG signal for remote input as the start trigger.
- Memory trigger: Input the TRIG signal for remote input as the memory trigger.

4 EXT.1/EXT.2

These settings output the state of this product externally. When System error, Printer error, or Overrange is enabled, this is output if either one occurs.

- System error: The state where the software of this product cannot operate normally.
- Printer error: When a printer communication error, motor error, or head temperature error has occurred, the printer cover is open, or recording paper has run out.
- Overrange: When an overrange has occurred.

9.6.6. Reference Materials

1 Front panel

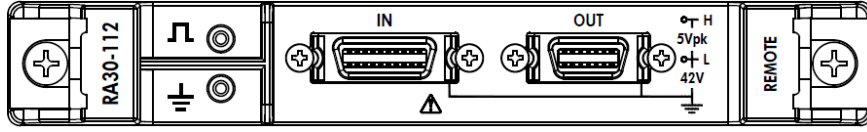

2 Pin layout of IN connector

Pin number	Sig name	Pin number	Sig name	Function
A1	NC	B1	GND	-
A2	NC	B2	GND	-
A3	START/STOP IN (+)	B3	START/STOP IN (-)	Recording start/stop input Performs printer recording for the period where the signal is at the low level.
A4	MARK IN (+)	B4	MARK IN (-)	Mark input Records a mark on the recording data at the falling edge of this signal.
A5	FEED IN (+)	B5	FEED IN (-)	Feed (idle feeding of recording paper) input Performs idle feeding of printer recording paper for the period where this signal is at the low level.
A6	PRINT IN (+)	B6	PRINT IN (-)	Print input Performs pen recording for the period where the signal is at the low level while stopped. This signal is not received during recording.
A7	NC	B7	GND	-
A8	EXT SMPL IN (+)	B8	EXT SMPL IN (-)	External sampling input Performs sampling at the falling edge of this signal.
A9	TRIG IN (+)	B9	TRIG IN (-)	Trigger input Receives external triggers at the falling edge of this signal.
A10	OSC IN (+)	B10	OSC IN (-)	OSC signal input for AC strain module Supplies this signal to the AC strain module as the carrier signal source.

- Connector for input signal: DF02R020NA3 (Japan Aviation Electronics Industry)
- The A series and B series are complementary. GND (B series) is the input common for A series signals.
- The plugs (manufacturer model numbers) corresponding to each input signal connector are indicated below.

Compatible plug: DF02P020F22A1 (soldered type), DF02P020G28A1 (pressure connected type)

3 Pin layout of out connector

Pin number	Sig name	Pin number	Sig name	Function
A1	START/ STOP OUT (+)	B1	START/ STOP OUT (-)	Recording start/stop output The low level signal is output while the product is recording.
A2	MARK OUT (+)	B2	MARK OUT (-)	Mark output Outputs the MARK IN signal to the MARK OUT signal.
A3	FEED OUT (+)	B3	FEED OUT (-)	Feed (idle feeding of recording paper) output Outputs the FEED IN signal to the FEED OUT signal.
A4	PRINT OUT (+)	B4	PRINT OUT (-)	Print output Outputs the PRINT IN signal to the PRINT OUT signal.
A5	EXT SMPL OUT	B5	EXT SMPL OUT	External sampling output Outputs the EXT SMPL IN signal to the EXT SMPL OUT signal.
A6	TRIG/EXT.1 OUT (+)	B6	TRIG/EXT.1 OUT (-)	Trigger output (TRIG OUT) Outputs the TRIG OUT signal to the low level when a trigger occurs. External output (EXT.1 OUT) Set to the low level when an error such as a system error occurs. See "9.6.3 Channel setting".
A7	OSC/EXT.2 OUT (+)	B7	OSC/EXT.2 OUT (-)	OSC signal for AC strain module output (OSC OUT) This output is used for synchronizing with the AC strain module installed in another RA3100. External output (EXT.2 OUT) Set to the low level when an error such as a system error occurs. See "9.6.3 Channel setting".

Connector for output signal: DF02R014NA3 (Japan Aviation Electronics Industry)

- The A series and B series are complementary. GND (B series) is the common for A series signals.
- The plugs (manufacturer model numbers) corresponding to each output signal connector are indicated below.

Compatible plug: DF02P014F22A1 (soldered type), DF02P014G28A1 (pressure connected type)

4 Maximum rated voltage to ground

RA3100 main unit Input module SLOT 9

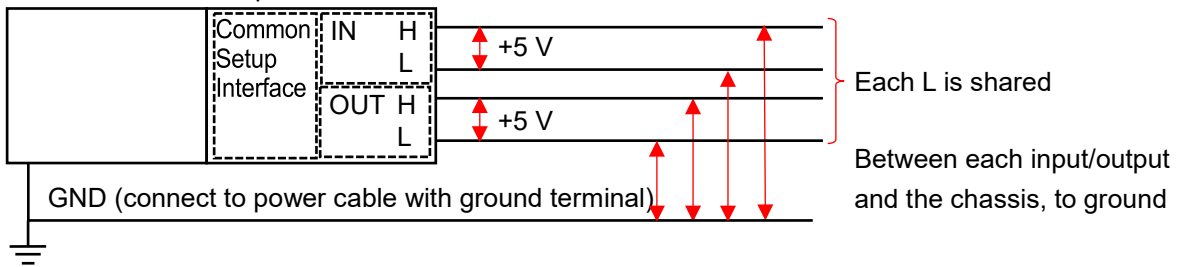

CAUTION

- ❑ Ensure that the voltage between each input/output and the chassis (GND) does not exceed 42 V AC or DC. (Damage may be caused if the voltage is exceeded.)
- ❑ There is no insulation between the inputs/outputs.
L (GND) is connected internally.

5 Connection method

5.1 For remote control

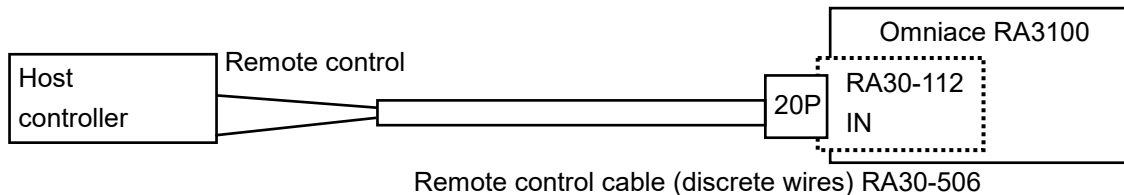
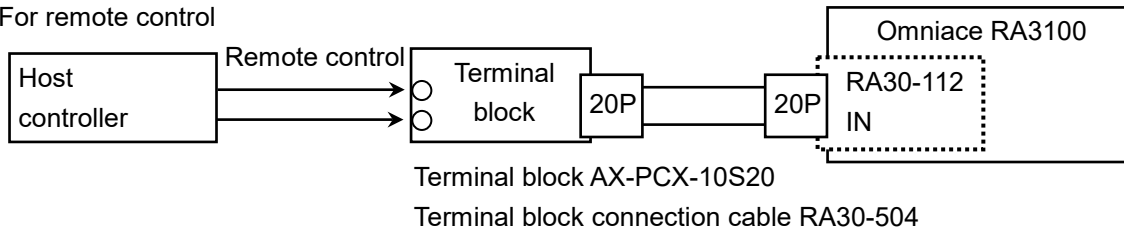

5.2 When connecting multiple RA3100

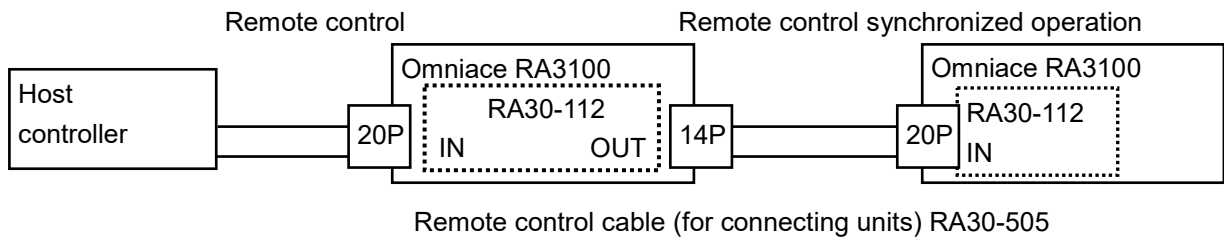

5.3 Carrier signal for AC strain

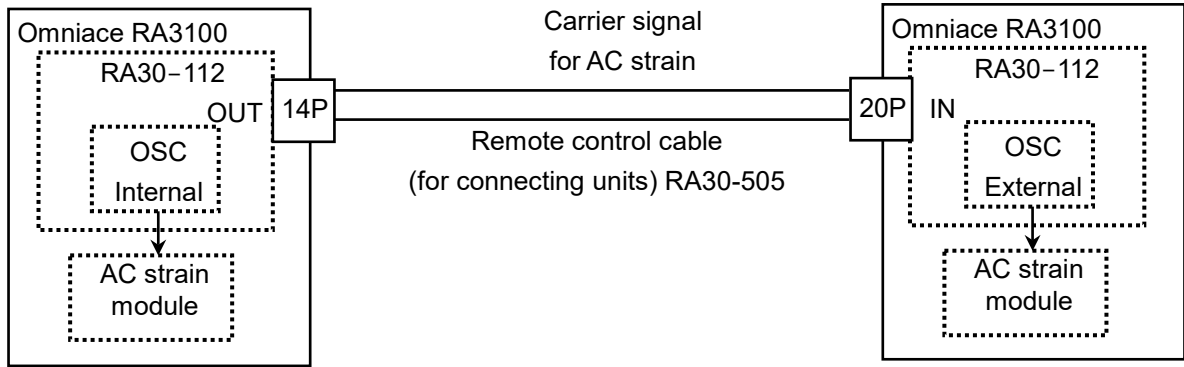

5.4 Output terminal for waveform confirmation

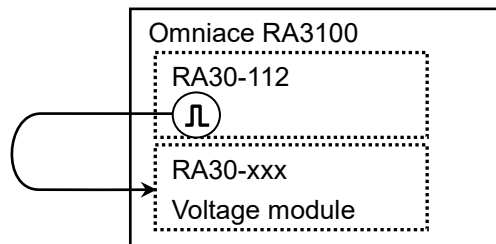

5.5 When monitoring the OUT signal

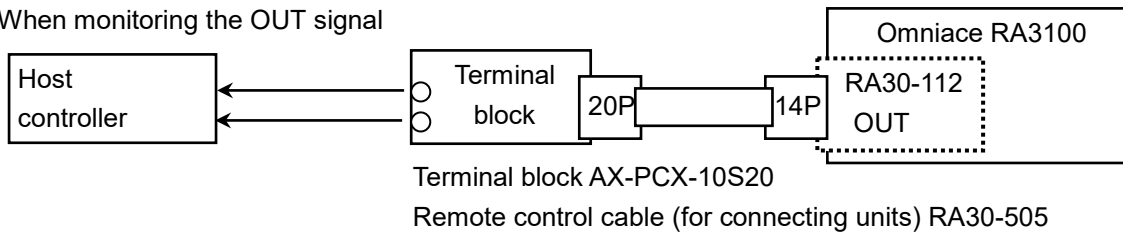

6 Equivalent circuit

6.1 IN

The equivalent circuit schematic of START/STOP IN, MARK IN, FEED IN, PRINT IN, EXT SMPL IN, TRIG IN, or OSC IN.

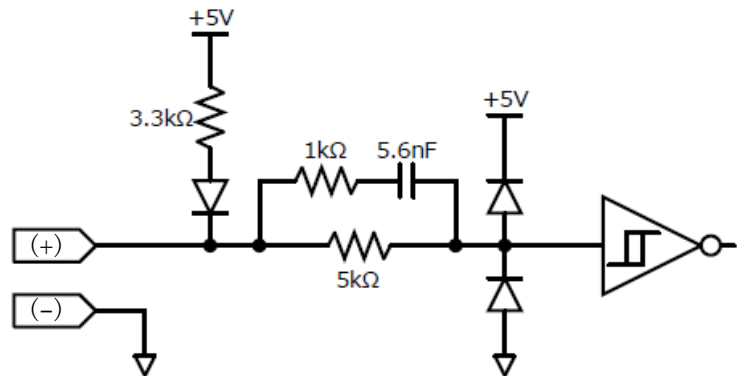

6.2 OUT

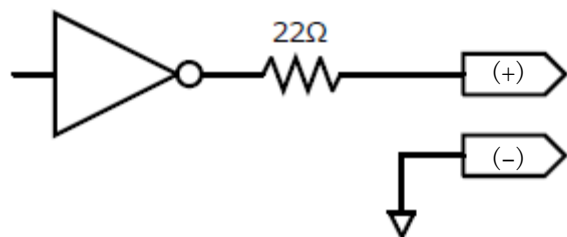

The equivalent circuit schematic of START/STOP OUT, FEED OUT, PRINT OUT, MARK OUT, TRIG OUT.



9.6.7. Options

1 Connection cables and terminal blocks

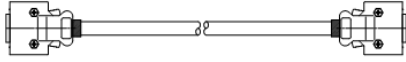
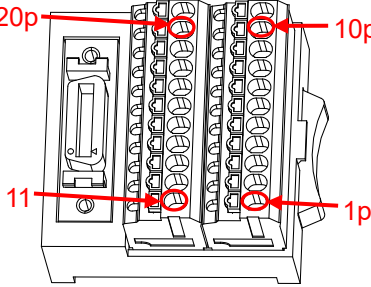
The following cables and terminal blocks are provided for signal input and synchronized connection.

Name (type)	Shape/characteristics	Adaptation
Terminal block connection cable RA30-504		For MDR 20 pole terminal block connection 20P - 20P Length 2 m
Terminal block AX-PCX-10S20		For MDR 20 pole terminal block (for AWG16-28)
Remote control cable (discrete wires) RA30-506		For remote control input Length 2 m
Remote control cable (for connecting units) RA30-505		For connecting RA3100 20P - 14P Length 2 m

2 Pin layout

Pin layout of RA30-112 input connectors and correspondence chart of remote control cables and terminal block connection cables.

Sig name	RA30-112 input terminal	Combination of AX-PCX-10S20 terminal block and RA30-504 cable	RA30-506 Remote control cable (discrete wires)		
	Pin no.	Pin no.	Wire color	Mark color	Mark indication
NC	A1	1			
GND	B1	11			
NC	A2	2			
GND	B2	12			
START/STOP IN	A3	3	Orange	Red	-
GND	B3	13		Black	-
MARK IN	A4	4	Light gray	Red	-
GND	B4	14		Black	-
FEED IN	A5	5	White	Red	-
GND	B5	15		Black	-
PRINT IN	A6	6	Yellow	Red	-
GND	B6	16		Black	-
NC	A7	7	Pink	Red	-
GND	B7	17		Black	-
EXT SMPL IN(+)	A8	8	Orange	Red	-
EXT SMPL IN(-)	B8	18		Black	-
TRIG IN(+)	A9	9	Light gray	Red	-
TRIG IN(-)	B9	19		Black	-
OSC IN(+)	A10	10	White	Red	-
OSC IN(-)	B10	20		Black	-

- Pin layout of RA30-112 OUT connectors and correspondence chart of remote control cables and terminal block connection cables.

	RA30-112 IN connector	Combination of AX-PCX-10S20 terminal block and RA30-505 cable
Sig name	Pin no.	Pin no.
START/STOP OUT (+)	A1	3
START/STOP OUT (-)	B1	11/13
MARK OUT (+)	A2	4
MARK OUT (-)	B2	14
FEED OUT (+)	A3	5
FEED OUT (-)	B3	15
PRINT OUT (+)	A4	6
PRINT OUT (-)	B4	16
EXT SMPL OUT (+)	A5	8
EXT SMPL OUT (-)	B5	18
TRIG/EXT.1 OUT (+)	A6	9
TRIG/EXT.1 OUT (-)	B6	19
OSC/EXT.2 OUT (+)	A7	10
OSC/EXT.2 OUT (-)	B7	20

3 Cable Specifications

3.1 RA30-504 Cable

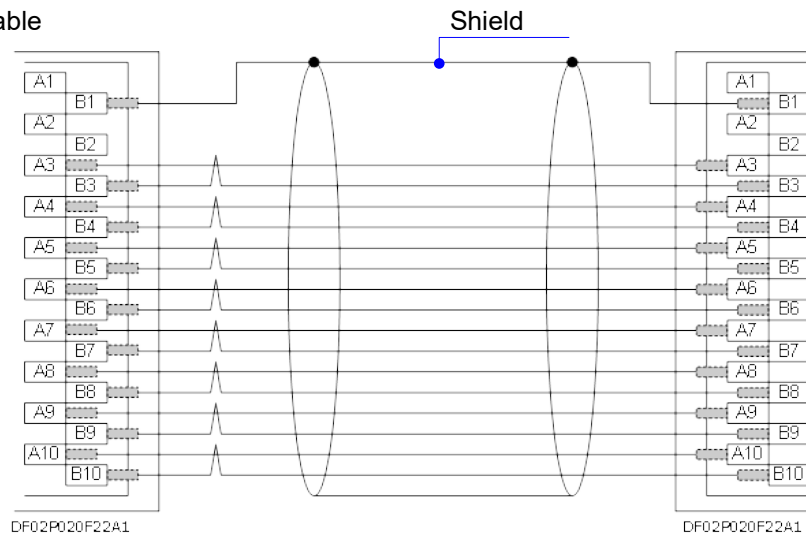

3.2 RA30-505 Cable

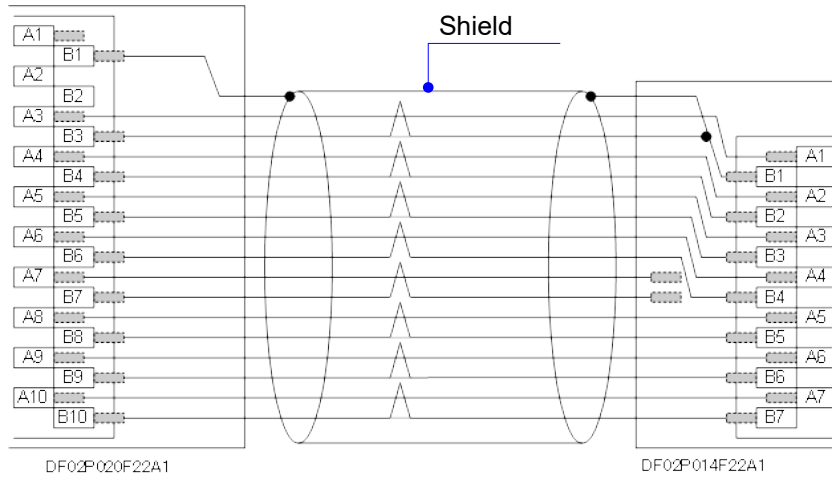

3.3 RA30-506 Cable

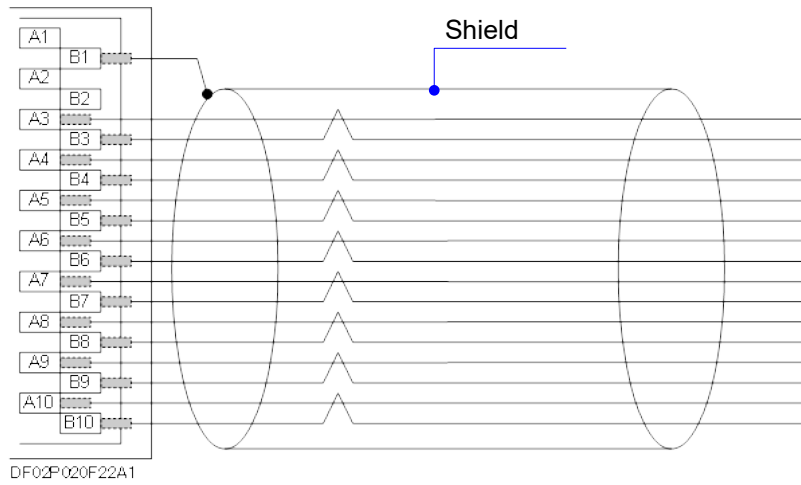

10. Appendix

This chapter provides additional explanations of various functions.

10.1. Sampling Data Format

This product has two data formats: normal sampling and P-P sampling.

10.1.1. Normal Sampling

With normal sampling, the A/D value of the sampling period is recorded as data and used for waveform reproduction and data analysis.

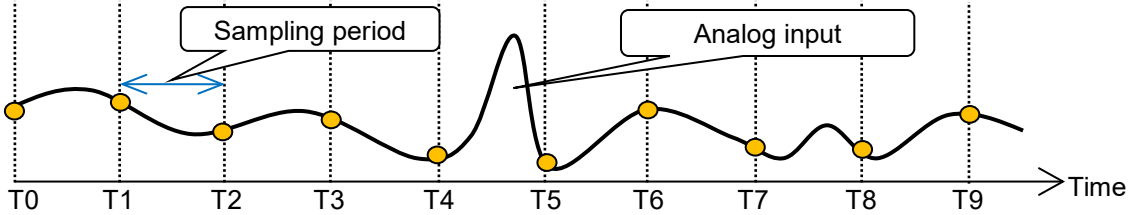

Playback the input waveform from sampling data

If the input signal is too fast for the sampling period, the waveform reproducibility may drop and lead to the unexpected loss of pulses.

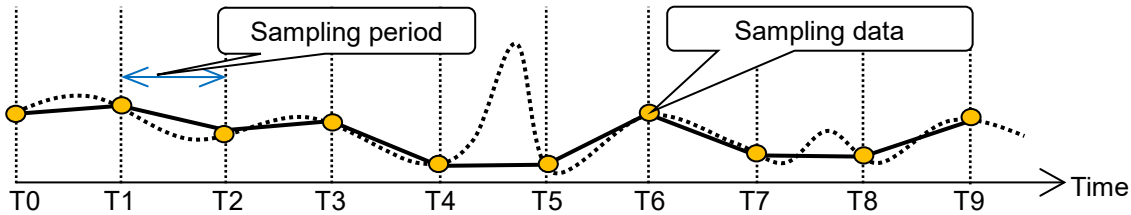

Raising the sampling speed improves the waveform reproducibility but increases the recorded data.

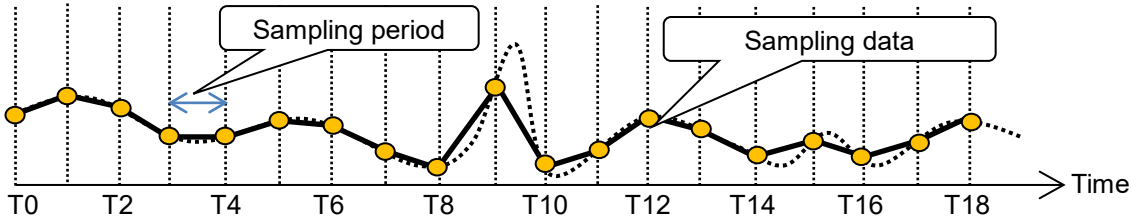

10.1.2. P-P Sampling

P-P sampling performs sampling with the data within the sampling period as the fastest sampling (20 MS/s), to detect the peak values (maximum value and minimum value) and record those peak values as the recorded data.

This data format is suitable for the waveform playback of long-term recording, as it enables waveform reproducibility of a wide band of data, without sudden spike noise, etc.

A disadvantage is that it cannot perform data analysis after recording (average, RMS, FFT, etc.)

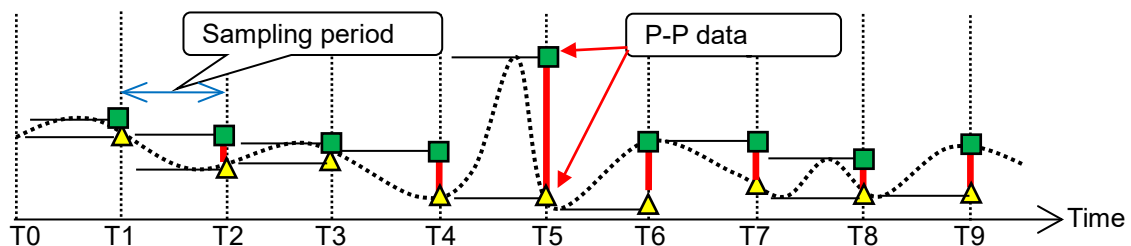

10.2. Sampling

10.2.1. Internal Sampling

The sampling speed can be set for printer recording, SSD recording, and memory recording separately. The maximum sampling speed differs for each recording. For information on specifications, see "[12.1.1 Main Unit Basic Specifications](#)".

10.2.2. External Sampling

With printer recording and SSD recording, external sampling is possible, where sampling is performed synchronized to the input of an external clock signal. However, this is only possible for printer recording or SSD recording.

The clock signal of external sampling is input to the "EXT SMPL IN" terminal of "[9.6 Remote Control Module \(RA30-112\)](#)".

10.2.3. Relationship between Sampling Speed and Chart Speed

The relationship between sampling speed and chart speed is indicated in the table below.

Sampling	Sampling speed	Chart speed
Internal	100 ms/div (1 kS/s)	100 mm/s
	200 ms/div (500 S/s)	50 mm/s
	500 ms/div (200 S/s)	20 mm/s
	1 s/div (100 S/s)	10 mm/s
	2 s/div (50 S/s)	5 mm/s
	5 s/div (20 S/s)	2 mm/s
	10 s/div (10 S/s)	1 mm/s
	20 s/div (5 S/s)	30 mm/min
	50 s/div (2 S/s)	12 mm/min
	100 s/div (1 S/s)	6 mm/min
	2 min/div (50 S/min)	5 mm/min
	5 min/div (20 S/min)	2 mm/min
10 min/div (10 S/min)	1 mm/min	
External	EXT.	0.1 mm/pulse

10.3. Scale Conversion (Physical Quantity Conversion)

The scale conversion function converts the voltage values output from a sensor, etc. to a physical quantity for direct reading.

This product has two conversion methods. Both methods perform the same conversion, as indicated in the figure.

Method 1 Direct conversion with two point values

The $Y = AX + B$ formula is derived by specifying the input and output values $[Xa, Ya]$ and $[Xb, Yb]$ of the two points a and b.

Method 2 Conversion with gain compensation when conversion between physical quantity and sensor output voltage is defined

Gain A and offset B of the sensor input are defined and the formula $Y = AX + B$ is derived.

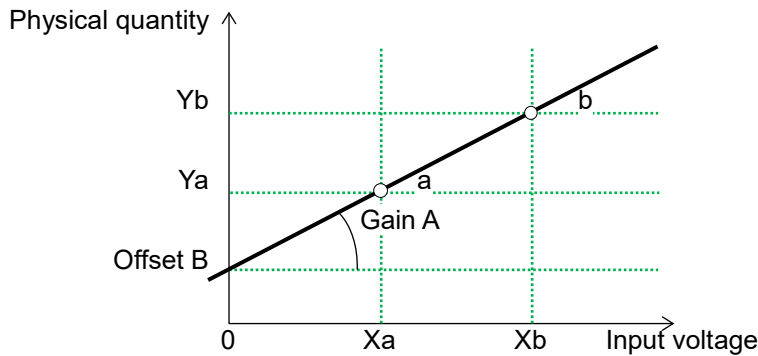

Example-1	2-pt gain 4-20mA transmission Two point method	When the sensor side output 4-20 mA (1 - 5 V) is 0 - 10 kg Conversion 1:1 → 0; Conversion 2:5 → 10 (unit: kg)
Example-2	Gain compensation Vibration sensor Sensor type	Sensitivity 4.5 N = 1 V Gain: 4.5; Offset: 0 (unit: N)

10.4. FFT Analysis

10.4.1. Analysis Function

Time Scale Waveform (One Signal Analysis)

The time domain waveform of the input signal.

Linear Spectrum (One Signal Analysis)

Each frequency component G of the linear spectrum is defined as $G = R + jI$ (with R being the real number part and I being the imaginary number part).

The frequency domain waveform of the input signal enables the amplitude and phase of each frequency component to be understood.

R and I are the result of multiplying the window function peak compensation coefficient k .

$$k = \frac{N}{\sum_{i=0}^{N-1} W(i)} \quad N: \text{Sampling points; } W(i): \text{Window function}$$

Real number part	Lin-Rel	R
Imaginary number part	Lin-Img	I
Amplitude	Lin-Amp	$\sqrt{(R^2 + I^2)}$
Logarithmic amplitude	Log-Amp	$20 \times \log\sqrt{(R^2 + I^2)}$
Phase	Phase	$\tan^{-1}(I/R)$

RMS Spectrum (One Signal Analysis)

The frequency domain waveform of the input signal enables the amplitude (effective value) and phase to be understood.

R and I are the result of multiplying the window function peak compensation coefficient k .

$$k = \frac{N}{\sum_{i=0}^{N-1} W(i)} \quad N: \text{Sampling points; } W(i): \text{Window function}$$

Real number part	Lin-Rel	$R/\sqrt{2}$
Imaginary number part	Lin-Img	$I/\sqrt{2}$
Amplitude	Lin-Amp	$\sqrt{(R^2 + I^2)}/\sqrt{2}$
Logarithmic amplitude	Log-Amp	$20 \times \log(\sqrt{(R^2 + I^2)}/\sqrt{2})$
Phase	Phase	$\tan^{-1}(I/R)$

Power Spectrum (One Signal Analysis)

Indicates the power (squared value) of the input signal to understand the amplitude information only. R and I are the result of multiplying the window function peak compensation coefficient k.

$$k = \left(\frac{N}{\sum_{i=0}^{N-1} W(i)} \right)^2 \quad N: \text{Sampling points; } W(i): \text{Window function}$$

Amplitude	Lin-Amp	$R^2 + I^2$
Logarithmic amplitude	Log-Amp	$10 \times \log(R^2 + I^2)$

Power Spectrum Density (One Signal Analysis)

Indicates the power spectrum by unit frequency Δf .

R and I are the result of multiplying the window function peak compensation coefficient k.

$$k = \left(\frac{N}{\sum_{i=0}^{N-1} W(i)} \right)^2 \quad N: \text{Sampling points; } W(i): \text{Window function}$$

Amplitude	Lin-Amp	$(R^2 + I^2)/\Delta f \times k1$
Logarithmic amplitude	Log-Amp	$10 \times \log((R^2 + I^2)/\Delta f \times k1)$

$\Delta f = F_s/N$; F_s : Sampling points; $W(i)$: Window function

k1: Window function BW compensation coefficient

Rectangular	1
Hanning	0.666
Hamming	0.731

Cross Power Spectrum (Two Signal Analysis)

The cross power spectrum derives the power between two signals. It is derived as the product of the linear spectrum G_y of the signal to compare and the complex conjugate G_x^* of the linear spectrum G_x of the base signal.

Linear spectrum of reference signal	$G_x = R_x + jI_x, \quad G_x^* = R_x - jI_x$
Linear spectrum of comparison signal	$G_y = R_y + jI_y$
Cross power spectrum	$G_{yx} = G_y \times G_x^* = (R_y + jI_y)(R_x - jI_x) = R_{yx} + jI_{yx}$
Cross power spectrum (real number part)	$R_{yx} = (R_y R_x + I_y I_x) \times k$
Cross power spectrum (imaginary number part)	$I_{yx} = (R_x I_y - R_y I_x) \times k$

R_{yx} and I_{yx} are the result of multiplying the window function peak compensation coefficient k.

$$k = \left(\frac{N}{\sum_{i=0}^{N-1} W(i)} \right)^2 \quad N: \text{Sampling points; } W(i): \text{Window function}$$

Real number part	Lin-Rel	R_{yx}
Imaginary number part	Lin-Img	I_{yx}
Amplitude	Lin-Amp	$\sqrt{(R_{yx}^2 + I_{yx}^2)}$
Logarithmic amplitude	Log-Amp	$10 \times \log(R_{yx}^2 + I_{yx}^2)$
Phase	Phase	$\tan^{-1}(I_{yx}/R_{yx})$

Transfer Function (Two Signal Analysis)

The transfer function indicates the frequency characteristics of the input and output of the transfer system.

It is derived as the ratio of the cross power spectrum G_{yx} and input (reference) power spectrum G_{xx} .

Transfer function = $H_{yx} = G_{yx} / G_{xx}$

Real number part	Lin-Rel	HR_{yx}
Imaginary number part	Lin-Img	HI_{yx}
Amplitude	Lin-Amp	$\sqrt{HR_{yx}^2 + HI_{yx}^2}$
Logarithmic amplitude	Log-Amp	$10 \times \log(HR_{yx}^2 + HI_{yx}^2)$
Phase	Phase	$\tan^{-1}(HI_{yx}/HR_{yx})$

Coherence Function (Two Signal Analysis)

Expresses a comparison of the power caused by the input signal of the transfer system and the total output power. It is derived from the cross power spectrum G_{yx} , input (reference) power spectrum G_{xx} , and output (comparison) power spectrum G_{yy} .

Amplitude	Lin-Amp	$ G_{yx} ^2 / (G_{xx} \times G_{yy})$
-----------	---------	---------------------------------------

NOTE

- The coherence function equals 1 across the entire frequency with a single measurement. Make sure to perform averaging of the frequency axis.

Octave Analysis

1/1 octave band or 1/3 octave band analysis can be performed.

This product derives the power spectrum first and then adds the data in each band range.

Amplitude	Lin-Amp	$Oct \times k1$
Logarithmic amplitude	Log-Amp	$10 \times \log(Oct \times k1)$

k1: Window function BW compensation coefficient

Rectangular	1
Hanning	0.666
Hamming	0.731

10.4.2. AVG process

Averaging is not performed when set unless valid settings are specified for the analysis function. The enabled/disabled state of averaging for different analysis settings is indicated in the table.

Analysis	Y axis		AVG method		
			Time axis	Frequency axis	Peak
Time scale waveform	Amplitude	Linear	Enabled	Disabled	Disabled
Linear spectrum	Real number part	Lin-Rel	Disabled	Disabled	Disabled
	Imaginary number part	Lin-Img	Disabled	Disabled	Disabled
	Amplitude	Lin-Amp	Disabled	Enabled	Enabled
	Logarithmic amplitude	Log-Amp	Disabled	Enabled	Enabled
	Phase	Phase	Disabled	Disabled	Disabled
RMS spectrum	Real number part	Lin-Rel	Disabled	Disabled	Disabled
	Imaginary number part	Lin-Img	Disabled	Disabled	Disabled
	Amplitude	Lin-Amp	Disabled	Enabled	Enabled
	Logarithmic amplitude	Log-Amp	Disabled	Enabled	Enabled
	Phase	Phase	Disabled	Disabled	Disabled
Power spectrum	Amplitude	Lin-Amp	Disabled	Enabled	Enabled
	Logarithmic amplitude	Log-Amp	Disabled	Enabled	Enabled
Power spectrum density	Amplitude	Lin-Amp	Disabled	Enabled	Enabled
	Logarithmic amplitude	Log-Amp	Disabled	Enabled	Enabled
Cross power spectrum	Real number part	Lin-Rel	Disabled	Disabled	Disabled
	Imaginary number part	Lin-Img	Disabled	Disabled	Disabled
	Amplitude	Lin-Amp	Disabled	Enabled	Enabled
	Logarithmic amplitude	Log-Amp	Disabled	Enabled	Enabled
	Phase	Phase	Disabled	Disabled	Disabled
Transfer function	Real number part	Lin-Rel	Disabled	Disabled	Disabled
	Imaginary number part	Lin-Img	Disabled	Disabled	Disabled
	Amplitude	Lin-Amp	Disabled	Enabled	Enabled
	Logarithmic amplitude	Log-Amp	Disabled	Enabled	Enabled
	Phase	Phase	Disabled	Disabled	Disabled
Coherence function	Amplitude	Lin-Amp	Disabled	Enabled	Disabled
1/1 octave analysis	Amplitude	Lin-Amp	Disabled	Enabled	Enabled
	Logarithmic amplitude	Log-Amp	Disabled	Enabled	Enabled
1/3 octave analysis	Amplitude	Lin-Amp	Disabled	Enabled	Enabled
	Logarithmic amplitude	Log-Amp	Disabled	Enabled	Enabled

Simple Arithmetic Average

The various elements of the analysis results are averaged using the formula indicated below.

$$S_N = (1/N) \sum_{K=1}^N Y_K$$

Exponentially Weighted Average

The averaging process for the frequency component of the analysis results, which performs averaging by exponentially weighting each element to average.

(Example) When the number of additions $N = 3$

$$E1 = Y1$$

$$E2 = (1 - \alpha) E1 + \alpha Y2$$

$$E3 = (1 - \alpha) E2 + \alpha Y3$$

α : Weighted average constant $\alpha = 1 / N$

Frequency Axis Peak Hold

Retains the maximum value of each frequency component.

10.4.3. Units of Analysis Results

The units of the analysis results are indicated below.

Analysis	X axis		Unit
Time scale waveform	Time		s
Other analysis	Frequency		Hz

Analysis	Y axis		Unit
Time scale waveform	Amplitude	Linear	eu
Linear spectrum	Real number part	Lin-Rel	eu
	Imaginary number part	Lin-Img	eu
	Amplitude	Lin-Amp	eu
	Logarithmic amplitude	Log-Amp	db
	Phase	Phase	deg
RMS spectrum	Real number part	Lin-Rel	eu
	Imaginary number part	Lin-Img	eu
	Amplitude	Lin-Amp	eu
	Logarithmic amplitude	Log-Amp	db
	Phase	Phase	deg
Power spectrum	Amplitude	Lin-Amp	eu ²
	Logarithmic amplitude	Log-Amp	db
Power spectrum density	Amplitude	Lin-Amp	eu ² /Hz
	Logarithmic amplitude	Log-Amp	db
Cross power spectrum	Real number part	Lin-Rel	eu ²
	Imaginary number part	Lin-Img	eu ²
	Amplitude	Lin-Amp	eu ²
	Logarithmic amplitude	Log-Amp	db
	Phase	Phase	deg
Transfer function	Real number part	Lin-Rel	No unit
	Imaginary number part	Lin-Img	No unit
	Amplitude	Lin-Amp	No unit
	Logarithmic amplitude	Log-Amp	db
	Phase	Phase	deg
Coherence function	Amplitude	Lin-Amp	No unit
1/1 octave analysis	Amplitude	Lin-Amp	eu
	Logarithmic amplitude	Log-Amp	db
1/3 octave analysis	Amplitude	Lin-Amp	eu
	Logarithmic amplitude	Log-Amp	db

10.5. Setup Information after Executing Initialization

The setting values after executing initialization ("8.3.1. [Maintenance](#)") are indicated below.

<Initialization>

	Item	Initialization process
1.	Waveform monitor	Recording device: PRINTER CH: All channels disabled Sampling speed: 1 s/div
2.	Input module	Common to all channels Meas.: OFF Analog input module Meas. range: Minimum filter: OFF Disp. pos.: 50% Disp. range: 100% Disp. min: -Range Disp. max: +Range Logic module, input signal: voltage V-Threshold: 1.4 V Disp. pos.: 50% Disp. range: 100%
3.	Trigger	Trigger mode: OFF By trigger source Trigger channel: OFF Analog input module Detection: UP Threshold: 0 Trigger filter: 0 μs Logic module Detection: BIT OR Bit pattern: All bits disabled Trigger filter: 0 μs
4.	Recording	Mode: Standard Data name: xxxx Automatic numbering: ON 1 Recording time: 0 d 0 h 0 min 10 s 0 ms Start time: 01/01/2000 Interval time: 0 d 0 h 0 min 0 s Printer: ON; sheet 1; real-time printing: ON SSD: ON, NORMAL Memory: ON; Block size: 2 k; Recording blocks:1 Thumbnail: No channel
5.	Sheet	SHEET1 is filled in from the youngest channel
6.	Print	Header, annotations, or footer: Clear Chart speed: All 10 min/div
7.	Environment	PC name: RA3100-01 Language: (Retained) Time zone: (Retained) Date and time: (Retained) Backlight Timer: OFF Display brightness: 10
8.	Internal clock	Retained

10.Appendix – 10.5.Setup Information after Executing Initialization

9.	Communication Setup	<p>LAN</p> <p style="padding-left: 40px;">LAN setup: Manual IP: 192.168.0.1 Subnet mask: 255.255.255.0 Default gateway: 0.0.0.0</p> <p>RS-232C</p> <p style="padding-left: 40px;">Baud rate: 9600bps Data bits: 8bit Stop bits: 1bit Parity: none Flow control: none</p>
10.	Internal SSD	All the recorded data is retained

11. Maintenance

The frame must not be removed from this product other than by our service engineers, as the product is a precision device.

This section describes the maintenance of the product.

11.1. Managing/Handling Recording Paper and Printer Recorded Data

11.1.1. Replacing Recording Paper and Monitoring Remaining Paper

Use the chart recording paper specified by A&D. Use of a chart that is not recommended may cause failure in printing or shorten the life of the thermal head.

Red is printed on the recording paper when the recording paper is running low. The remaining paper monitor (PAPER) is displayed on the [side menu](#) of the monitor. Follow these to replace the recording paper.

For information on the replacement method, see "2.1.3. [Paper Loading](#)".

Remaining Paper Monitor Operations

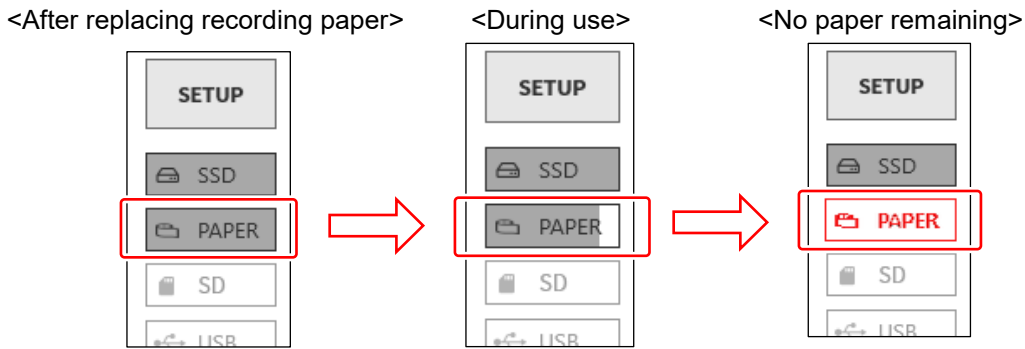

Reset the remaining paper monitor after replacing the recording paper. Press and hold **【 PAPER 】** (remaining paper monitor) on the [side menu](#) to display the dialog box for resetting.

Tap **【 Reset to 30 m 】** for a 30 m paper roll (YPS-106 or YPS-108) or **【 Reset to 200 m 】** for a 200 m Z-fold paper (YPS-112), and then tap **【 CLOSE 】**.

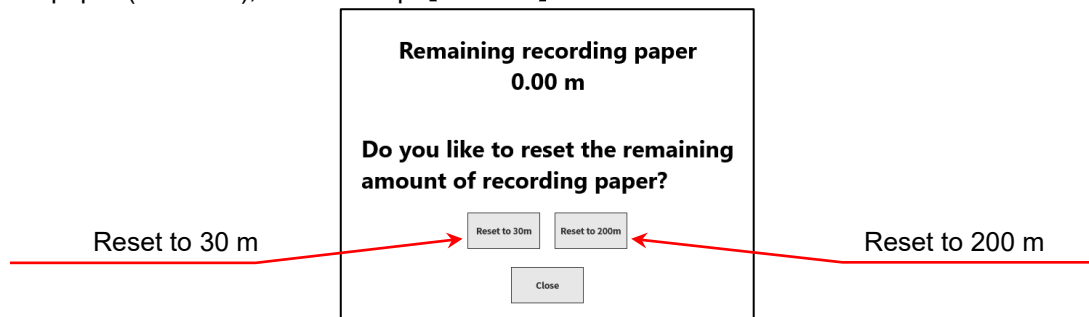

11.1.2. Storing Recording Paper

Storing Recording Paper before Recording

- Avoid storing recording paper in high temperature or high humidity environments. Take care as storing it in a high temperature environment for an extended period of time will cause the white background to change color.
- When storing recording paper, remove it from the main unit and insert it in a plastic bag, or as-is if it is still in its original packaging, and then store it in a dark location with a temperature of 25°C or less and humidity of 70% RH or less.
- Do not expose it to sunlight for extended periods of time. Take care when performing measurement or storage outdoors, as exposing it to light for an extended period of time will cause the white background to change color.

Storing Recorded Data

- Avoid storing recorded data in high temperature or high humidity environments or exposing it to sunlight or strong light for an extended period of time, as it may lose color or the white background may change color.
- When storing recording paper for an extended period of time after recording, file it in a dark location with a temperature of 25°C or less and humidity of 70% RH or less. When using a file folder, make sure that it is made of a material that does not include plasticizer (such as polyethylene or polypropylene).
- If the recording paper touches the following materials or products, the printing surface may change color, lose color, or exhibit otherwise poor color performance.
Vinyl chloride products, organic compounds, adhesive tape, pencil eraser, rubber mats, magic markers, felt-tip pens, correction fluid, carbon, diazo photosensitive paper, hand cream, hairdressing products, cosmetic products, or leather products such as a wallet
- Recorded data that has colored cannot be removed by rubbing or wetting it. However, do not rub the recorded data part, as rubbing the recording paper strongly will cause it to color due to the frictional heat.

11.1.3. Printer Block Errors

The state of the following three items is monitored for the printer block to control recording. If an error occurs during recording, the error is displayed on the monitor and recording ends.

- Existence of recording paper
- Printer cover lock state
- Thermal head temperature

NOTE

- The thermal head temperature may be high after performing printer recording for an extended period of time, which can cause an error. Take the installation location, printing density, and recording speed into consideration so that no error occurs.

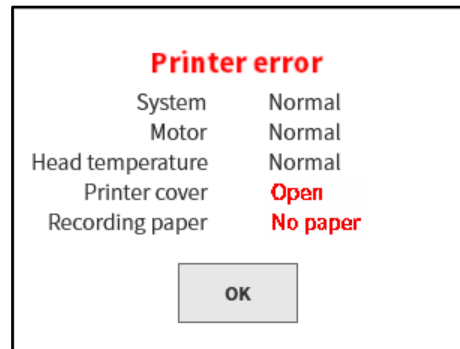

Printer error dialog box

11.2. Backing Up Recorded Data

This product records measured data on the internal SSD. Make sure to periodically perform maintenance (data backup or deletion) on the SSD, because failing to do so may prevent measurement from being performed due to insufficient space.

The SSD remaining capacity monitor (SSD) is displayed on the [side menu](#) of the monitor, and maintenance can be performed based on that display.

For information on backing up recorded data and deleting it from the SSD, see "8. 2. 1. [Record management](#)".

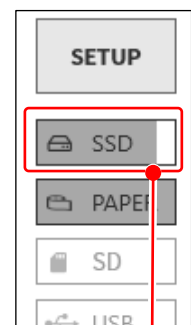

<SSD remaining capacity monitor>

Displays the remaining capacity of the internal SSD in the indicator.

Maintenance procedure

- Step 1. Copy the recorded data to back up to external media using the export function.
- Step 2. Delete unnecessary recorded data.

11.2.1. Internal SSD Errors

The life of the internal SSD of the recording device greatly varies according to the number of times data has been overwritten. The health of the SSD can be checked in [Remaining life] and [Health] in 【SSD】 on the [Maintenance] screen. When the life remaining is close to 0%, please contact our sales representative to replace the SSD.

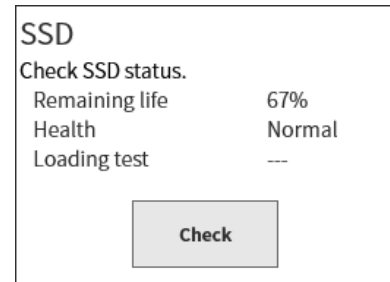

11.3. Display Cleaning

When the surface of the display is dirty, wipe it clean with a soft, dry cloth or gauze dampened with ethanol.

11.4. Thermal Head Cleaning/Life

11.4.1. Cleaning

When recording has been performed for an extended period of time, material such as dust or printing waste may adhere to the thermal head thermocouple. This may cause printing to become unclear and reduce the image quality. In this case, follow the procedure below to clean the thermal head.

- Step 1. Open the printer cover by pulling the lever of the printer block up.
- Step 2. The thermal head can be seen in the top inside of the printer block. The thermocouple is at a line 4.4 mm from the thermal head edge. Clean that line area.
- Step 3. Gently wipe it clean with a cotton bud or gauze dampened with ethanol. The recording paper colors when exposed to ethanol, so it is recommended that you remove it from the stock area before cleaning.
- Step 4. Load the recording paper after the thermal head dries.

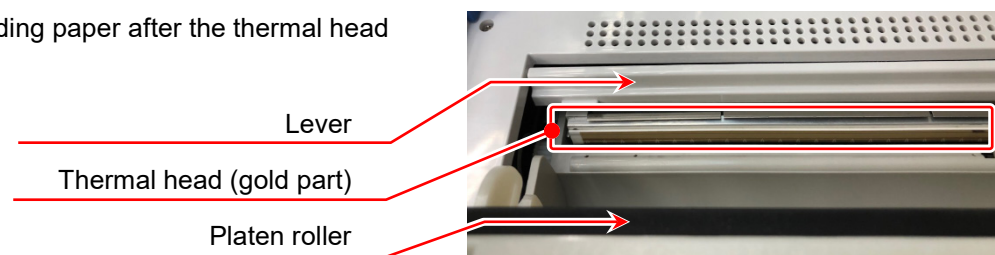

11.4.2. Life

The wear resistance of the thermal head is about 30 km (approximately 1,000 rolls of YPS106 recording paper) or about 30 million printing pulses. Recording quality may not be able to be maintained after that. In this case, please contact our sales representative to replace the thermal head (at an extra cost).

11.5. Platen Roller Maintenance

Foreign material or dust adhering to the platen roller may cause damage to the thermal head or may cause printing to become unclear and reduce the image quality. In this case, gently wipe the platen roller clean using gauze dampened with ethanol.

11.6. Power Outages

If a power outage occurs or the power cable becomes disconnected during recording, the internal SSD may become damaged and unable to be accessed. An UPS (uninterruptible power supply) is recommended to be used.

11.7. Battery Replacement

The life of the backup battery for the internal clock is about 10 years (at 23°C). If the clock resets every time the power is turned on, the battery may need to be replaced.

In this case, please contact our sales representative.

11.8. Fan Replacement

If the internal fan stops due to failure, the internal temperature of the product will rise and may cause damage to other devices inside the product. The state of the fan can be checked in **【 Fan 】** on the [Maintenance] screen.

If an error occurs, please contact our sales representative for a repair.

11.9. Cautions for Disposing This Product

Take care of the following when disposing of this product.

WARNING

- This product includes a coin lithium battery (primary cell) for backup purposes.
- When disposing of this product, make sure to remove the battery.
- Do not dispose of the battery in fire or disassemble.
- The battery may explode when it is heated and organic electrolyte that may exude from it is harmful to human skin.
- When disposing of the battery, isolate the terminals by covering with tape and dispose the battery as a dangerous article.
- This product uses a liquid crystal display.
The disposal of liquid crystal displays may be regulated by local government.
Follow the local regulations when disposing of it.

11.10. Troubleshooting and Inspection

If this product does not operate normally after performing the indicated countermeasure or a repair is required, please contact our sales representative.

Symptom	Possible cause	Countermeasure
The power does not turn on. Nothing is displayed on the screen.	The power cord is not connected to the connector properly.	Connect the power cord properly and turn on the power switch
	The fuse has blown.	The fuse for this product cannot be replaced by the customer because it is located inside the main unit. Please contact our sales representative if the fuse may be blown.
	The screen is set to turn off automatically.	Press any key to turn on the screen.
The touch panel or keys do not respond.	The product is recording. The start LED is on.	Perform the operation again after pressing stop on the operation panel to stop measurement.
	The key lock is enabled.	Turn off the side touch panel lock.
Printer recording is not performed.	There is no recording paper.	Load recording paper.
	The printer cover is open.	Close the printer cover.
	The thermal head is at an abnormally high temperature.	Use the product in a location at a temperature between 0 and 40°C. Do not continuously print solid black areas.
	Real-time waveform printing is disabled in the recording settings.	Enable real-time waveform printing in the recording settings and start recording.
SSD recording is not performed.	There is no free space remaining on the SSD.	Delete unnecessary recorded data.
Memory recording cannot be replayed.	Memory data is not saved because the trigger is not enabled.	Cause a manual trigger using the TRIG key on the operation panel.
Recording does not start when the START key is pressed.	The recording mode is set to trigger start or time start.	Disable the START trigger.
	External sampling recording is enabled.	Press the start key after inputting the signal, as recording cannot start unless a pulse signal is input to the remote terminal.
	Recording paper has not been loaded.	Load recording paper.
	The key lock is enabled.	Disable the side key lock.
Data cannot be saved to the specified media.	The media has not been formatted.	Format the media.
	There is insufficient free space on the media.	Delete unnecessary files or use new media.
	The media is set to read-only.	Disable the read-only setting of the media.
The media is not recognized.	The format of the media is invalid.	Format the media.
	The media is damaged.	Use other media.
The communication interface cannot be used to configure settings and control operation.	The communication parameter settings do not match.	Match the address and communication parameters.

12. Specifications

12.1. General Specifications

12.1.1. Main Unit Basic Specifications

Item	Specifications	
Input block	Number of module slots	9 slots
	Analog input	Maximum 36 channels
	Logic input	Maximum 144 channels
Recording device	Internal SSD	256 GB
	Internal memory	4 GB
	Internal printer	216 mm thermal printer
Recording function	SSD recording	Directly recording to internal SSD
	Memory recording	Recording high-speed phenomena to memory
	Printer recording	Directly recording input signals to printer
Sampling speed	SSD recording	1 MS/s to 10 S/min
	Memory recording	20 MS/s to 10 S/min
	Printer recording	1 kS/s (100 mm/s) to 10 S/min (1 mm/min)
Sampling accuracy	±10 ppm (max)	At all available temperature ranges
Printer block	Thermal printer	
	Recording width	216 mm
	Recording speed	100 mm/s to 1 mm/min 1, 2, 5 series
	Chart speed accuracy	Within ±2 % (25 °C, 65 % RH)
	Recording paper	219 mm x 30 m Paper roll (YPS-106, YPS-108) 219 mm x 200 m Z-fold paper (YPS-112)
Display block	12.1" XGA TFT color LCD (1024 x 768 dots)	
	With electrostatic capacitive touch panel (supporting two point multi-touch)	
Operation panel	Operation panel key	POWER Power on/off
		START Start recording
		STOP Stop recording
		TRIG Forced trigger
		PRINT Start printer recording/screen copy
Lock function	Rotary knob	Change measurement range or waveform position, etc.
	Key lock	Operation panel key lock
	Screen lock	Touch panel key lock
Interfaces	LAN, USB, SD, COM, DVI-D For details, see " 12.2.10. Interface Specifications ".	

12.1.2. General Specifications

Item	Specifications	
Power	Rated power voltage	AC 100 to 240 V
	Allowed range of variation in power voltage	AC 90 to 264 V
	Rated power frequency	50/60 Hz
	Allowed range of variation in power frequency	47 to 63 Hz
	Withstand voltage	Between power and case 1500 V AC for 1 minute
	Insulation resistance	Between power and case 100 MΩ or more at 500 VDC
	Power consumption	For printer recording 300 VA (maximum printing state) When recording is stopped 80 VA For standby 5 VA (power cord connected and power off)
	Power fuse	Internal (not replaceable)
Locations for use	Indoor, Pollution Degree 2 *1, elevation 2000 m or lower	
Warmup time	60 minutes or longer	
Operating environment	Temperature	0 to 40°C
	Humidity	35 to 85 RH% (without condensation)
Storage environment	Temperature	-20 to 60°C
	Humidity	20 to 85 RH% (without condensation)
Vibration resistance	Sine wave vibration	
	Vibration frequency	10 to 55 Hz
	Vibration level	20.0 m/s ² , 3 axis, 20 cycles each
	Random vibration	
	Vibration frequency	5 to 500 Hz
	Acceleration rms value	X, Y axis 6.5 m/s ² , Z axis 10.2 m/s ² , 1 hour each
Backup battery life	Approx. 10 years (ambient temperature 23°C), for clock backup	
Standards	Safety standards	EN61010-1 Overvoltage Category II (CAT II) *2 EN61010-2-30 Measurement Category *3
		Dependent on specifications of installed modules
	EMC	EN61326-1 Class A
Dimensions	Approx. 394 mm (W) x 334 mm (H) x 199 mm (D) *Excluding protrusions	
Mass	9.5 kg or less (main unit only)	
Warranty period	1 year	

*1 The Pollution Degree indicates the level of pollution that can exist in the ambient environment.

Pollution degree 1: No pollution or only dry, non-conductive pollution occurs. The pollution has no influence.

Pollution degree 2: Only non-conductive pollution occurs except that occasionally a temporary conductivity caused by condensation is to be expected.

Pollution degree 3: Conductive pollution occurs, or dry, non-conductive pollution occurs which becomes conductive due to condensation which is to be expected.

Pollution degree 4: The pollution generates persistent conductivity caused by conductive dust or by rain or snow.

- *2 The Overvoltage Category (Installation Category) indicates how much overvoltage (impulse voltage) from an AC power supply an electrical device can withstand. Overvoltage Category II (CAT II) is suitable for devices powered by wire from the switchboard of a building.
- *3 The Measurement Category categorizes a testing or measurement circuit according to the type of main power circuit intended to be connected for testing or measurement, and differs according to the modules installed to this product. Use the product within the Measurement Category that meets the module specifications.

CAT II: Applies to testing and measurement circuits directly connected to the point of use (power outlet or similar location) of a low voltage main power supply system.

CAT III: Applies to testing and measurement circuits connected to the switchboard of the low voltage main power supply system in a building.

CAT IV: Applies to testing and measurement circuits connected to the source of the low voltage main power supply system in a building.

No category (O): Applies to circuits not directly connected to a main power supply.

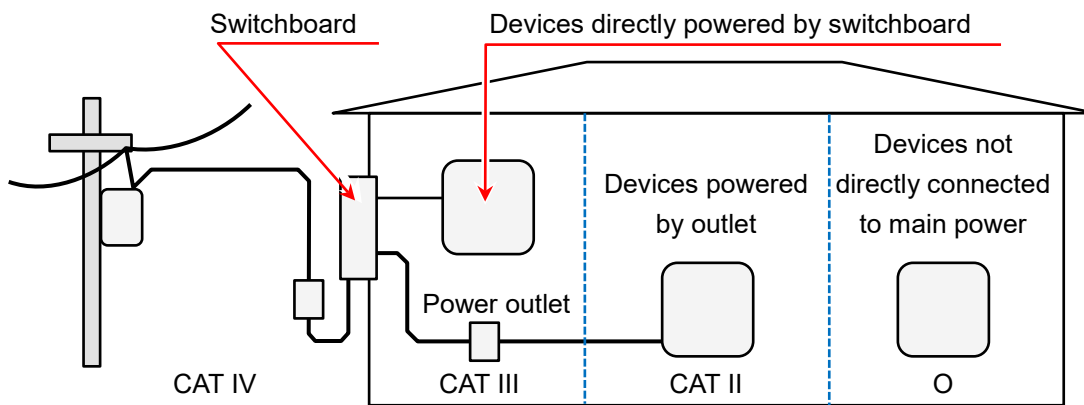

- O : Other circuits not directly connected to main power
- CAT II : Measurement Category II
- CAT III : Measurement Category III
- CAT IV : Measurement Category IV

12.2. Functional Specifications

12.2.1. Measurement Function

Item	Specifications	
Mode	The recording modes are indicated below.	
	(1) Standard	
	(2) Start time	
	(3) Start trigger	
	(4) Interval (N times)	
	(5) Start time + Start trigger	
	(6) Start trigger + Interval (N times)	
	(7) Start time + Interval (N times)	
	(8) Start time + Start trigger + Interval (N times)	
(9) Window recording		
Recording device	Recording to SSD, memory, or printer, and recording to various recording devices at the same time	
Display format	Y-T waveform	Y-T waveform with amplitude on vertical axis and time on horizontal axis
	X-Y waveform	Up to four sets of X-Y waveforms with a user-defined analog input channel specified for the X axis (horizontal) and Y axis (vertical).
	FFT waveform	FFT analysis waveform with maximum two channels
	Digital data	Displays data with numeric values
Sampling speed	Differs according to recording device.	
Maximum recording time	100 days	

12.2.2. SSD Recording

Item	Specifications	
Function	Records input data directly to the internal SSD.	
Recording device	Internal SSD 256 GB	
Number of channels	Analog 36 ch (max)	
	Logic 144 ch (max)	
Data format	NORMAL data	Samples and records data at the set sampling speed. Records the two peak values (max/min) of the data within the set sampling speed period sampled at 20 MS/s.
	P-P data	
Sampling speed	1 MS/s to 10 S/min	500 kS/s (max) for P-P data The speed can be set to 1, 2, or 5 series
	External sampling*1	Synchronization clock: 250 kHz or less
Information data	Records information related to the recorded data, such as the version of the product, module configuration, channel settings, data format, and recording time.	
Recorded data	Records input data, memory recording start data, and event data (trigger information, marks).	
Window recording	Records the last data specified at the recording time when recording stops. Cannot be used in conjunction with memory recording or printer recording.	
Playback processing	Y-T waveform	Display position changes via swiping and pinch in/pinch out operations to enlarge/reduce.
	FFT Analysis	When the recorded data is NORMAL, FFT analysis function processing is possible.
	X-Y Waveform	When the recorded data is NORMAL, X-Y processing is possible, sampling 1 kS/s or below.

*1 Available when the optional remote control module is installed.

12.2.3. Memory Recording

Item	Specifications	
Function	Records to the internal memory with high-speed sampling.	
Recording device	Internal memory	2 GW*1
	Record blocks (number of memory divisions)	Divided into 1 to 200 user-defined blocks
Recording device	Points	The number of data items per channel that can be recorded to a recording block 2 kW to 2 GW (selected in step 1-2-5)
	Channels x points x blocks ≤ 2 GW	
	Number of channels	Analog 36 ch (max), 18 ch at 20 MS/s Logic 144 ch (max)
Data format	NORMAL data	
Sampling speed	20 MS/s to 10 S/min	The speed can be set to 1, 2, or 5 series
Information data	Records information related to the recorded data, such as the version of the product, module configuration, channel settings, data format, and recording time.	
Recorded data	Records input data and trigger information.	
Playback processing	Y-T waveform	Display position changes via swiping and pinch in/pinch out operations to enlarge/reduce.

*1 W (word) refers to a unit of data. 1 W = 2 bytes

12.2.4. Printer Recording

Item	Specifications		
Function	Directly records the input signal to the printer as a waveform.		
Recording drive	Internal printer	Thermal printer	
Number of printer recording channels	144 ch	The total analog and logical channels that can record to the SSD simultaneously	
	48 ch	The total number of analog and logical channels that can record to recording paper simultaneously, channel for printing to recording paper can be selected with sheet settings, and all channels can be printed with the playback function	
Data format	P-P data		
Recording speed	100 mm/s to 1 mm/min	1, 2, or 5 series,	
External sampling*1	50 mm/s (500 Hz) max for external sampling		
Recording resolution	Waveform amplitude direction	8 dots/mm	
	Time axis direction	100 S/div	
	Printing resolution	20 dots/mm	100 mm/s
		40 dots/mm	50 mm/s, external sampling*1
	80 dots/mm	25 mm/s or less	

*1 Available when the optional remote control module is installed.

12.2.5. Trigger Function

[Basic trigger function]

Item	Specifications
Trigger function	Start trigger Memory trigger
	Start trigger for recording operation Trigger for memory recording
	Analog input signal*2
	Level trigger
	Window trigger
Trigger type	Trigger when an analog signal transects (rises above/falls below) the set threshold INTO WIN: Trigger when the analog signal enters the upper/lower limit range OUT WIN: Trigger when the analog signal leaves the upper/lower limit range
	Logic input signal*2
	Bit pattern trigger
	Forced trigger
	External trigger*1
	Logic signal bit pattern judgment trigger When the trigger key of the operation panel is pressed When the external trigger input signal becomes active*1
Trigger filter	This function generates a trigger if the trigger conditions continue to be established for the specified period of time (to ensure that a trigger is not generated by noise, etc.)
	Filter time 0 to 100 s

*1 Available when the optional remote control module is installed.

*2 Analog input and logical input triggers (triggers from input channels) are collectively referred to as channel triggers.

[Start trigger]

Item	Specifications
Trigger source	Channel trigger, forced trigger, external trigger
Channel trigger specified number of channels	1 ch

[Memory trigger]

Item	Specifications
Trigger source	Channel trigger, forced trigger, external trigger
Channel trigger specified number of channels	18 channel AND/OR setting available

12.2.6. Waveform Monitor Function

Item	Specifications	
Display screen	MEASURE	Displays the state waveform of the input signal
	PLAYBACK	Playback the memory, SSD, or printer recorded data
Waveform type	Y-T waveform, X-Y waveform, FFT waveform	
	Enables waveform display for an arbitrary analog signal and logic signal	
	Y-T waveform	Enables 48 channel/sheet signal display
	X-Y waveform	Enables a maximum of four X-Y waveform sets to be displayed
Y-T waveform display	FFT waveform	Enables FFT analysis results to be displayed for a maximum of two channels
Display width	20 div x 20 div	1 div = 100 samples
	Time axis (T axis)	1 div = 1/10 RANGE (with display range at 100%)
	Amplitude axis (Y axis) Display area	Specifies the display position, display range, display maximum, and display minimum
Sheet	Enables waveform screens to be managed as three waveform screens (display channel sets)	
Number of graphs	1 to 18	
Display functions	Numeric value display	Numeric value display of input signal
	Scale	Scale display of amplitude axis
	Grid	Grid display of waveform area
	Trigger/mark	Displays detected trigger/mark
	Cursor	Displays two cursors
	Displays the signal information (position and value) of the cursors, information on the differences between cursors, maximums, minimums, and averages	
	Pen position	Displays the signal amplitude position
	Zero position	Displays the signal zero position
	Time display	Displays the time on the bottom of the display area
Pinch in/out	Enlarges/reduces the display waveform	
TRIG.SYNC	Updates the waveform display screen when the trigger conditions are established	

12.2.7. X-Y Waveform

Item	Specifications
Data selection	SSD recorded data Data format: Normal data
X-Y axis	X axis channel: User-defined analog channel
	Y axis channel: User-defined analog channel Four waveforms can be set
Sampling speed	1 kS/s (max)
Display format	Select single screen or quad screen
	Single Displays four sets of X-Y waveforms on a single screen Quad Displays a separate X-Y waveform on each of four screens
Pen up	Pauses measurement The pen up operation can be performed for one waveform at a time or all waveforms at once
Pen down	Resumes measurement The pen down operation can be performed for one waveform at a time or all waveforms at once
Clear	Clears the displayed waveform The clear operation can be performed for one waveform at a time or all waveforms at once
Refresh graph	Redraws the X-Y waveform between cursors A and B on the Y-T waveform.
Display functions	Dot/line Renders the X-Y waveform with dots or lines
	Scale Input signal scale display of X axis and Y axis
	Grid Grid display of waveform area
	Pen position Displays the input signal position
	Zero position Displays the signal zero position Pinch in/out Enlarges/reduces the waveform

12.2.8. FFT Analysis

Item	Specifications
Data selection	SSD recorded data Data format: Normal data
Sampling points	Set the analysis sampling points: Select 1000, 2000, 5000, or 10000 points
Frequency range	500 kHz (max), the frequency range is calculated as 0.5 x the sampling speed
Analysis range selection	Selects the analysis range using two cursors.
Window function	Supports amplitude gain using a window function. Hanning, hamming, rectangular
Analysis function	Time scale waveform, linear spectrum, RMS spectrum, power spectrum, power spectrum density, 1/1 octave analysis, 1/3 octave analysis, cross power spectrum, transfer function, coherence function
Analysis count	2
Display format	Single/Dual
X axis scale	Time, linear frequency, log frequency, 1/1 octave, 1/3 octave
Y axis scale	Amplitude, linear real part, linear imaginary part, linear amplitude, log amplitude, phase
Manual scale	Manually sets the X axis and Y axis display area
Averaging	Time simple averaging, frequency simple averaging, frequency exponential weight averaging, frequency axis peak hold, None
Average number of additions	1 to 10
Peak value display	Identifies a maximum of 10 local maximums or global maximums from the analysis results.
Cursor	Displays two cursors for each analysis and displays the X value and Y value of each cursor.
Pinch in/out	Enlarges/reduces the FFT analysis results with pinch in/pinch out operations.

12.2.9. Setup/Record management

Item	Specifications
Recording Setup	<p>Mode: Nine type recording mode display and selection.</p> <p>Data name: Data name, automatic numbering.</p> <p>Recording time: Recording time setting for one time, maximum time settable from remaining SSD capacity</p> <p>Start time: Set the recording start time</p> <p>Interval time: Set the Interval time and number of recordings</p>
Recording	<p>Printer: Enable/disable printer recording when performing measurement, sheet selection, enable/disable real-time waveform printing during measurement.</p> <p>SSD: Enable/disable SSD recording when performing measurement.</p> <p>Memory: Enable/disable memory recording when performing measurement, record blocks, points, endless mode, pre-trigger settings.</p> <p>Thumbnails: Sets the channels to displayed in the thumbnails on the monitor and the compression ratio for the display from 1/10 to 1/100.</p>
Channel List	<p>Common: Displays and configures a list of common settings set in modules and the input module installed in this product. Display items: Channel number, module type. Display items and settings: CH name, measurement, sheet, color, display position, display range, display maximum, and display minimum.</p> <p>Conversion: List of physical conversion for the installed analog input module. Display items and settings: Conversion method (2-pt /gain), conversion value (conversion 1, conversion 2), unit.</p> <p>List by input module type: Displays and configures a list of the settings unique to each module. Each item can be configured individually or together.</p>
Sheet	List of registered channels and channel registration to sheets 1 to 3
Printer	<p>Printing: Print settings for the header, annotation, footer, grid, date, data name, time axis, and recording speed printed at the same time as the printer printing</p> <p>Text settings: Inputs and imports/exports text for printing headers, annotations, and footers 60 characters for the text (in the paper feed direction) x 86 lines (waveform amplitude direction)</p> <p>Chart speed: Sets a user-defined chart speed. Six speed settings can be set.</p>
Record management	<p>List of recorded data: Displays a list of the data recorded to this product.</p> <p>Choice: Selects data in the list. Multiple data can be selected.</p> <p>Select all: Selects all the recorded data in the list.</p> <p>Release all: Deselects all the data in the list.</p> <p>Delete: Deletes the selected recorded data.</p> <p>Import: Reads recorded data saved on USB memory or an SD memory card.</p> <p>Export: Writes recorded data to USB memory or an SD memory card.</p> <p>Restore recording setup: Reads settings information from the selected recorded data and sets it in the main unit.</p>

Item	Specifications	
Image Management	Image list	Displays a list of the images recorded to this product.
	Choice	Selects images in the list. Multiple data can be selected.
	Select all	Selects all the recorded data in the list.
	Release all	Deselects all the data in the list.
	Delete	Deletes the selected images.
	Print	Prints the selected images from the printer.
	Export	Outputs the selected images to USB memory or an SD memory card.
Environment	PC name	Sets the name of the main unit using 15 characters or less. This name is used for identification purposes on the network and in recorded data.
	Language	English
	Time zone	Sets the time zone (regional standard time).
	Date and time	Sets the current date and time.
	Backlight timer	Backlight timer automatic disable setting Select [OFF], [1 minute], [5 minutes], [10 minutes], [30 minutes], or [60 minutes] The backlight of the LCD display automatically turns off at the set time.
	Display brightness	Sets the brightness of the LCD display.
Display	Grid	Switches the grid lines of the waveform screen on or off.
	Trigger line	Switches the trigger lines of the waveform screen on or off.
	Mark line	Switches the mark lines of the waveform screen on or off.

12.2.10. Interface Specifications

Item	Specifications	
LAN	Supported standard	IEEE802.3 (1000BASE-T, 100BASE-TX, 10BASE-T)
	connectors	RJ-45
	Number of ports	1
USB	Supported standard	USB3.0
	connectors	Type-A
	Number of ports	2
SD	Supported standard	SD standard (SD/SDHC/SDXC supported)
	connectors	Slot for SD memory cards
	Number of ports	1
COM	Supported standard	EIA-574
	connectors	D-Sub9
	Number of ports	1
DVI-D	Supported standard	DVI-D (dual link not supported)
	connectors	DVI-D
	Number of ports	1

12.2.11. Communication Setup

Item	Specifications	
Network	IP address setup	Select to automatically retrieve or manually set the IP address. When manually setting the IP address, the IP address, subnet mask, and default gateway can be manually set.
	IP address	Set the IP address.
	Subnet mask	Set the subnet mask.
	Default gateway	Set the default gateway.
	DNS server address setup	Select to automatically retrieve or manually set the DNS server. When manually setting the DNS server the preferred DNS server and alternate DNS server can be set.
	Preferred DNS server	Set the preferred DNS server.
	Alternate DNS server	Set the alternate DNS server.
RS-232C	Baud rate	Select the RS-232C baud rate. 300 to 460800 bps
	Data bits	The RS-232C data bit length, fixed to 8 bits
	Stop bits	Select the RS-232C stop bits. Select 1 or 2 bits.
	Parity	Select the RS-232C parity. None, odd, even, mark, or space
	Flow control	Select the RS-232C flow control method. None, XON/XOFF, or hardware (CTS/RTS).

12.2.12. Other Setup (Maintenance/Operation History/Version Management)

Item	Specifications
SSD check	SSD life remaining, health check, and loading test
Fan check	Displays the state of the internal cooling fan
LCD check	LCD screen check and pixel defect check
Brightness check	LCD back light brightness control check
Printer	Prints a test patten from the printer Printer state check: System, motor, head temperature, printer cover, recording paper
Buzzer	Controls the buzzer on/off to check the buzzer
Panel keys	Press the panel keys to check whether they operate normally
Panel key LED	Turns the panel LEDs on/off to check whether they operate normally
Initialize	Returns the settings of this product to the factory defaults.
Operation history display	Displays the history of the past 100 operations.
Version management	Displays the serial number and version of this product and the version information of each module

12.3. Module Specifications

12.3.1. Two Channel Voltage Module (RA30-101)

Item	Specifications	
Number of input channels	2 ch	
Input connectors	Insulated BNC	
Input format	Unbalanced input (insulation between channels and between channels and chassis)	
Coupling	AC/DC/GND	
Input impedance	1 M Ω \pm 1%	
Measurement range (RANGE)	100, 200, 500 mV 1, 2, 5, 10, 20, 50, 100, 200, 500 V (the measurement range is \pm RANGE)	
Measurement probability	\pm 0.3% of RANGE (23°C \pm 5°C, DC coupling, L.P.F. 3 Hz, after zero adjust)	
Temperature coefficient	\pm (400 ppm of RANGE)/°C (input conversion at 0.1 V RANGE)	
Frequency characteristics	DC coupling	DC to 100 kHz (-3 dB to 1 dB) (with L.P.F. and A.A.F. disabled)
	AC coupling	0.3 Hz to 100 kHz (-3 dB to 1 dB) (with L.P.F. and A.A.F. disabled)
Low-pass filter (L.P.F.)	Cutoff frequency	3 Hz, 30 Hz, 300 Hz, 3 kHz, OFF (-1.6 dB \pm 1 dB)
	Characteristics	Secondary Bessel
Anti-aliasing filter (A.A.F.)	Cutoff frequency	20, 40, 80, 200, 400, 800, 2k, 4k, 8k, 20k, 40 kHz, OFF, with 0.4 times the sampling speed of SSD recording set for the cutoff frequency. When 200 kS/s or higher, A.A.F. is disabled.
	Attenuation	-66 dB or less at 1.5 times the cutoff frequency
Input conversion noise	1 mVp-p max (0.1 V range, input short circuit)	
A/D conversion	A/D resolution	16 bits
	Sampling rate	1 MS/s (max)
Common mode rejection ratio	80 dB or higher (50/60 Hz)	
Maximum allowed input voltage	\pm 500 V peak	
Maximum rated voltage to ground	AC, DC 300 V CAT II (between input terminals and chassis, between channels)	
Withstand voltage	AC 3 kV, 1 minute (between input terminals and chassis, between channels)	
Usage environment	Temperature: 0 to +40°C, humidity: 35 to 85 RH% or less (without condensation)	
Storage environment	Temperature: -20 to +60°C, humidity: 20 to 85 RH% or less (without condensation)	
Dimensions	Approx. 140 mm (W) x 223 mm (H) x 20 mm (D)	
Mass	Approx. 300 g	
Standards	Safety	EN61010-1, EN61010-2-30 Measurement category CAT II, pollution level 2
	EMC	EN61326-1, class A (when mounted to RA3100 main unit)

12.3.2. Four Channel Voltage Module (RA30-102)

Item	Specifications	
Number of input channels	4 ch	
Input connectors	Insulated BNC	
Input format	Unbalanced input (insulation between channels and between channels and chassis)	
Coupling	DC/GND	
Input impedance	1 M Ω \pm 1%	
Measurement range (RANGE)	1, 2, 5, 10, 20, 50, 100, 200 V (the measurement range is \pm RANGE)	
Measurement probability	\pm 0.2% of RANGE (23°C \pm 5°C, DC coupling, L.P.F. 3 Hz, after zero adjust)	
Temperature coefficient	\pm (400 ppm of RANGE)/°C (input conversion at 1 V RANGE)	
Frequency characteristics	DC coupling	DC to 100 kHz (-3 dB to 1 dB) (with L.P.F. disabled)
Low-pass filter (L.P.F.)	Cutoff frequency Characteristics	3 Hz, 30 Hz, 300 Hz, 3 kHz, OFF (-1.6 dB \pm 1 dB) Secondary bessell shape
Input conversion noise	5 mVp-p max (1 V range, input short circuit)	
A/D conversion	A/D resolution Sampling rate	16 bits 1 MS/s (max)
Common mode rejection ratio	80 dB or higher (50/60 Hz)	
Maximum allowed input voltage	\pm 200 V peak	
Maximum rated voltage to ground	AC, DC 300 V CAT II (between input terminals and chassis, between channels)	
Withstand voltage	AC 3 kV, 1 minute (between input terminals and chassis, between channels)	
Usage environment	Temperature: 0 to +40°C, humidity: 35 to 85 RH% or less (without condensation)	
Storage environment	Temperature: -20 to +60°C, humidity: 20 to 85 RH% or less (without condensation)	
Dimensions	Approx. 140 mm (W) x 223 mm (H) x 20 mm (D)	
Mass	Approx. 320 g	
Standards	Safety	EN61010-1, EN61010-2-30 Measurement category CAT II, pollution level 2
	EMC	EN61326-1, class A

12.3.3. Two Channel High-Speed Voltage Module (RA30-103)

Item	Specifications	
Number of input channels	2 ch	
Input connectors	Insulated BNC	
Input format	Unbalanced input (insulation between channels and between channels and chassis)	
Coupling	AC/DC/GND	
Input impedance	1 MΩ ±1%	
Measurement range (RANGE)	100, 200, 500 mV 1, 2, 5, 10, 20, 50, 100, 200, 500 V (the measurement range is ±RANGE)	
Measurement probability	±0.5% of RANGE (23°C±5°C, DC coupling, L.P.F. 5 Hz, after zero adjust)	
Temperature coefficient	±(500 ppm of RANGE)/°C (input conversion at 0.1 V RANGE)	
Frequency characteristics	DC coupling	DC to 5 MHz (-3 dB to 1 dB) (with L.P.F. disabled)
	AC coupling	6 Hz to 5 MHz (-3 dB to 1 dB) (with L.P.F. disabled)
Low-pass filter (L.P.F.)	Cutoff frequency	3 Hz, 30 Hz, 300 Hz, 3 kHz, OFF (-3 dB ±1 dB)
Input conversion noise	2 mVp-p max (0.1 V range, input short circuit)	
A/D conversion	A/D resolution	14 bits
	Sampling rate	20 MS/s (max)
Common mode rejection ratio	80 dB or higher (50/60 Hz)	
Maximum allowed input voltage	±500 V peak	
Maximum rated voltage to ground	AC, DC 300 V CAT II (between input terminals and chassis, between channels)	
Withstand voltage	AC 3 kV, 1 minute (between input terminals and chassis, between channels)	
Usage environment	Temperature: 0 to +40°C, humidity: 35 to 85 RH% or less (without condensation)	
Storage environment	Temperature: -20 to +60°C, humidity: 20 to 85 RH% or less (without condensation)	
Dimensions	Approx. 140 mm (W) x 223 mm (H) x 20 mm (D)	
Mass	Approx. 300 g	
Standards	Safety	EN61010-1, EN61010-2-30 Measurement category CAT II, pollution level 2
	EMC	EN61326-1, class A (when mounted to RA3100 main unit)

12.3.4. 16 Channel Logic Module (RA30-105)

Item	Specifications	
Number of input channels	16 ch	
I/O connectors	8 ch x 2 ports	
Input format	Single input, common input (non-insulated), insulation between input signals and chassis	
Voltage detection	Input range	0 to 24 V
	Threshold	Select one of three levels 1.4 V \pm 0.4 V/2.5 V \pm 0.5 V/4 V \pm 0.6 V
	Input impedance	1 M Ω \pm 1%
Contact detection	Threshold	Select one of three levels (High level/low level linked)
	Close (ON)	250 Ω or less/1.5 k Ω or less/3.0 k Ω or less
	Open (OFF)	2.0 k Ω or more/5.0 k Ω or more/9.0 k Ω or more
	Load current	0.5 mA (typ) @ load resistance 0 to 18 k Ω
Response pulse	2 μ s or more	
Sampling rate	1 MS/s	
Maximum allowed input voltage	DC 30 V	
Maximum rated voltage to ground	AC, DC 42 V	
Withstand voltage	AC 300 V, 1 minute (between input terminals and chassis)	
Power output for options	+5 V (\pm 5%)	
Usage environment	Temperature: 0 to +40°C, humidity: 35 to 85 RH% or less (without condensation)	
Storage environment	Temperature: -20 to +60°C, humidity: 20 to 85 RH% or less (without condensation)	
Dimensions	Approx. 140 mm (W) x 223 mm (H) x 20 mm (D)	
Mass	Approx. 250 g	
Standards	Safety	EN61010-1
	EMC	EN61326-1, class A

12.3.5. Two Channel Temperature Module (RA30-106)

Item	Specifications				
Number of input channels	2 ch				
Input connectors	Removable socket (front panel) Temperature sensor connector coupling wire: 0.2 SQ to 1.5 SQ (AWG24 to AWG16)				
Input format	Unbalanced input (insulation between channels and between channels and chassis)				
Input impedance	5 MΩ or higher				
Adaptive sensor	Thermocouple (TC) type	K, E, J, T, N, R, S, B, C (JIS C1602:2015)			
	Platinum resistance temperature detector (RTD)	Pt100, Pt1000 (JIS C1604:2013)			
A/D conversion	A/D resolution	16 bits			
	Data update rate	High speed (1.5 ms), Medium speed (100 ms), Low speed (1 s)			
Thermocouple (TC)					
Reference junction compensation method	Internal/external switching mode				
Internal contact compensation temperature	±1°C (23°C ±5°C) ±1.5°C (full temperature range)				
LFD	Switchable on/off				
Measurement range (RANGE) Measurement probability	Type	Measurement range	Measurement range (°C)	Measurement probability	
	K	200°C 600°C 1370°C	-200 to 200 -200 to 600 -200 to 1370	-200 to 0°C, ±(0.1% of RANGE +2°C) 0 to 1370°C, ±(0.1% of RANGE +1°C)	
	E	200°C 600°C 1000°C	-200 to 200 -200 to 600 -200 to 1000	-200 to 0°C, ±(0.1% of RANGE +2°C) 0 to 1000°C, ±(0.1% of RANGE +1°C)	
	J	200°C 400°C 1100°C	-200 to 200 -200 to 400 -200 to 1100	-200 to 0°C, ±(0.1% of RANGE +2°C) 0 to 1100°C, ±(0.1% of RANGE +1°C)	
	T	100°C 200°C 400°C	-100 to 100 -200 to 200 -200 to 400	-200 to 0°C, ±(0.1% of RANGE +2°C) 0 to 400°C, ±(0.1% of RANGE +1°C)	
	N	200°C 600°C 1300°C	-200 to 200 -200 to 600 -200 to 1300	-200 to 0°C, ±(0.1% of RANGE +2°C) 0 to 1300°C, ±(0.1% of RANGE +1°C)	
	R	200°C 1000°C 1760°C	0 to 200 0 to 1000 0 to 1760	0 to 400°C, ±(0.1% of RANGE +3.5°C) 400 to 1760°C, ±(0.1% of RANGE +3°C)	
	S	200°C 1000°C 1700°C	0 to 200 0 to 1000 0 to 1700	0 to 400°C, ±(0.1% of RANGE +3.5°C) 400 to 1700°C, ±(0.1% of RANGE +3°C)	
	B	600°C 1000°C 1800°C	400 to 600 400 to 1000 400 to 1800	400 to 1800°C, ±(0.1% of RANGE +3°C)	
	C	600°C 1200°C 2300°C	0 to 600 0 to 1200 0 to 2300	0 to 400°C, ±(0.1% of RANGE +3.5°C) 400 to 2300°C, ±(0.1% of RANGE +3°C)	
	Temperature coefficient	(Measurement probability x 0.1)/°C			

12.Specifications – 12.3.Module Specifications

Item	Specifications			
Platinum resistance temperature detector (RTD)				
Measurement method	Three wire method			
Measurement current	Switch between 0.5 mA and 1 mA (when Pt100) Fixed to 0.1 mA (when Pt1000)			
Measurement range (RANGE) Measurement probability	Type	Measurement range	Measurement range (°C)	Measurement probability -200 to 850°C, ±(0.1% of RANGE +0.5°C)
	Pt100	200°C	-200 to 200	
		400°C	-200 to 400	
		850°C	-200 to 850	
	Pt1000	200°C	-200 to 200	
		400°C	-200 to 400	
850°C		-200 to 850		
Temperature coefficient	(Measurement probability x 0.1)/°C			
Common mode rejection ratio	50/60 Hz	Signal source resistance (100 Ω or less)	100 dB (refresh data: low speed, medium speed)	80 dB (refresh data: high speed)
Maximum allowed input voltage	30 V _{peak}			
Maximum rated voltage to ground	AC, DC 300 V (between input and chassis, between channels)			
Withstand voltage	AC 3 kV, 1 minute (between input and chassis, between channels)			
Usage environment	Temperature: 0 to +40°C, humidity: 35 to 85 RH% or less (without condensation)			
Storage environment	Temperature: -20 to +60°C, humidity: 20 to 85 RH% or less (without condensation)			
Dimensions	Approx. 140 mm (W) x 223 mm (H) x 20 mm (D)			
Mass	Approx. 300 g			
Standards	Safety		EN61010-1, EN61010-2-30	
	EMC		EN61326-1, class A (when mounted to RA3100 main unit)	

12.3.6. Remote Control Module (RA30-112)

Item	Specifications
input connectors	Half pitch connector 20 pin
Output connectors	Half pitch connector 14 pin
External input	Function: Controllable via external signal
Control signals	START/STOP, MARK, FEED, PRINT, TRIG
Input level	High level: 2.1 V to 5.0 V, Low level: 0 V to 0.5 V (active low)
Response speed	Switch between high speed/medium speed/low speed
Effective pulse width	For high speed response: High level period 1 μ s or more, low level period 1 μ s or more
	For medium speed response: High level period 1 ms or more, low level period 1 ms or more
	For low speed response: High level period 10 ms or more, low level period 10 ms or more
Maximum allowed input voltage	30 V
External output	Function: Externally output external input control signal START/STOP and TRIG are the OR output with the external input signal and output signal from the RA3100 main unit
Control signals	START/STOP, MARK, FEED, PRINT, TRIG
Output level	High level: 3.8 V to 5.0 V, Low level: 0 V to 0.5 V (active low)
Output pulse width (RA3100 main unit output signal)	START/STOP, FEED, PRINT: Active output during operation period TRIG, MARK, for high speed response: 1 μ s For medium speed response: 1 ms For low speed response: 10 ms
External sampling input	Synchronization possible via external sampling signal (simultaneous SSD and printer recording not possible)
Input level	High level: 2.1 V to 5.0 V, Low level: 0 V to 0.5 V
Effective pulse width	2 μ s or more
Maximum input frequency	SSD recording : 250 kHz Printer recording : 500 Hz
External sampling output	Output external sampling input signal
Output level	High level: 3.8 V to 5.0 V, Low level: 0 V to 0.5 V
Synchronization signal for AC strain input/output	Function : Synchronization signal generator for using AC strain
	Carrier wave : 0 V to 5 V, square wave, 5 kHz
	Synchronization : Synchronization possible with other RA3000 product including RA30-112
Output terminal for waveform confirmation	Function: Square wave signal output for confirming the operation of the voltage input module
Output level	0 V to 5 V (\pm 1%)
Output frequency	1 kHz (\pm 1%)
Duty ratio	50% (\pm 5%)
Withstand voltage	AC 300 V, 1 minute (input, between output and chassis)
Maximum rated voltage to ground	AC, DC 42 V
Usage environment	Temperature: 0 to +40°C, humidity: 35 to 85 RH% or less (without condensation)
Storage environment	Temperature: -20 to +60°C, humidity: 20 to 85 RH% or less (without condensation)
Dimensions	Approx. 140 mm (W) x 223 mm (H) x 20 mm (D)
Mass	Approx. 250 g
Standards	Safety EN61010-1
	EMC EN61326-1, class A

12.4. Exterior

12.4.1. Main Unit Exterior

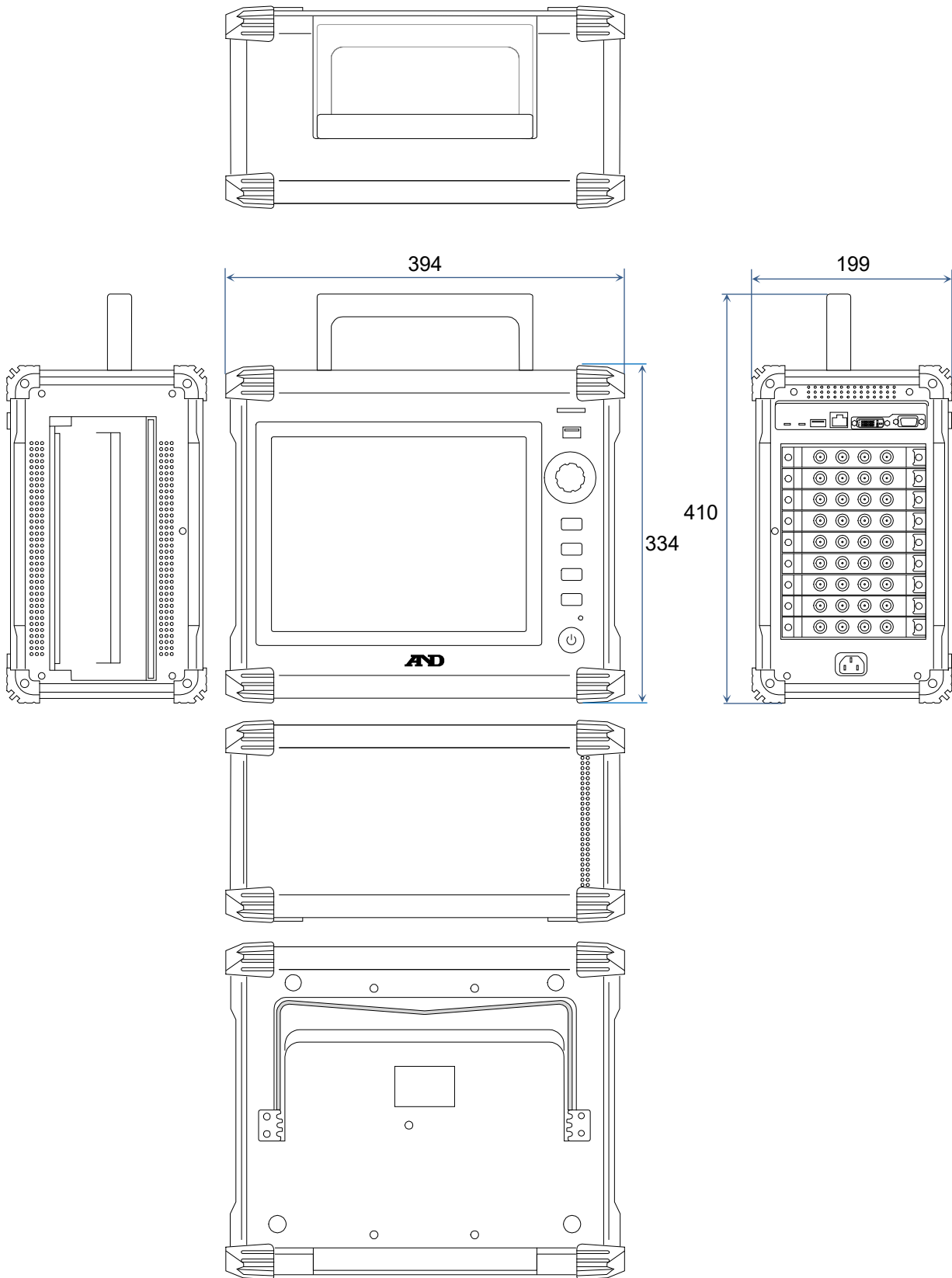

12.4.2. Two Channel Voltage Module (RA30-101) Exterior

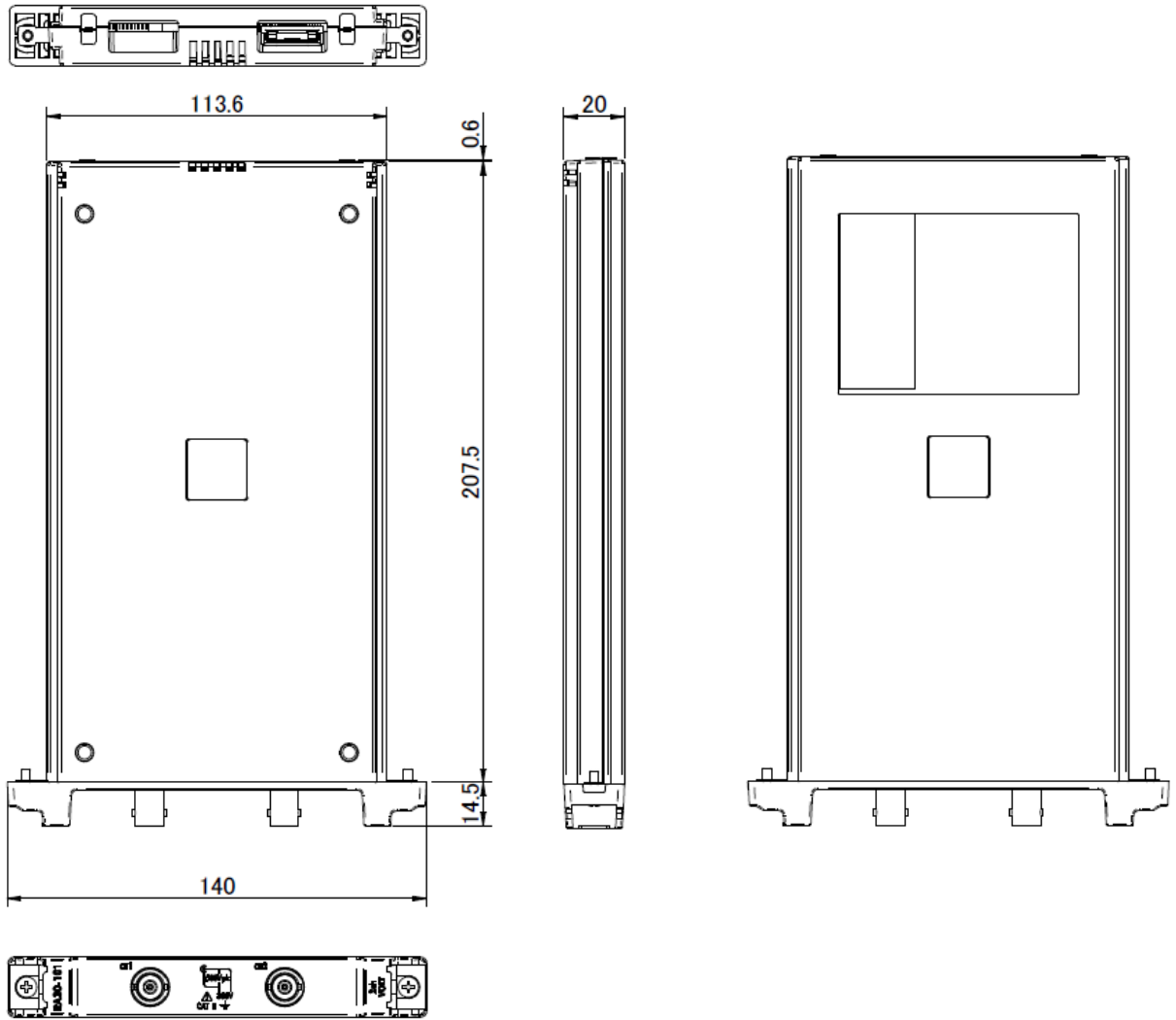

12.4.3. Four Channel Voltage Module (RA30-102) Exterior

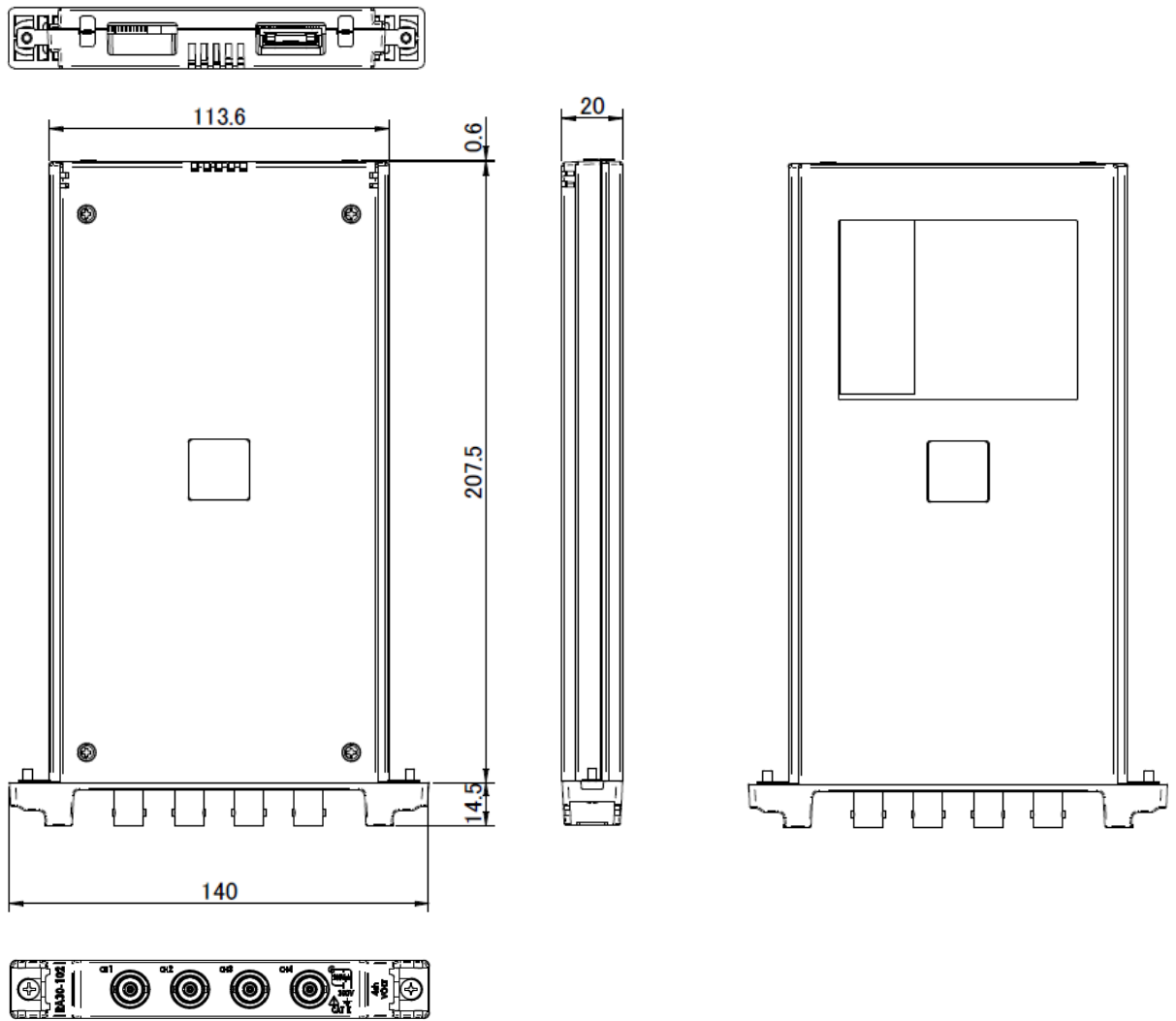

12.4.4. Two Channel High-Speed Voltage Module (RA30-103) Exterior

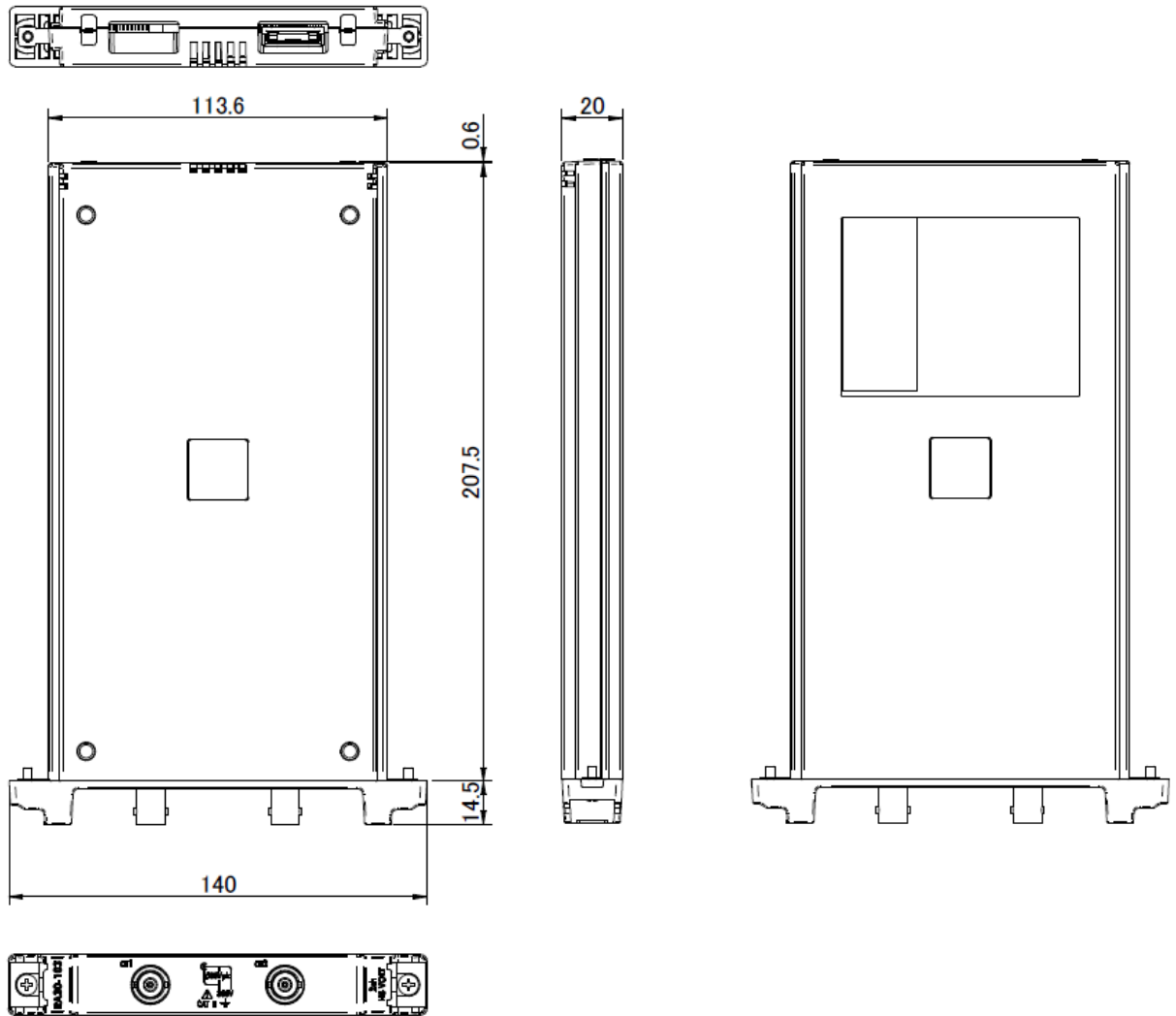

12.4.5. 16 Channel Logic Module (RA30-105) Exterior

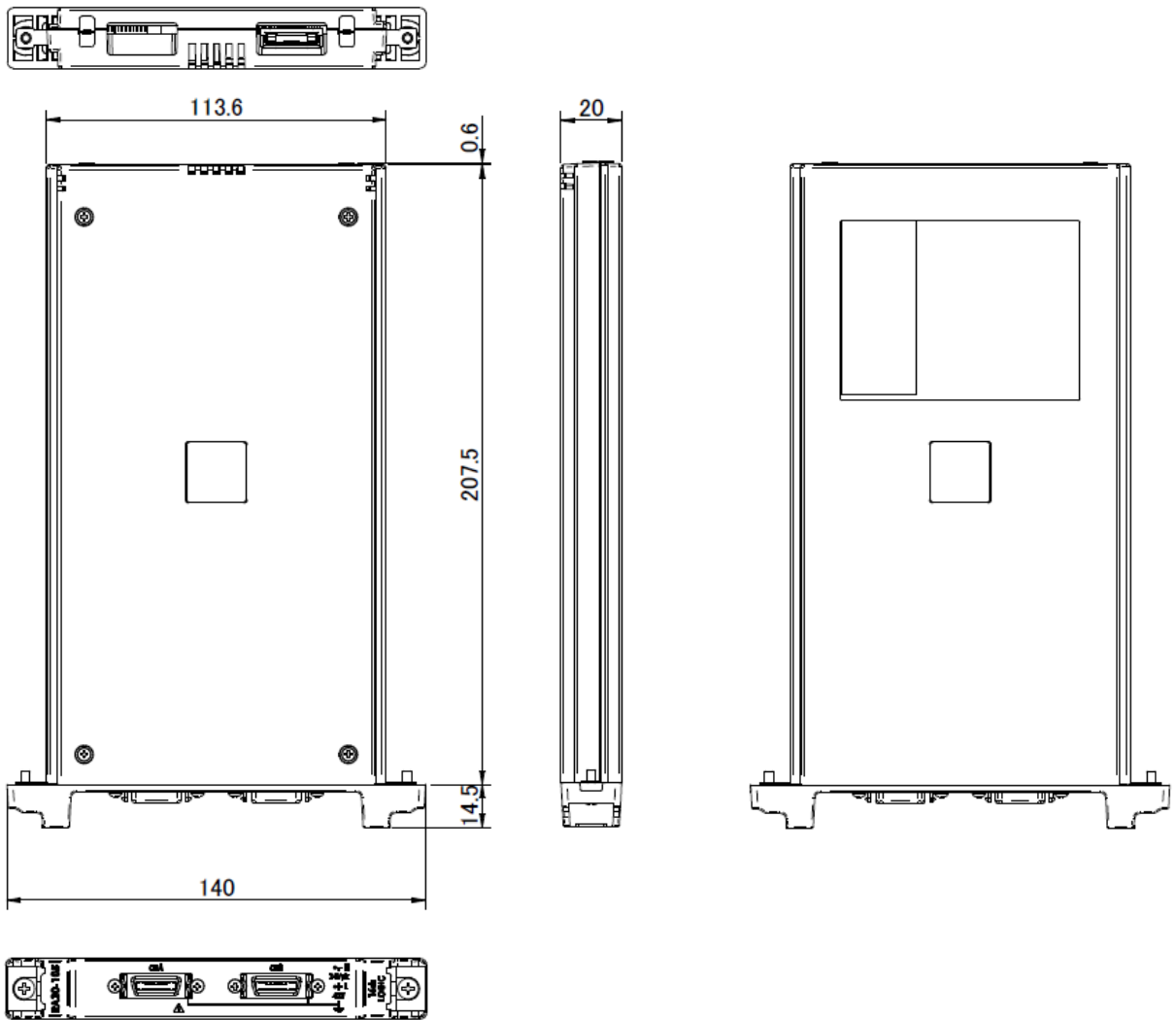

12.4.6. Two Channel Temperature Module (RA30-106) Exterior

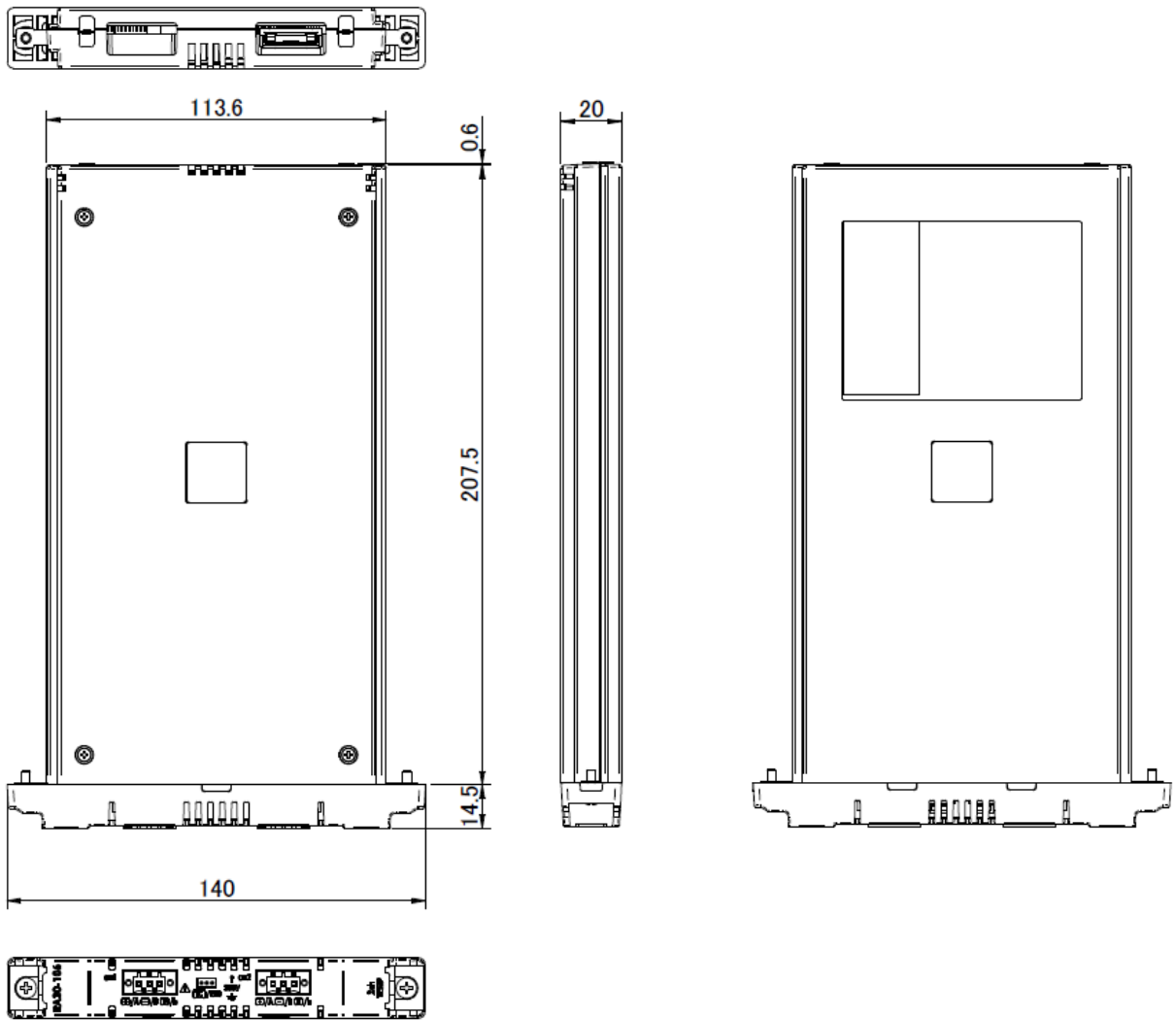

12.4.7. Remote Control Module (RA30-112) Exterior

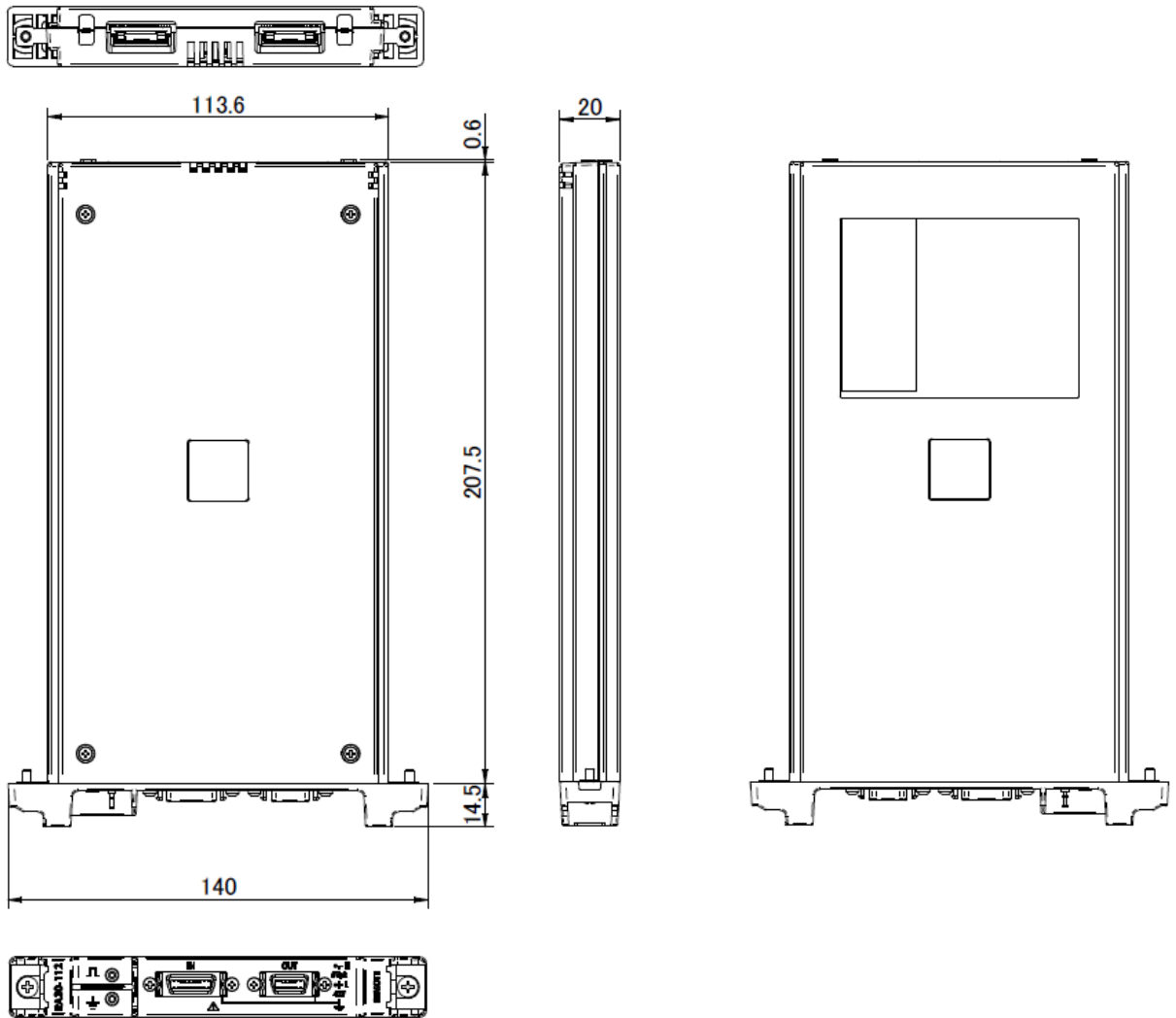

13. Optional Parts

13.1. List of Cables

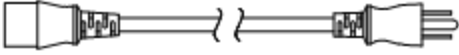
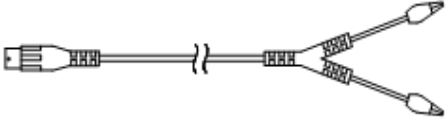
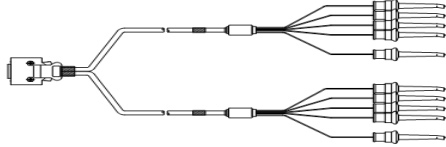
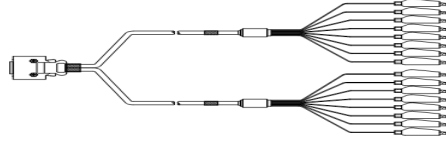
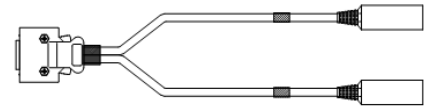
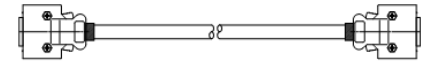
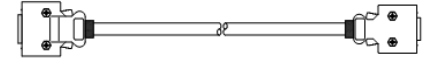
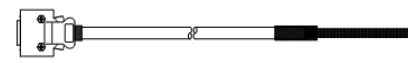
Name (type)	Shape/characteristics	Remarks	
AC power cable 1KO6165-200		AC 125 V system PSE, UL/CSA standard Length 2 m	RA3100 main unit Japan, United States Canada
Insulated BNC cable (alligator clip) RA30-507		Insulated BNC ↕ Safety alligator clip Red + Black - Length 1.5 m + 0.2 m	RA30-101 RA30-102 RA30-103 Analog input
8 channel logic cable (IC clip) RA30-501		For logic input 4 channels x 2, shared ground 1.5 m	RA30-105
8 channel logic cable (alligator clip) RA30-502		For logic input 4 channels x 2 1.5 m	RA30-105
8 channel logic cable (round connector conversion) RA30-503		For 1539S connection Length 0.3 m	RA30-105
Terminal block connection cable RA30-504		For MDR 20 terminal block connection 20P - 20P Length 2 m	RA30-105 RA30-112
Remote control cable (for connecting units) RA30-505		For connecting RA3100 20P - 14P Length 2 m	RA30-112
Remote control cable (discrete wires) RA30-506		For remote control input Length 2 m	RA30-112

13.2. List of Probes/Clamp Meters

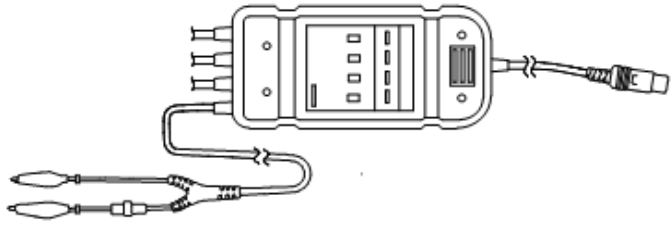
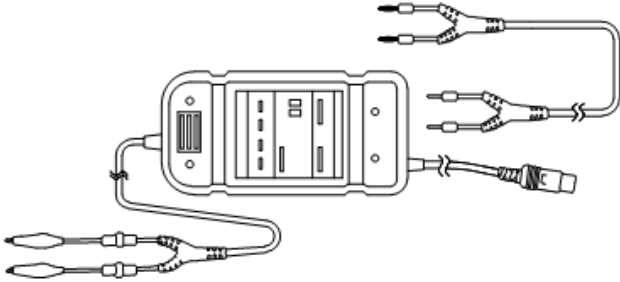
Name (type)	Shape	Remarks
Floating voltage probe (1539S)		4 inputs RA30-105
Voltage variation probe (1540S: AC 100/120 V) (1543S: AC 220/240 V)		1 input RA30-105

13.3. Accessory

Name (type)	Name	Shape	Remarks
RA30-551	Z-fold paper box		Z-fold paper adapter Including RA12-301
RA30-552	Dedicated delivery box		
RA23-183	Carrying case		
RA30-555	Temperature sensor connector		RA30-106 Temperature module input connectors
AX-PCX-10S20	MDR 20 pole terminal block		Connection cable: RA30-504

13.4. List of Spare Parts

Model	Name	Rating	Remarks
YPS106	Recording paper	Paper roll 219.5 mm x 30 m 5 rolls/box	0511-3167 (5 rolls)
YPS108	Recording paper	Paper roll 219.5 mm x 30 m Perforated 150 mm pitch Remaining display print: 300 mm pitch 99 to 00 5 rolls/box	0511-3166 (5 rolls)
YPS112	Recording paper	Z-fold paper 219.5 mm x 200 m folded width 300 mm Remaining display print: 669 to 000 per page 1 book/box	0511-3182
5633-1794	Recording paper holder	2 per set	

Software License Information

The software embedded in this product uses software components owned by third parties.
The license information for the software components embedded in this product is indicated below.

SIL Open Font License

Copyright 2014-2021 Adobe (<http://www.adobe.com/>), with Reserved Font Name 'Source'. Source is a trademark of Adobe in the United States and/or other countries.

This Font Software is licensed under the SIL Open Font License, Version 1.1.

This license is copied below, and is also available with a FAQ at: <http://scripts.sil.org/OFL>

SIL OPEN FONT LICENSE Version 1.1 - 26 February 2007

PREAMBLE

The goals of the Open Font License (OFL) are to stimulate worldwide development of collaborative font projects, to support the font creation efforts of academic and linguistic communities, and to provide a free and open framework in which fonts may be shared and improved in partnership with others.

The OFL allows the licensed fonts to be used, studied, modified and redistributed freely as long as they are not sold by themselves. The fonts, including any derivative works, can be bundled, embedded, redistributed and/or sold with any software provided that any reserved names are not used by derivative works. The fonts and derivatives, however, cannot be released under any other type of license. The requirement for fonts to remain under this license does not apply to any document created using the fonts or their derivatives.

DEFINITIONS

"Font Software" refers to the set of files released by the Copyright Holder(s) under this license and clearly marked as such. This may include source files, build scripts and documentation.

"Reserved Font Name" refers to any names specified as such after the copyright statement(s).

"Original Version" refers to the collection of Font Software components as distributed by the Copyright Holder(s).

"Modified Version" refers to any derivative made by adding to, deleting, or substituting -- in part or in whole -- any of the components of the Original Version, by changing formats or by porting the Font Software to a new environment.

"Author" refers to any designer, engineer, programmer, technical writer or other person who contributed to the Font Software.

PERMISSION & CONDITIONS

Permission is hereby granted, free of charge, to any person obtaining a copy of the Font Software, to use, study, copy, merge, embed, modify, redistribute, and sell modified and unmodified copies of the Font Software, subject to the following conditions:

- 1) Neither the Font Software nor any of its individual components, in Original or Modified Versions, may be sold by itself.
- 2) Original or Modified Versions of the Font Software may be bundled, redistributed and/or sold with any software, provided that each copy contains the above copyright notice and this license. These can be included either as stand-alone text files, human-readable headers or in the appropriate machine-readable metadata fields within text or binary files as long as those fields can be easily viewed by the user.
- 3) No Modified Version of the Font Software may use the Reserved Font Name(s) unless explicit written permission is granted by the corresponding Copyright Holder. This restriction only applies to the primary font name as presented to the users.
- 4) The name(s) of the Copyright Holder(s) or the Author(s) of the Font Software shall not be used to promote, endorse or advertise any Modified Version, except to acknowledge the contribution(s) of the Copyright Holder(s) and the Author(s) or with their explicit written permission.
- 5) The Font Software, modified or unmodified, in part or in whole, must be distributed entirely under this license, and must not be distributed under any other license. The requirement for fonts to remain under this license does not apply to any document created using the Font Software.

TERMINATION

This license becomes null and void if any of the above conditions are not met.

DISCLAIMER

THE FONT SOFTWARE IS PROVIDED "AS IS", WITHOUT WARRANTY OF ANY KIND, EXPRESS OR IMPLIED, INCLUDING BUT NOT LIMITED TO ANY WARRANTIES OF MERCHANTABILITY, FITNESS FOR A PARTICULAR PURPOSE AND NONINFRINGEMENT OF COPYRIGHT, PATENT, TRADEMARK, OR OTHER RIGHT. IN NO EVENT SHALL THE COPYRIGHT HOLDER BE LIABLE FOR ANY CLAIM, DAMAGES OR OTHER LIABILITY, INCLUDING ANY GENERAL, SPECIAL, INDIRECT, INCIDENTAL, OR CONSEQUENTIAL DAMAGES, WHETHER IN AN ACTION OF CONTRACT, TORT OR OTHERWISE, ARISING FROM, OUT OF THE USE OR INABILITY TO USE THE FONT SOFTWARE OR FROM OTHER DEALINGS IN THE FONT SOFTWARE.

Omniace
RA3100

Instruction Manual

1WMPD4004444B

3rd Edition



A&D Company, Limited

3-23-14 Higashi-Ikebukuro, Toshima-ku, Tokyo 170-0013, JAPAN
Telephone: [81] (3) 5391-6132 Fax: [81] (3) 5391-1566

A&D ENGINEERING, INC.

4622 Runway Boulevard Ann Arbor, Michigan 48108, U.S.A.
AMERICAS HEADQUARTERS: Telephone: [1] (800) 726-3364
Weighing, Customer Service: Telephone: [1] (888) 726-5931
Inspection, Customer Service: Telephone: [1] (855) 332-8815

A&D INSTRUMENTS LIMITED

Unit 24/26 Blacklands Way, Abingdon Business Park, Abingdon, Oxfordshire OX14 1DY United Kingdom
Telephone: [44] (1235) 550420 Fax: [44] (1235) 550485

A&D AUSTRALASIA PTY LTD

32 Dew Street, Thebarton, South Australia 5031, AUSTRALIA
Telephone: [61] (8) 8301-8100 Fax: [61] (8) 8352-7409

A&D KOREA Limited

한국에이.엔.디(주)
서울특별시 영등포구 국제금융로6길33 (여의도동) 맨하탄빌딩 817 우편 번호 07331
(817, Manhattan Bldg., 33. Gukjegeumyung-ro 6-gil, Yeongdeungpo-gu, Seoul, 07331 Korea)
전화: [82] (2) 780-4101 팩스: [82] (2) 782-4264

ООО A&D RUS

ООО "Эй энд Ди Рус"

Почтовый адрес: 121357, Российская Федерация, г.Москва, ул. Верейская, дом 17
Юридический адрес: 117545, Российская Федерация, г. Москва, ул. Дорожная, д.3, корп.6, комн. 86
(121357, Russian Federation, Moscow, Vereyskaya Street 17)
тел.: [7] (495) 937-33-44 факс: [7] (495) 937-55-66

A&D Instruments India Private Limited

ऐंडी इन्स्ट्रुमेंट्स इण्डिया प्रा० लिमिटेड

509, उद्योग विहार , फेस -5, गुडगांव - 122016, हरियाणा , भारत
(509, Udyog Vihar, Phase-V, Gurgaon - 122016, Haryana, India)
फोन : [91] (124) 4715555 फैक्स : [91] (124) 4715599

A&D SCIENTECH TAIWAN LIMITED. A&D台灣分公司 艾安得股份有限公司

台湾台北市中正區青島東路5號4樓
(4F No.5 Ching Tao East Road, Taipei Taiwan R.O.C.)
Tel : [886](02) 2322-4722 Fax : [886](02) 2392-1794

A&D INSTRUMENTS (THAILAND) LIMITED

บริษัท เอ แอนด์ ดี อินสตรูमेंท์ (ไทยแลนด์) จำกัด

168/16 หมู่ที่ 1 ตำบลรังสิต อำเภอธัญบุรี จังหวัดปทุมธานี 12110 ประเทศไทย
(168/16 Moo 1, Rangsit, Thanyaburi, Pathumthani 12110 Thailand)
Tel : [66] 20038911